

SWITCH
LOGIQ



TEM

SVEPRISUTNO SAMOPOUZDANJE **Napravljeno za bilo koji prostor**

Dizajn koji je prikladan za svaki prostor. Univerzalne linije sklopki ostavljaju svoj pečat u modernim radnim okruženjima ili u toplijim prostorima vašeg doma. Za svaku vašu želju obitelj sklopki LOGIQ nudi vam jednostavno i logično rješenje.

OMNIPRESENT CONFIDENCE **made for every room**

A shape for every room. The switches have universal lines that leave a mark in both modern work environments as well as in cosy, comfortable living spaces. The LOGIQ family offers a simple and logical solution for your every wish.



HARMONIJA BOJA Odaberite svoju nijansu

Obitelj LOGIQ odlikuje se logičnim izborom provjerenih i elegantnih nijansi boja koje korisnici najviše vole. Vi se ne morate prilagođavati, LOGIQ linija prilagođava se vama tako da uvijek možemo izraditi ton boje prilagođen vašim posebnim željama. Logično.

H A R M O N Y O F C O L O U R S C h o o s e y o u r h u e

The LOGIQ family prides itself on its logical range of verified and elegant hues known and loved by our clients. Don't compromise, the LOGIQ family has you covered. We can always create the hue of colour in accordance with your special request. Logically.

■ **antracit /**
anthracite

■ **titan /**
titanium

■ **bijela-sjaj /**
polar white



NEOGRANIČENA MAŠTA

Sastavi svoju kombinaciju

LIMITLESS IMAGINATION

Create your own combination

Obitelj LOGIQ omogućuje vam sastavljanje proizvoljnih kombinacija. Za jednostavno kombiniranje za vas smo izradili koristan dodatak koji će vam olakšati nizanje vodoravnih i okomitih linija. Takozvani sustav 55/55 omogućuje vam da se uvijek koristite istim univerzalnim elementima. Zna li što želite? Ne brinite se, LOGIQ sklopke čitaju vaše misli.

The LOGIQ family allows you to create your own combination. To make combining simple, we have created a useful system that supports the sequencing of horizontal and vertical lines. The so-called 55/55 system allows you to use the same universal elements every time. Know what you want? Don't worry, the LOGIQ switches can read your mind.



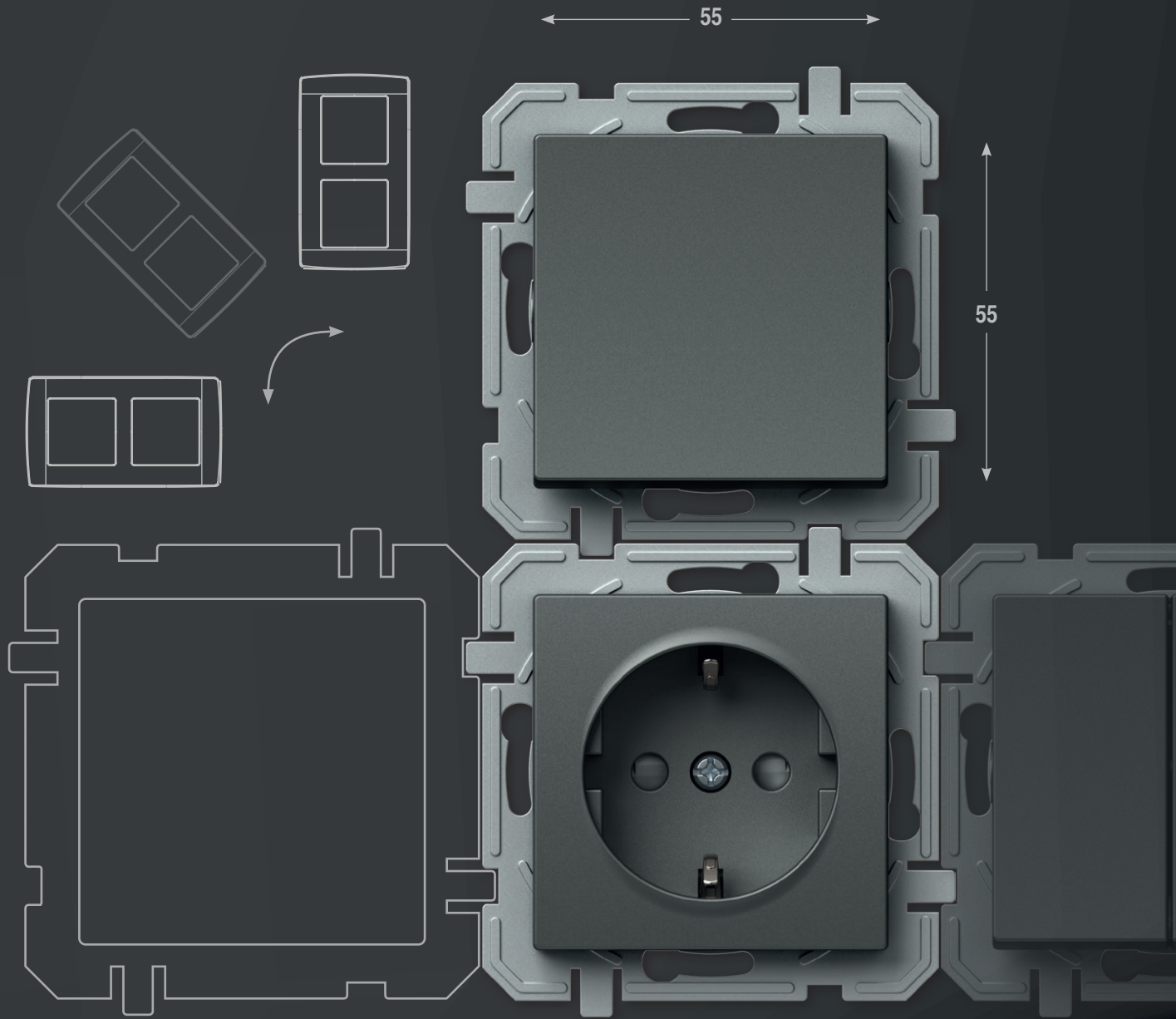

JEDNOSTAVNO ZA NAJZAHTJEVNIJE

Obitelj LOGIQ su sklopke, regulatori, senzori, utičnice za sve svrhe i sve na jednome mjestu. Možete ih rabiti pojedinačno ili u nizu. Kao i svaka obitelj koja raste i razvija se, i dalje ćemo razvijati našu ponudu u skladu s vašim potrebama i željama. Volimo osluškovati vaše želje i nudimo vam rješenje koje će biti jednostavan i logičan nastavak priče obitelji LOGIQ.

SIMPLE FOR THE MOST DEMANDING

The LOGIQ family offers switches, regulators, sensors, and sockets for every purpose in one place. You can use these products individually or in a sequence. Just like every family that grows and develops, the LOGIQ family will continue to develop our range of products in accordance with your needs and wishes. We are happy to listen to you and offer a solution which will simply and logically continue the story of the LOGIQ family.



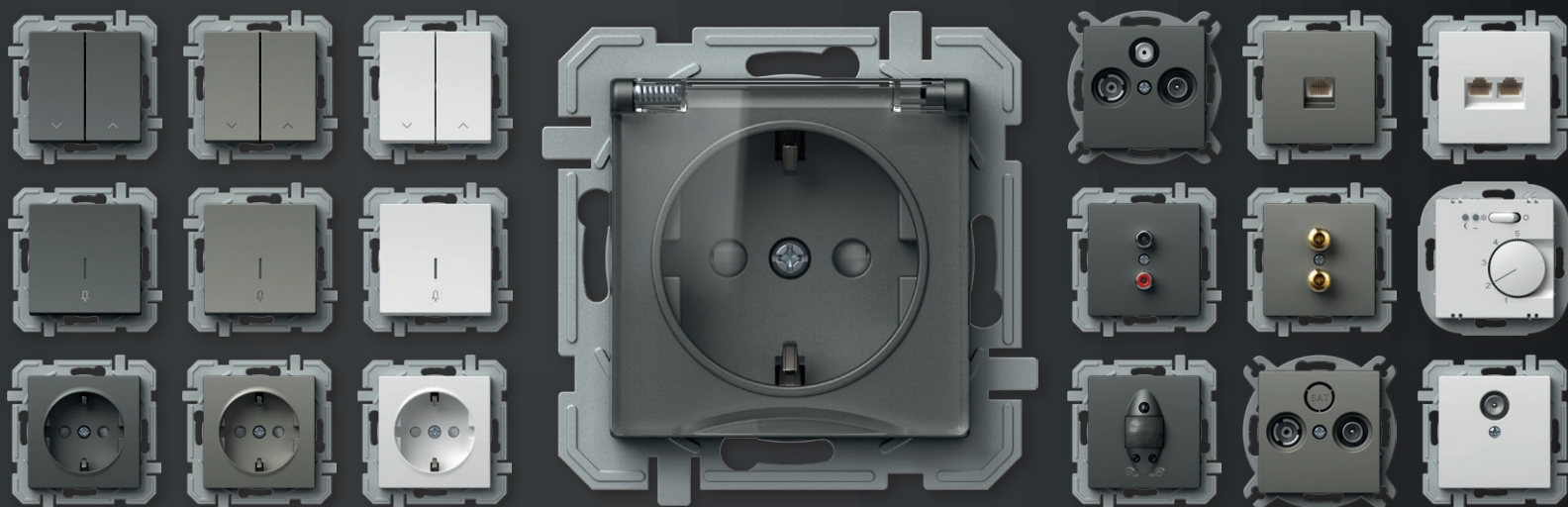

SVE NA JEDNOME MJESTU I VIŠE
ALL IN ONE PLACE AND MORE

LOGIČNA UGRADNJA

LOGICAL INSTALLATION

LOGIQ je rješenje za sustav standardnih okruglih doza. S pomoću njega možete planirati jednostavne i zahtjevne instalacije, novogradnje i adaptacije. Sustav karakteriziraju bezvijačani kontakti, koji vam štede vrijeme tijekom ugradnje elemenata.

LOGIQ is a solution for the system of standardized round installations boxes. It can be used for simple as well as more demanding installations, new buildings and adaptations. The system is characterised by plug-in contacts which save time during installation of elements.

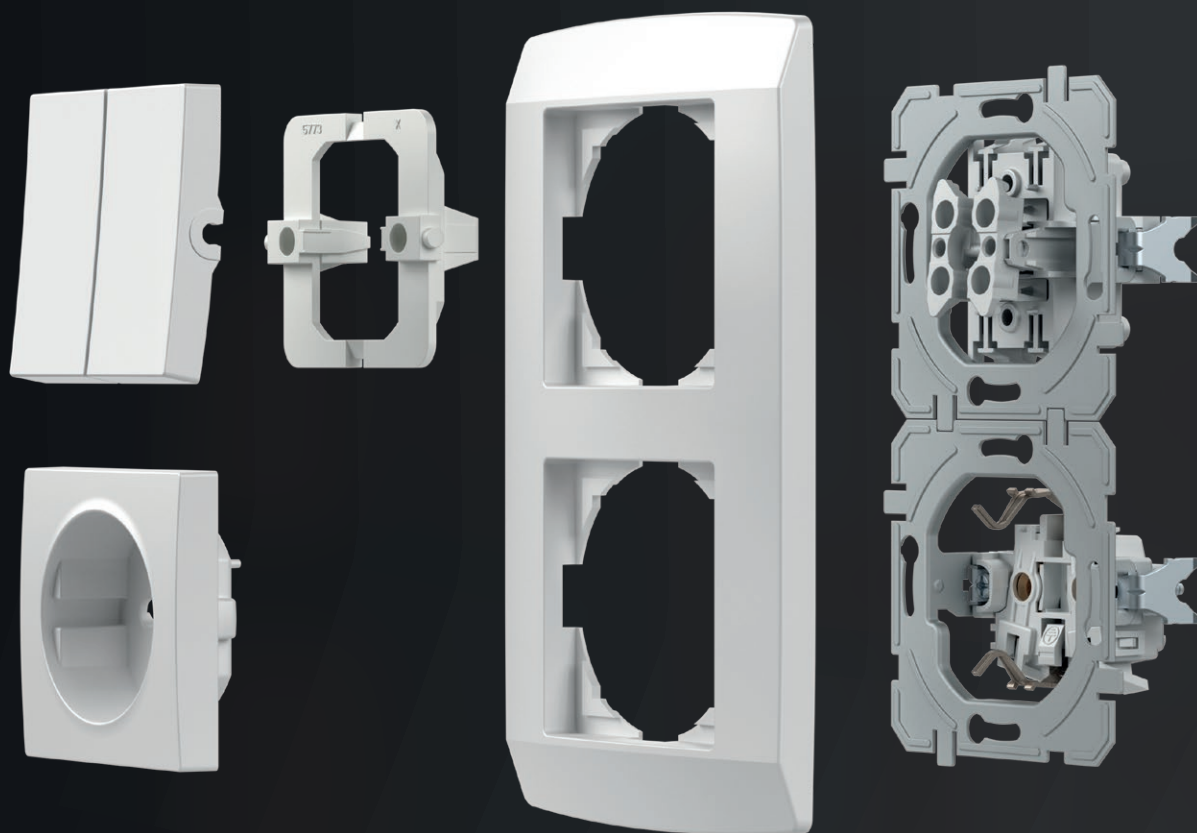

DOBRO JE ZNATI GOOD TO KNOW



Sve utičnice imaju ugrađenu zaštitu od dodira elemenata pod naponom.

All the sockets are equipped with a safety shutters assuring the protection to live contacts.



Dobro osmišljena konstrukcija sklopki omogućuje jednostavno naknadno osvjetljenje.

A well-planned switch construction makes easy illumination possible also subsequently.



Pouzdanost preklopa osiguravaju kontakti od legura srebra (AgNi).

Contacts made of silver alloy (Ag-Ni) guarantee safe switching.



Bezvijčani kontakti omogućuju brzo i pouzdano spajanje vodiča. Na isti kontakt možete pričvrstiti dva vodiča različitih promjera.

Plug-in contacts enable quick and reliable attachment of wires. Two wires of different diameters can be attached to the same contact.



Nožice omogućuju dublje pričvršćivanje (također preko keramičkih pločica itd.)

Fixing claws enable deeper fixing (also through ceramic tiles, etc.)



Sastavljive doze olakšat će vam rad. Prave udaljenosti su vam zajamčene.

Easy-fitting installation boxes will make your work easier. Proper lengths are guaranteed.

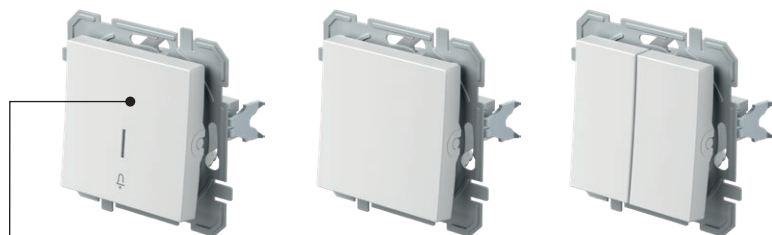







SQ11

PW

IN

01

XO

tip type	naziv description	tehnički opis technical data	boja colour	opcijski opis 1 optional data 1	opcijski opis 2 optional data 2	opcijski opis 3 optional data 3
SQ10	SKLOPKA JEDNOPOLNA SWITCH 1WAY	10AX 250V~	□ PW bijela – sjaj polar white	 NT neutralna neutral	 01	XO bez okvira without cover plate
SQ11	TIPKALO JEDNOPOLNO PUSH BUTTON 1WAY	10A 250V~	■ TI titan titanium	 IN indikator indicator	 02	
SQ22	SKLOPKA DVOPOLNA SWITCH 2POLE	16AX 250V~	■ AT antracit anthracite	 IN indikator indicator	 03	
.	□.
.

SKLOPKA JEDNOPOLNA 10AX 250V~

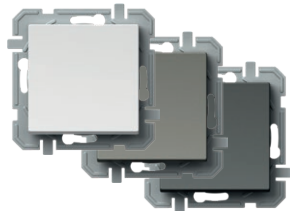

- SQ10PWXO
- SQ10TIXO
- SQ10ATXO



- 10AX 250V~, tip SQ10
- usklađeno s normom EN 60669-1
- bezvijčano pričvršćivanje vodiča 1.5-2.5mm²

SWITCH 1WAY 10AX 250V~

- 10AX 250V~, type SQ10
- in accordance with EN 60669-1
- plug-in contacts 1.5-2.5mm²



SKLOPKA JEDNOPOLNA 10AX 250V~ __ IN



- SQ10PWINXO
- SQ10TIINXO
- SQ10ATINXO



- IN indikator, bez neonske tinjalice
- 10AX 250V~, tip SQ10
- usklađeno s normom EN 60669-1
- bezvijčano pričvršćivanje vodiča 1.5-2.5mm²

SWITCH 1WAY 10AX 250V~ __ IN

- IN indicator, without neon lamp
- 10AX 250V~, type SQ10
- in accordance with EN 60669-1
- plug-in contacts 1.5-2.5mm²



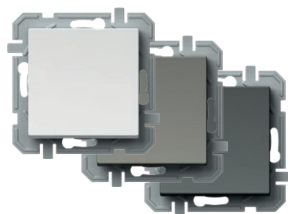

- SQ11PWXO
- SQ11TIXO
- SQ11ATXO

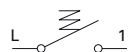

TIPKALO JEDNOPOLNO 10A 250V~

- 10A 250V~, tip SQ11
- usklađeno s normom EN 60669-1
- bezvijačno pričvršćivanje vodiča 1.5-2.5mm²

PUSH BUTTON 1WAY 10A 250V~

- 10A 250V~, type SQ11
- in accordance with EN 60669-1
- plug-in contacts 1.5-2.5mm²



- SQ11PWIN01XO
- SQ11TIIN01XO
- SQ11ATIN01XO

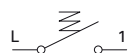

TIPKALO JEDNOPOLNO 10A 250V~ __ IN 01

- IN 01 indikator zvona, bez neonske tinjalice
- 10A 250V~, tip SQ11
- usklađeno s normom EN 60669-1
- bezvijačno pričvršćivanje vodiča 1.5-2.5mm²

PUSH BUTTON 1WAY 10A 250V~ __ IN 01

- IN 01 indicator bell, without neon lamp
- 10A 250V~, type SQ11
- in accordance with EN 60669-1
- plug-in contacts 1.5-2.5mm²



- SQ11PWIN02XO
- SQ11TIIN02XO
- SQ11ATIN02XO

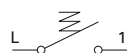

TIPKALO JEDNOPOLNO 10A 250V~ __ IN 02

- IN 02 indikator svjetla, bez neonske tinjalice
- 10A 250V~, tip SQ11
- usklađeno s normom EN 60669-1
- bezvijačno pričvršćivanje vodiča 1.5-2.5mm²

PUSH BUTTON 1WAY 10A 250V~ __ IN 02

- IN 02 indicator light, without neon lamp
- 10A 250V~, type SQ11
- in accordance with EN 60669-1
- plug-in contacts 1.5-2.5mm²



- SQ22PWIN03XO
- SQ22TIIN03XO
- SQ22ATIN03XO

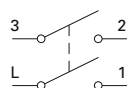

SKLOPKA DVOPOLNA 16AX 250V~ __ IN 03

- IN 03 neutralna 0-1, bez neonske tinjalice
- 16AX 250V~, tip SQ22
- usklađeno s normom EN 60669-1
- vijčano pričvršćivanje vodiča 1.5-2.5mm²

SWITCH 2POLE 16AX 250V~ __ IN 03

- IN 03 neutral 0-1, without neon lamp
- 16AX 250V~, type SQ22
- in accordance with EN 60669-1
- screw contacts 1.5-2.5mm²

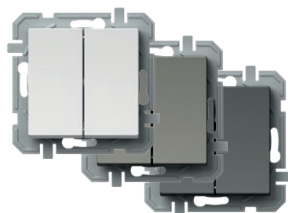

- SQ50PWXO
- SQ50TIXO
- SQ50ATXO

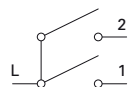

SKLOPKA SERIJSKA 10AX 250V~

- 10AX 250V~, tip SQ50
- usklađeno s normom EN 60669-1
- bezvijačno pričvršćivanje vodiča 1.5-2.5mm²

SWITCH 2GANG-1WAY 10AX 250V~

- 10AX 250V~, type SQ50
- in accordance with EN 60669-1
- plug-in contacts 1.5-2.5mm²





- SQ51PWXO
- SQ51TIXO
- SQ51ATXO

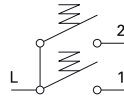

TIPKALO SERIJSKO 10A 250V~

- 10A 250V~, tip SQ51
- usklađeno s normom EN 60669-1
- bezvijačno pričvršćivanje vodiča 1.5-2.5mm²

PUSH BUTTON 2GANG-1WAY 10A 250V~

- 10A 250V~, type SQ51
- in accordance with EN 60669-1
- plug-in contacts 1.5-2.5mm²



- SQ52PWNT09XO
- SQ52TINT09XO
- SQ52ATNT09XO

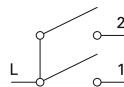

SKLOPKA ŽALUZIJSKA 10AX 250V~ __ NT 09

- NT 09 neutralna gore-dolje
- 10AX 250V~, tip SQ52
- usklađeno s normom EN 60669-1
- bezvijačno pričvršćivanje vodiča 1.5-2.5mm²
- s mehaničkim blokiranjem istodobnog uključivanja

SWITCH SHUTTERS 10AX 250V~ __ NT 09

- NT 09 neutral up-down
- 10AX 250V~, type SQ52
- in accordance with EN 60669-1
- plug-in contacts 1.5-2.5mm²
- with mechanical interblock



- SQ53PWNT09XO
- SQ53TINT09XO
- SQ53ATNT09XO

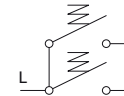

TIPKALO ŽALUZIJSKO 10A 250V~ __ NT 09

- NT 09 neutralna gore-dolje
- 10A 250V~, tip SQ53
- usklađeno s normom EN 60669-1
- bezvijačno pričvršćivanje vodiča 1.5-2.5mm²
- s mehaničkim blokiranjem istodobnog uključivanja

PUSH BUTTON SHUTTERS 10A 250V~ __ NT 09

- NT 09 neutral up-down
- 10A 250V~, type SQ53
- in accordance with EN 60669-1
- plug-in contacts 1.5-2.5mm²
- with mechanical interblock

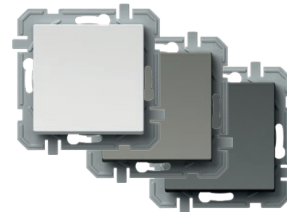

- SQ60PWXO
- SQ60TIXO
- SQ60ATXO

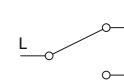

SKLOPKA IZMJENIČNA 10AX 250V~

- 10AX 250V~, tip SQ60
- usklađeno s normom EN 60669-1
- bezvijačno pričvršćivanje vodiča 1.5-2.5mm²

SWITCH 2WAY 10AX 250V~

- 10AX 250V~, type SQ60
- in accordance with EN 60669-1
- plug-in contacts 1.5-2.5mm²

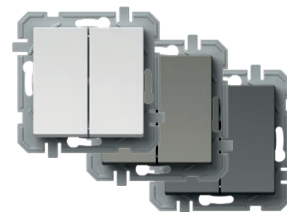

- SQ63PWXO
- SQ63TIXO
- SQ63ATXO



SKLOPKA IZMJENIČNA DVOSTRUKA 10AX 250V~

- 10AX 250V~, tip SQ63
- usklađeno s normom EN 60669-1
- bezvijačno pričvršćivanje vodiča 1.5-2.5mm²

SWITCH DOUBLE 2WAY 10AX 250V~

- 10AX 250V~, type SQ63
- in accordance with EN 60669-1
- plug-in contacts 1.5-2.5mm²



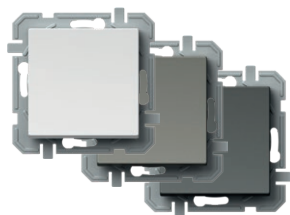

- SQ70PWXO
- SQ70TIXO
- SQ70ATXO



SKLOPKA KRIŽNA 10AX 250V~

- 10AX 250V~, tip SQ70
- usklađeno s normom EN 60669-1
- bezvijčano pričvršćivanje vodiča 1.5-2.5mm²

SWITCH INTERMEDIATE 10AX 250V~

- 10AX 250V~, type SQ70
- in accordance with EN 60669-1
- plug-in contacts 1.5-2.5mm²



SQ10
SQ11

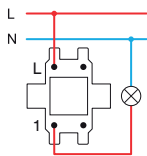

SQ22

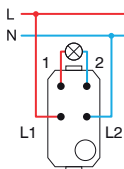

SQ50
SQ51

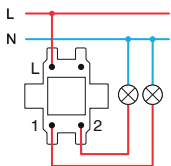

SQ52
SQ53

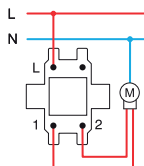

SQ60+SQ60

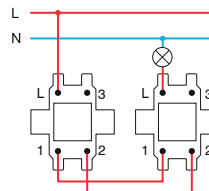

SQ63+SQ63

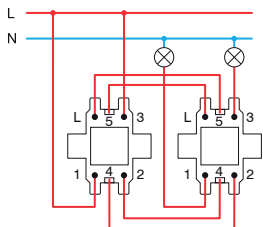

SQ60+SQ70+SQ60

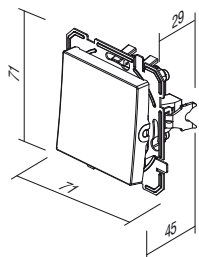
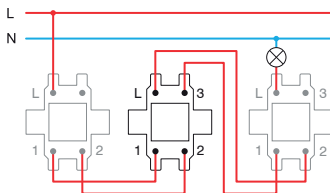

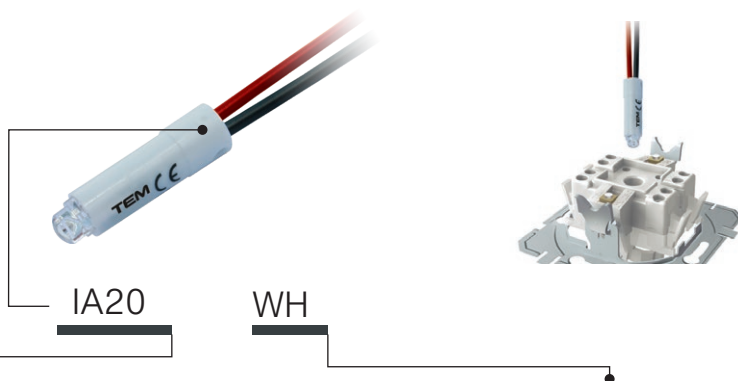

tip type	naziv description	tehnički opis technical data	boja colour
IA10	NEONSKA TINJALICA NEON LAMP	230V~ 0,34W	<input type="checkbox"/> WH bijela white
IA20	LED TINJALICA LED LAMP	230V~ 0,40W	<input checked="" type="checkbox"/> BL plava blue
IA21	LED TINJALICA LED LAMP	24V AC/DC 0,20W	<input checked="" type="checkbox"/> RD crvena red
.	.	.	<input checked="" type="checkbox"/> GR zelena green
.	.	.	<input checked="" type="checkbox"/> OR narančasta orange

NEONSKA TINJALICA 230V~ 0,34W

IA10OR

- za indicaciju, osvetljenje ili stalno osvetljenje sklopke
- u kombinaciji s tipkom s indikatorom

NEON LAMP 230V~ 0,34W

- for indication, illumination or constant illumination of switch
- in combination with button with indicator

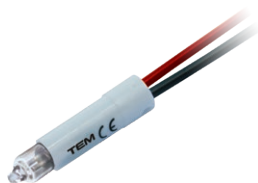

LED TINJALICA 230V AC/DC 0,40W

IA20WH
 IA20GR
 IA20RD
 IA20BL

- za indicaciju, osvetljenje ili stalno osvetljenje sklopke
- u kombinaciji s tipkom s indikatorom

LED LAMP 230V AC/DC 0,40W

- for indication, illumination or constant illumination of switch
- in combination with button with indicator

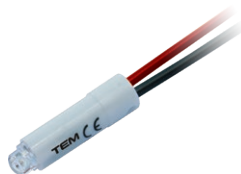

LED TINJALICA 24V AC/DC 0,20W

IA21WH
 IA21RD

- za indicaciju, osvetljenje ili stalno osvetljenje sklopke
- u kombinaciji s tipkom s indikatorom

LED LAMP 24V AC/DC 0,20W

- for indication, illumination or constant illumination of switch
- in combination with button with indicator

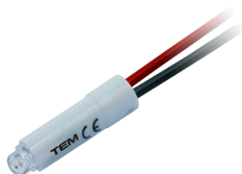

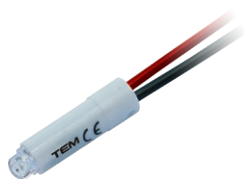

- IA22WH
- IA22RD

LED TINJALICA 12V AC/DC 0,10W

- za indicaciju, osvjetljenje
- ili stalno osvjetljenje sklopke
- u kombinaciji s tipkom s indikatorom

LED LAMP 12V AC/DC 0,10W

- for indication, illumination or
- constant illumination of switch
- in combination with button with indicator

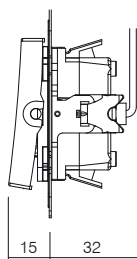

* Indikacija /
Indication

Osvjetljenje /
Illumination

* Stalno osvjetljenje
Illumination always on

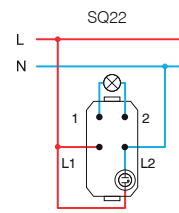
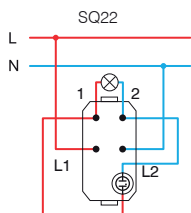
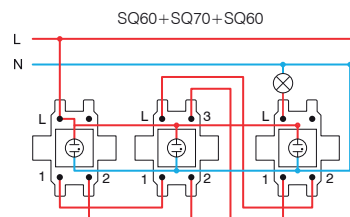
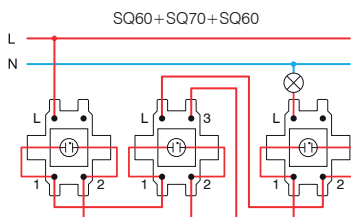
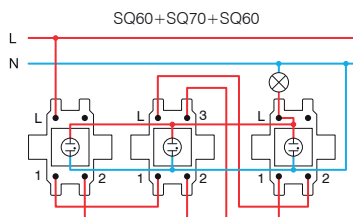
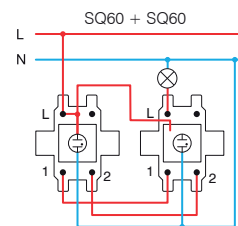
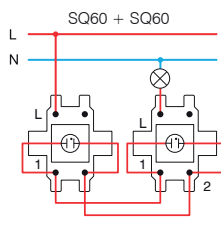
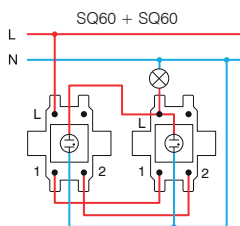
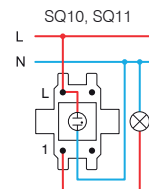
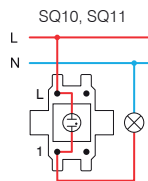
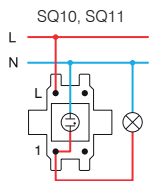

* spajanje prikladno za štedljive (CFL, LED) tinjalice /
wiring scheme for energy saving lamps (CFL, LED)

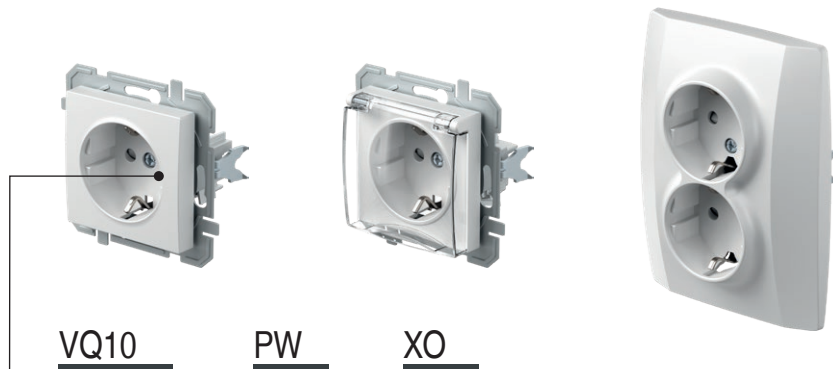

tip <i>type</i>	naziv <i>description</i>	tehnički opis <i>technical data</i>	opcijski podatci 1 <i>optional data 1</i>
VQ10	UTIČNICA ŠUKO SOCKET SCHUKO	2P+E 16A 250V~	XO bez okvira without cover plate
VQ11	UTIČNICA ŠUKO+POKLOPAC SOCKET SCHUKO+COVER	2P+E 16A 250V~	
VQ12	UTIČNICA ŠUKO SOCKET SCHUKO	2P+E 16A 250V~ BV	
:	:	:	
:	:	:	

boja
colour

<input type="checkbox"/> PW	bijela – sjaj <i>polar white</i>	<input type="checkbox"/> PT	bijela+prozirna <i>white+transparent</i>	<input type="checkbox"/> PP	bijela+bijela <i>white+white</i>
<input type="checkbox"/> TI	titan <i>titanium</i>	<input type="checkbox"/> TT	titan+prozirna <i>titanium+transparent</i>	<input type="checkbox"/> TI	titan+titan <i>titanium+titanium</i>
<input type="checkbox"/> AT	antracit <i>anthracite</i>	<input type="checkbox"/> AT	antracit+prozirna <i>anthracite+transparent</i>	<input type="checkbox"/> AA	antracit+antracit <i>anthracite+anthracite</i>
<input type="checkbox"/> RD	crvena <i>red</i>	<input type="checkbox"/> RT	crvena+prozirna <i>red+transparent</i>	<input type="checkbox"/> RR	crvena+crvena <i>red+red</i>
<input type="checkbox"/> GR	zelena <i>green</i>	<input type="checkbox"/> GT	zelena+prozirna <i>green+transparent</i>	<input type="checkbox"/> GG	zelena+zelena <i>green+green</i>
<input type="checkbox"/> OR	narančasta <i>orange</i>	<input type="checkbox"/> OT	narančasta+prozirna <i>orange+transparent</i>	<input type="checkbox"/> OO	narančasta+narančasta <i>orange+orange</i>



šuko – usklađen s normom EN 60884-1, CEE7 (lista standarda III)

schuko - in accordance with EN 60884-1, CEE7 (standard sheet III)

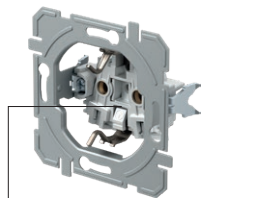

vijčano pričvršćivanje vodiča
screw contacts

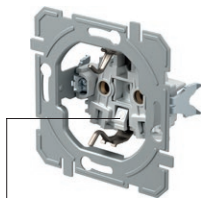

BV bezvijčano pričvršćivanje vodiča
BV plug-in contacts

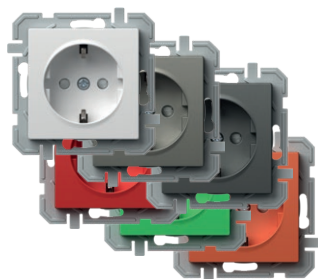

- VQ10PWXO
- VQ10TIXO
- VQ10ATXO
- VQ10RDXO
- VQ10GRXO
- VQ10ORXO

UTIČNICA ŠUKO 2P+E 16A 250V~ __ XO

- vijčano pričvršćivanje vodiča 1.5-2.5mm²
- XO bez okvira
- 2P+E šuko
- 16A 250V~, tip VQ10
- KS ugrađena dječja zaštita od dodira kontakta

SOCKET SCHUKO 2P+E 16A 250V~ __ XO

- screw contacts 1.5-2.5mm²
- XO without surround
- 2P+E schuko
- 16A 250V~, type VQ10
- KS build-in child protection – shuttered live contacts

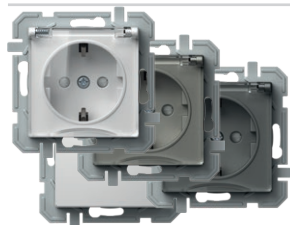

- VQ11PTXO
- VQ11TTXO
- VQ11ATXO
- VQ11PPXO

UTIČNICA ŠUKO+POKLOPAC 2P+E 16A 250V~ __ XO

- vijčano pričvršćivanje vodiča 1.5-2.5mm²
- XO bez okvira
- 2P+E šuko+poklopac
- 16A 250V~, tip VQ11
- KS ugrađena dječja zaštita od dodira kontakta

SOCKET SCHUKO+COVER 2P+E 16A 250V~ __ XO

- screw contacts 1.5-2.5mm²
- XO without surround
- 2P+E schuko+cover
- 16A 250V~, type VQ11
- KS build-in child protection – shuttered live contacts

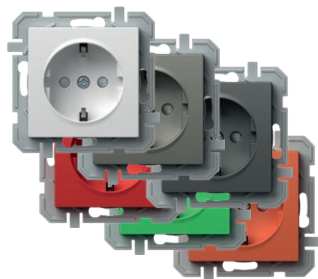

- VQ12PWXO
- VQ12TIXO
- VQ12ATXO
- VQ12RDXO
- VQ12GRXO
- VQ12ORXO

UTIČNICA ŠUKO 2P+E 16A 250V~ BV __ XO

- BV bezvijčano pričvršćivanje vodiča 1.5-2.5mm²
- XO bez okvira
- 2P+E šuko
- 16A 250V~, tip VQ12
- KS ugrađena dječja zaštita od dodira kontakta

SOCKET SCHUKO 2P+E 16A 250V~ BV __ XO

- BV plug-in contacts 1.5-2.5mm²
- XO without surround
- 2P+E schuko
- 16A 250V~, type VQ12
- KS build-in child protection – shuttered live contacts



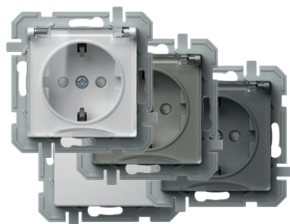

- VQ13PTXO
- VQ13TTXO
- VQ13ATXO
- VQ13PPXO

UTIČNICA ŠUKO+POKLOPAC 2P+E 16A 250V~ BV __ XO

- BV bezvijčano pričvršćivanje vodiča 1.5-2.5mm²
- XO bez okvira
- 2P+E šuko+poklopac
- 16A 250V~, tip VQ13
- KS ugrađena dječja zaštita od dodira kontakta



SOCKET SCHUKO+COVER 2P+E 16A 250V~ BV __ XO

- BV plug-in contacts 1.5-2.5mm²
- XO without surround
- 2P+E schuko+cover
- 16A 250V~, type VQ13
- KS build-in child protection – shuttered live contacts



- VQ16PW
- VQ16TI
- VQ16AT

UTIČNICA ŠUKO DVOSTRUKA 2P+E 16A 250V~

- 2P+E šuko dvostruka
- 16A 250V~, tip VQ16
- usklađeno s normom IEC 60884-1, CEE7
- vijčano pričvršćivanje vodiča 1.5-2.5mm²
- KS ugrađena dječja zaštita od dodira kontakta

SOCKET SCHUKO DOUBLE 2P+E 16A 250V~

- 2P+E schuko double
- 16A 250V~, type VQ16
- in accordance with IEC 60884-1, CEE7
- screw contacts 1.5-2.5 mm²
- KS build-in child protection – shuttered live contacts

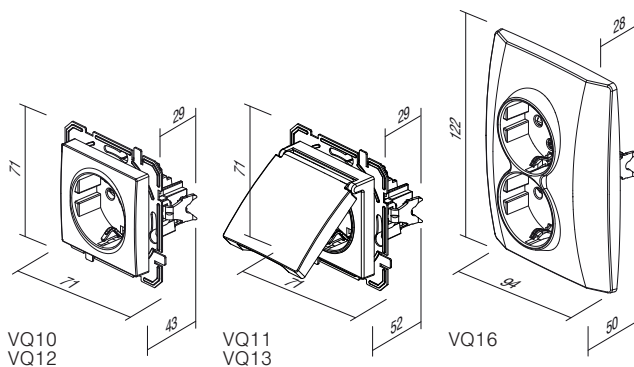



KQ37

PW

XO

tip type	naziv description	tehnički opis technical data	boja colour	opcijski opis 1 optional data 1
KQ11	UTIČNICA TV-R ZAVRŠNA SOCKET TV-R END-LINE	1dB	<input type="checkbox"/> PW bijela – sjaj polar white	XO bez okvira without cover plate
KQ12	UTIČNICA TV-R PROLAZNA SOCKET TV-R THROUGHPASS	10dB	<input type="checkbox"/> TI titan titanium	
KQ16	UTIČNICA SAT-TV-R ZAVRŠNA SOCKET SAT-TV-R END-LINE	3dB	<input type="checkbox"/> AT antracit anthracite	
⋮	⋮	⋮		

UTIČNICA TV OSNOVNA 0dB



- KQ10PWXO
- KQ10TIXO
- KQ10ATXO

- TV osnovna
- prigušenje 0dB
- stražnji konektor – F standard

SOCKET TV BASIC 0dB
- TV basic
- reduction 0dB
- back connector – F standard



UTIČNICA TV-R ZAVRŠNA 1dB



- KQ11PWXO
- KQ11TIXO
- KQ11ATXO

- TV-R završna
- frekvenjski raspon 5÷862 MHz
- prigušenje: R-1.5dB, TV-1dB
- usklađeno s normom EN 50083-1
- vijčano priključenje

SOCKET TV-R END-LINE 1dB
- TV-R end-line
- frequency range 5÷862 MHz
- reduction: R-1.5dB, TV-1dB
- in accordance with EN 50083-1
- screw contact





- KQ12PWXO
- KQ12TIXO
- KQ12ATXO

UTIČNICA TV-R PROLAZNA 10dB

- TV-R prolazna
- frekvenjski raspon 5÷862 MHz
- prigušenje: R-10dB, TV-10dB, prolaznost-2dB
- usklađeno s normom EN 50083-1
- vijčano priključenje

SOCKET TV-R TROUGHPASS 10dB

- TV-R troughpass
- frequency range 5÷862 MHz
- reduction: R-10dB, TV-10dB, trough-2dB
- in accordance with EN 50083-1
- screw contacts



- KQ16PWXO
- KQ16TIXO
- KQ16ATXO

UTIČNICA SAT-TV-R ZAVRŠNA 3dB

- SAT-TV-R završna
- frekvenjski raspon 5÷2400 MHz
- prigušenje: R-1dB, TV-1.5dB, SAT-3dB
- usklađeno s normom EN 50083-1
- vijčano pričvršćivanje

SOCKET SAT-TV-R END-LINE 3dB

- SAT-TV-R end-line
- frequency range 5÷2400 MHz
- reduction: R-1dB, TV-1.5dB, SAT-3dB
- in accordance with EN 50083-1
- screw contacts

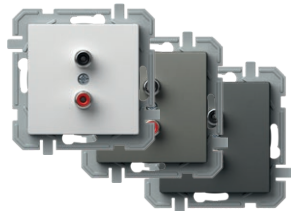

- KQ22PWXO
- KQ22TIXO
- KQ22ATXO

UTIČNICA AUDIO 2xRCA

- audio 2xRCA
- pričvršćivanje vodiča lemljenjem

SOCKET AUDIO 2xRCA

- audio 2xRCA
- soldering connection of cable



- KQ23PWXO
- KQ23TIXO
- KQ23ATXO

UTIČNICA AUDIO ZA ZVUČNIKE

- audio 2x Ø4mm
- za pričvršćivanje vodiča za zvučnike, utikača Ø4mm ili viljuškaste kableske stopice
- pričvršćivanje vodiča lemljenjem sa stražnje strane

SOCKET AUDIO LOUDSPEAKERS

- audio 2x Ø4mm
- to accommodate speaker wire, banana plug Ø4mm or spades
- soldering connection of cable at the back side

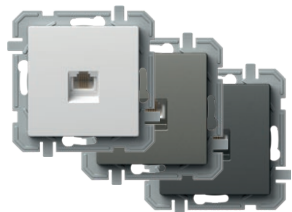

- KQ36PWXO
- KQ36TIXO
- KQ36ATXO

UTIČNICA TEL KS RJ11 6/4

- KS keystone standard pričvršćivanja
- RJ11 6/4
- usklađeno s normom IEC 60603-7

SOCKET TEL KS RJ11 6/4

- KS keystone fixing standard
- RJ11 6/4
- in accordance with IEC 60603-7



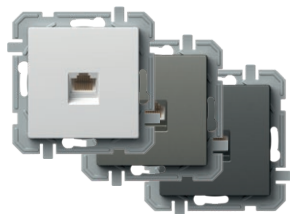

- KQ37PWXO
- KQ37TIXO
- KQ37ATXO

UTIČNICA CAT5e KS RJ45 8/8

- KS keystone standard pričvršćivanja
- CAT5e, RJ45 8/8
- usklađeno s normom IEC 60603-7

SOCKET CAT5e KS RJ45 8/8

- KS keystone fixing standard
- CAT5e, RJ45 8/8
- in accordance with IEC 60603-7

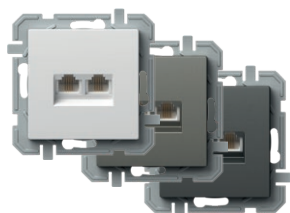

- KQ38PWXO
- KQ38TIXO
- KQ38ATXO

UTIČNICA TEL KS DVOSTRUKA 2x RJ11 6/4

- KS keystone standard pričvršćivanja
- 2x RJ11, 6/4
- usklađeno s normom IEC 60603-7

SOCKET TEL KS DOUBLE 2x RJ11 6/4

- KS keystone fixing standard
- 2x RJ11, 6/4
- in accordance with IEC 60603-7

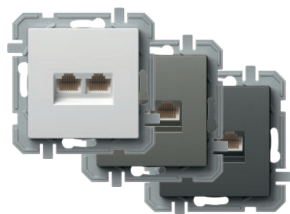

- KQ39PWXO
- KQ39TIXO
- KQ39ATXO

UTIČNICA CAT5e KS DVOSTRUKA 2x RJ45 8/8

- KS keystone standard pričvršćivanja
- 2x CAT5e, RJ45 8/8
- usklađeno s normom IEC 60603-7

SOCKET CAT5e KS DOUBLE 2x RJ45 8/8

- KS keystone fixing standard
- 2x CAT5e, RJ45 8/8
- in accordance with IEC 60603-7

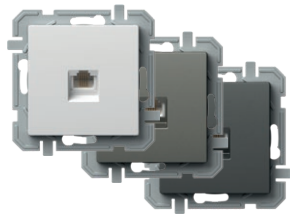

- KQ35PWXO
- KQ35TIXO
- KQ35ATXO

UTIČNICA TEL LT RJ11 6/4

- TEL LT vijak
- vijčano pričvršćivanje vodiča
- RJ11 6/4
- usklađeno s normom IEC 60603-7

SOCKET TEL LT RJ11 6/4

- TEL LT screw
- screw contacts
- RJ11 6/4
- in accordance with IEC 60603-7



- KQ40PWXO
- KQ40TIXO
- KQ40ATXO

UTIČNICA CAT6 KS RJ45 8/8

- KS keystone standard pričvršćivanja
- CAT6, RJ45 8/8
- usklađeno s normom IEC 60603-7

SOCKET CAT6 KS RJ45 8/8

- KS keystone fixing standard
- CAT6, RJ45 8/8
- in accordance with IEC 60603-7



UTIČNICA 2xCAT6 KS RJ45 8/8

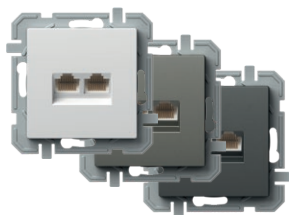

- KQ41PWXO
- KQ41TIXO
- KQ41ATXO

- KS keystone standard pričvršćivanja
 - 2xCAT6, RJ45 8/8
 - usklađeno s normom IEC 60603-7

SOCKET 2xCAT6 KS RJ45 8/8
 - KS keystone fixing standard
 - 2xCAT6, RJ45 8/8
 - in accordance with IEC 60603-7

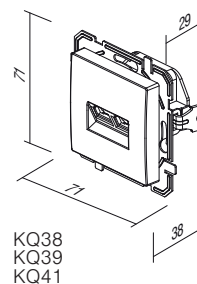
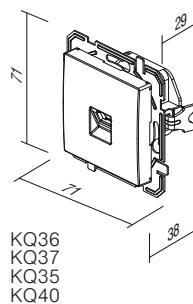
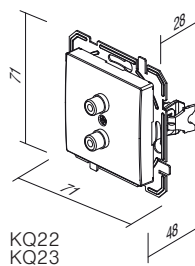
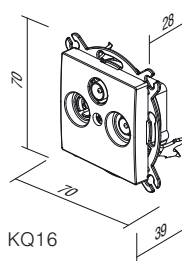
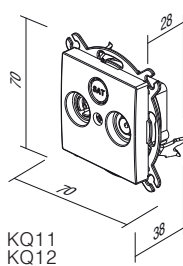
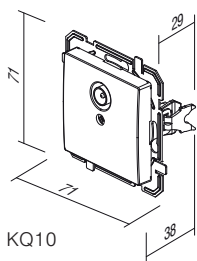

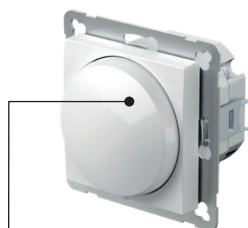

EQ15

PW

XO

tip type	naziv description	tehnički podaci technical data	boja colour	opcijski opis 1 optional data 1
EQ15	ZATAMNJIVAČ ROTACIJSKI IZMJEN DIMMER ROTATIVE 2WAY	RL 400W	<input type="checkbox"/> PW bijela – sjaj polar white	XO bez okvira without cover plate
EQ16	ZATAMNJIVAČ ROTACIJSKI IZMJEN DIMMER ROTATIVE 2WAY	RLC 400W	<input type="checkbox"/> TI titan titanium	
EQ19	ZATAMNJIVAČ ROTACIJSKI IZMJEN DIMMER ROTATIVE 2WAY	LED 100W	<input type="checkbox"/> AT antracit anthracite	
⋮	⋮	⋮		



- EQ15PW
- EQ15TI
- EQ15AT

ZATAMNJIVAČ ROTACIJSKI IZMJEN RL 400W

- rotacijski s izmjeničnom sklopkom
- opterećenje RL, 40W – 400W
- mogućnost povezivanja s izmjeničnom sklopkom
- nije dopušteno povezivanje više zatamnivača
- usklađeno s normama EN 60669-1 i EN 60669-2-1
- bezvijačno pričvršćivanje vodiča 1.5-2.5mm²
- napajanje 230 V[~] 50 Hz
- priložen zamjenjivi osigurač

DIMMER ROTATIVE 2WAY RL 400W

- rotation control with 2-way switch
- load RL, 40W - 400W
- 2-way switch combination is possible
- more dimmers combination is not allowed
- in accordance with EN 60669-1 and EN 60669-2-1
- plug-in contacts 1.5mm²
- supply 230V[~] 50Hz
- replaceable fuse included



ZATAMNIVAČ ROTACIJSKI IZMJEN RLC 400W

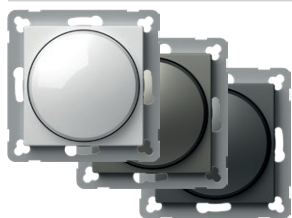

- EQ16PWXO
- EQ16TIXO
- EQ16ATXO

- rotacijski s izmjeničnom sklopkom
- opterećenje RLC, 20W – 400W
- mogućnost povezivanja s izmjeničnom sklopkom
- nije dopušteno povezivanje više zatamnivača
- usklađen s normama EN 60669-1 i EN 60669-2-1
- bezvijčano pričvršćivanje vodiča 1.5mm²
- napajanje 230V~ 50 Hz
- elektronski osigurač

*DIMMER ROTATIVE 2WAY RLC 400W*

- rotation control with 2-way switch
- load RLC, 20W - 400W
- 2-way switch combination is possible
- more dimmers combination is not allowed
- in accordance with EN 60669-1 and EN 60669-2-1
- plug-in contacts 1.5mm²
- supply 230V~ 50Hz
- electronic fuse

ZATAMNIVAČ ROTACIJSKI IZMJEN LED 100W

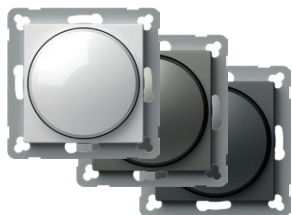

- EQ19PWXO
- EQ19TIXO
- EQ19ATXO

- rotacijski s izmjeničnom sklopkom
- opterećenje: LED, 0-100W (max. 10 LED tinjalica)
GLS, 10-250W
- mogućnost povezivanja s izmjeničnom sklopkom
- nije dopušteno povezivanje više zatamnivača
- usklađeno s normama EN 60669-1 i EN 60669-2-1
- bezvijčano pričvršćivanje vodiča 1.5-2.5mm²
- napajanje 230V~ 50 Hz
- priložen zamjenjivi osigurač

*DIMMER ROTATIVE 2WAY LED 100W*

- rotation control with 2-way switch
- load: LED, 0-100W (max. 10 LEDs)
GLS, 10-250W
- 2-way switch combination is possible
- more dimmers combination is not allowed
- in accordance with EN 60669-1 and EN 60669-2-1
- plug-in contacts 1.5mm²
- supply 230V~ 50Hz
- replaceable fuse included

EQ15, EQ16, EQ19

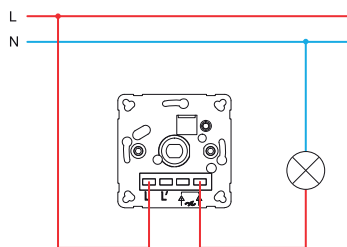

EQ15, EQ16, EQ19

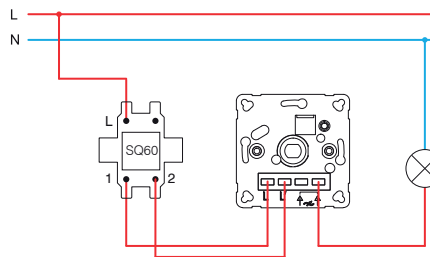

EQ15, EQ16, EQ19

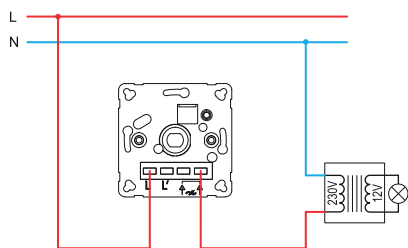

EQ15, EQ16, EQ19

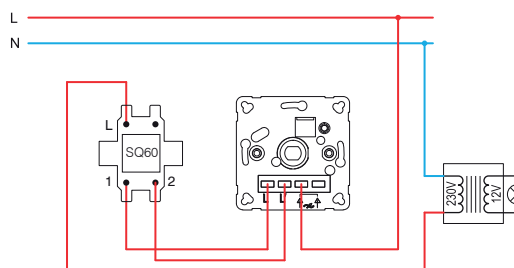

EQ16, EQ19

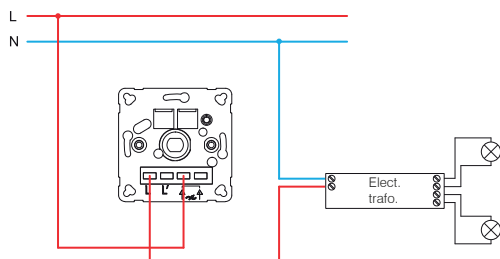

EQ16, EQ19

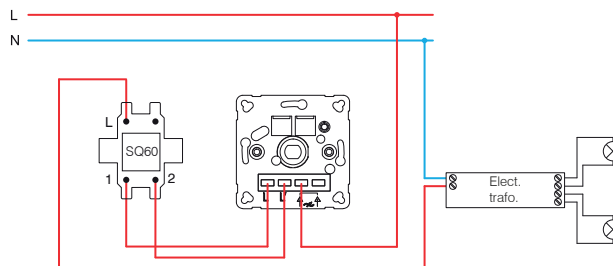

EQ15 (40÷400W)

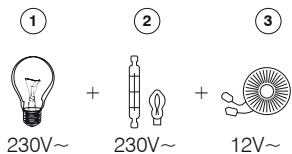

- 1 - žarulja sa žarnom niti / incandescent lamp
- 2 - halogena žarulja / halogen lamp

EQ16 (20÷400W)

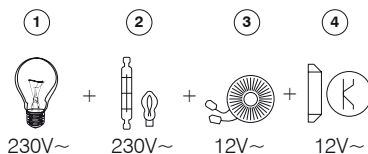

- 3 - klasični transformator / classical transformer
- 4 - elektronički transformator / electronic transformer

EQ19 (GLS 10÷250W ; LED 0÷100W)

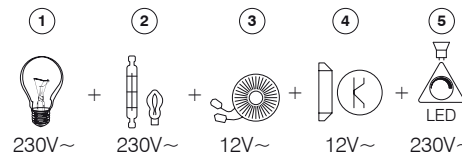

- 5 - LED tinjalica s regulacijom osvjjetljenja / dimmable LED lamp

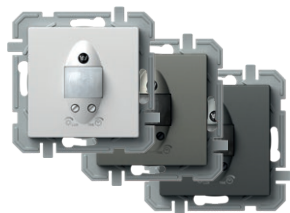

- EQ32PWXO
- EQ32TIXO
- EQ32ATXO

IR SKLOPKA 5A 230V~

- IR infracrvena sklopka
- napajanje: 230V~ ±10 % 50Hz
- relej: 5A / 250V~ izlaz za ograničeni strujni tok s visokim otporom za prolaz kroz ništicu
- razina zaštite: IP40
- presjek žica na kontaktnom terminalu: 0,75 – 2,5 mm²
- kut prepoznavanja: do 110° pri 20°C
- raspon prepoznavanja: približno 8 m pri 20°C
- prilagodljivost vremenskog trajanja: od približno 5 s do 12 min
- prilagodljivost osvjjetljenja: od približno 5 do 200 LUX
- radna temperatura: od 0°C do +40°C
- nije prikladan za ugradnju u doze duboke 45 mm
- samo za unutrašnju uporabu

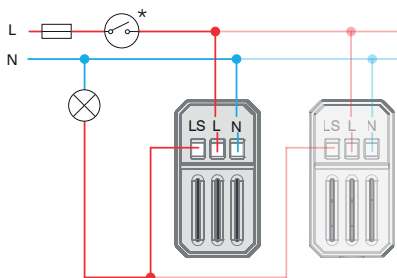

IR SWITCH 5A 230V~

- IR infrared switch
- supply voltage: 230V~ ±10 % 50Hz
- relay: 5A / 250V~ output for limited current with high resistance for zero crossing
- protection rating: IP40
- cross-section of wires at the contact terminal: 0.75 - 2.5 mm²
- detection angle: up to 110° at 20°C
- detection area: approx. 8 m at 20°C
- adjustability of duration: from approx. 5 s to 12 min
- adjustability of brightness: from approx. 5 to 200 LUX
- operating temperature: from 0°C to +40°C
- not suitable for installation in 45 mm deep boxes
- only for indoor usage

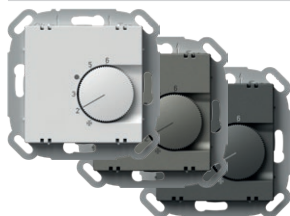

- EQ35PWXO
- EQ35TIXO
- EQ35ATXO

TERMOSTAT GRIJANJE

- načina rada: grijanje
- napajanje: 230 VAC, 50 Hz
- izlaz: 4 A (max. 10 A), 230 VAC, 50 Hz
- izlazni priključak: NC (max. 10 aktuatora)
- raspon regulacije: od +5 °C do +30 °C
- histereza: 0,5 K
- zaštita: IP30
- vrsta senzora: bimetal
- vrsta električnog priključka: opružni kontakti
- vrsta vodiča: 0,75 – 1,5mm² (meka žica) ali 1,0 – 2,5 mm² (tvrda žica)

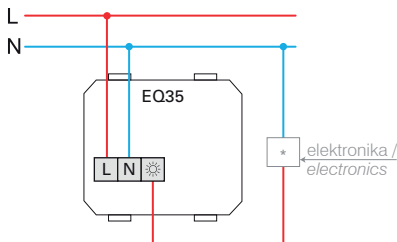

THERMOSTAT HEATING

- operation mode: heating
- power supply: 230 VAC, 50 Hz
- output: 4 A (max. 10 A), 230 VAC, 50 Hz
- switching contact: NC (max. 10 actuators)
- regulation range: +5 °C to +30 °C
- hysteresis: 0,5 K
- protection: IP30
- sensor type: bimetal
- type of electrical connection: spring-loaded contacts
- type of conductors: 0,75 – 1,5mm² (flexible-stranded core) or 1,0 – 2,5 mm² (solid core)

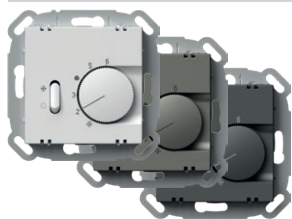

- EQ36PWXO
- EQ36TIXO
- EQ36ATXO

TERMOSTAT GRIJANJE / HLAĐENJE

- načina rada: grijanje / hlađenje
- napajanje: 230 VAC, 50 Hz
- izlaz: 2 A (max. 5 A), 230 VAC, 50 Hz
- izlazni priključak: preklopna sklopka (max. 5 aktuatora)
- raspon regulacije: od +5 °C do +30 °C
- histereza: 0,5 K
- zaštita: IP30
- vrsta senzora: bimetal
- vrsta električnog priključka: opružni kontakti
- vrsta vodiča: 0,75 – 1,5 mm² (meka žica) ili 1,0 – 2,5 mm² (tvrda žica)

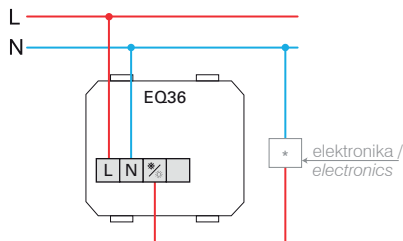

THERMOSTAT HEATING / COOLING

- operation mode: heating / cooling
- power supply: 230 VAC, 50 Hz
- output: 2 A (max. 5 A), 230 VAC, 50 Hz
- switching contact: changeover switch (toggler, max. 5 actuators)
- regulation range: +5 °C to +30 °C
- hysteresis: 0,5 K
- protection: IP30
- sensor type: bimetal
- type of electrical connection: spring-loaded contacts
- type of conductors: 0,75 – 1,5mm² (flexible-stranded core) or 1,0 – 2,5 mm² (solid core)

TERMOSTAT PODNO GRIJANJE

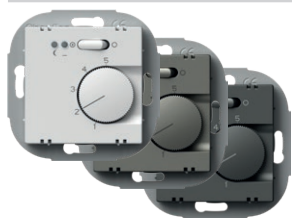

- EQ37PWXO
- EQ37TIXO
- EQ37ATXO

- način rada: podno grijanje
- napajanje: 230 VAC, 50 Hz
- izlaz: 2 A (max. 16 A), 230 VAC, 50 Hz
- raspon regulacije: od +10 °C do +50 °C
- histereza: 1 K
- zaštita: IP30
- vrsta senzora: NTC u skladu s DIN EN 60730-2-1
- indikatori: crvena LED za grijanje i zelena LED za noćni način sa smanjenom funkcionalnošću
- vrsta električnog priključka: vijčani kontakti
- vrsta vodiča: 0,5 – 2,5 mm²

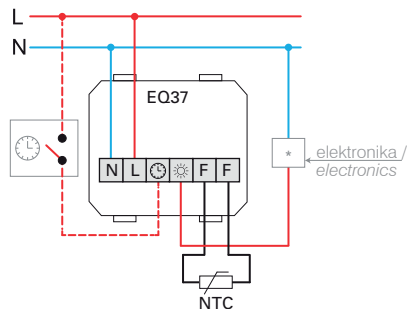

THERMOSTAT FLOOR HEATING

- operation mode: floor heating
- power supply: 230 VAC, 50 Hz
- output: 2 A (max. 16 A), 230 VAC, 50 Hz
- regulation range: +10 °C to +50 °C
- hysteresis: 1 K
- protection: IP30
- sensor type: NTC in compliance with DIN EN 60730-2-1
- indicators: Red LED for heating and green LED for night decrease mode
- type of electrical connection: Screw contacts
- type of conductors: 0,5 – 2,5mm²

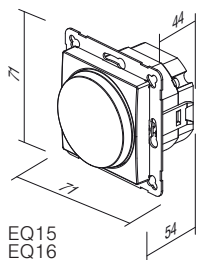

EQ15
EQ16
EQ19

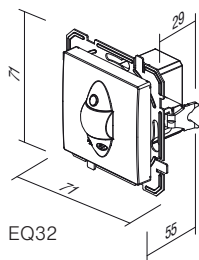

EQ32

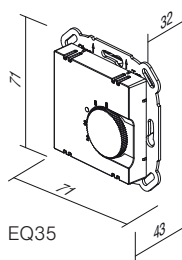

EQ35

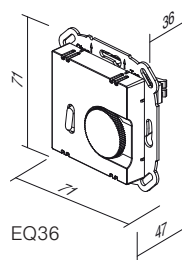

EQ36

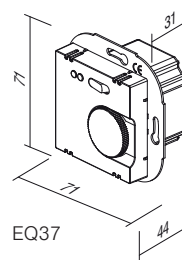

EQ37

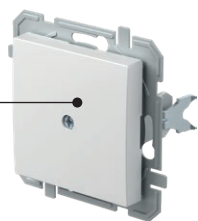

PQ10

PW

XO

tip type	naziv description	boja colour	opcijski opis 1 optional data 1
PQ10	PUNILO BLANK	<input type="checkbox"/> PW bijela – sjaj polar white	XO bez okvira without cover plate
PQ30	POKLOPAC TAE/TDO COVER TAE/TDO	<input type="checkbox"/> TI titan titanium <input type="checkbox"/> AT antracit anthracite	

PUNILO



- PQ10PWXO
- PQ10TIXO
- PQ10ATXO

- za pokrivanje praznih otvora
BLANK
- for filling up empty spaces



POKLOPAC TAE/TDO

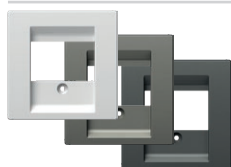

- PQ30PW
- PQ30TI
- PQ30AT

- TAE ili TDO poklopac s vijkom
COVER TAE/TDO
- TAE or TDO cover with screw

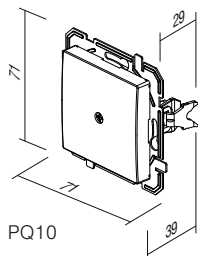

PQ10

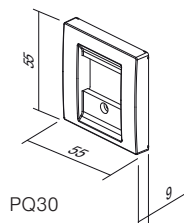

PQ30



OQ10

PW

tip type	naziv description	boja colour
OQ10	OKVIR LOGIQ 1 COVER PLATE LOGIQ 1	PW bijela – sjaj polar white
OQ20	OKVIR LOGIQ 2 COVER PLATE LOGIQ 2	TI titan titanium
OQ30	OKVIR LOGIQ 3 COVER PLATE LOGIQ 3	AT antracit anthracite
:	:	
:	:	



- OQ10PW
- OQ10TI
- OQ10AT

OKVIR LOGIQ 1

- dekorativni pojedinačni okvir
- usklađeno s normom EN 60669-1

COVER PLATE LOGIQ 1

- decorative cover plate 1-gang
- in accordance with EN 60669-1

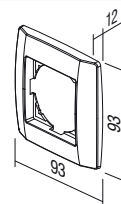

- OQ20PW
- OQ20TI
- OQ20AT

OKVIR LOGIQ 2

- dekorativni dvostruki okvir
- u skladu s EN 60669-1

COVER PLATE LOGIQ 2

- decorative cover plate 2-gang
- in accordance with EN 60669-1

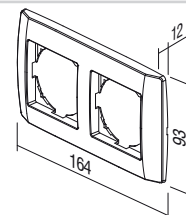



- QQ30PW
- QQ30TI
- QQ30AT

OKVIR LOGIQ 3

- dekorativni trostruki okvir
- u skladu s EN 60669-1

COVER PLATE LOGIQ 3

- decorative cover plate 3-gang
- in accordance with EN 60669-1

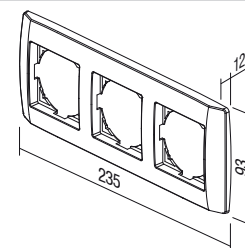

- QQ40PW
- QQ40TI
- QQ40AT

OKVIR LOGIQ 4

- dekorativni četverostruki okvir
- u skladu s EN 60669-1

COVER PLATE LOGIQ 4

- decorative cover plate 4-gang
- in accordance with EN 60669-1

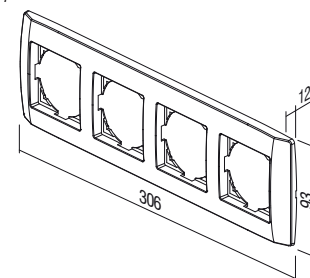

- QQ50PW
- QQ50TI
- QQ50AT

OKVIR LOGIQ 5

- dekorativni peterostruki okvir
- u skladu s EN 60669-1

COVER PLATE LOGIQ 5

- decorative cover plate 5-gang
- in accordance with EN 60669-1

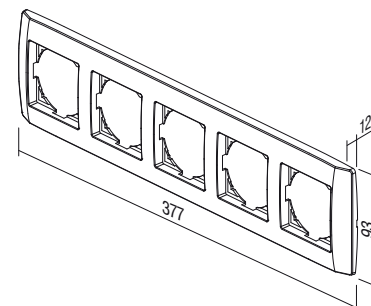

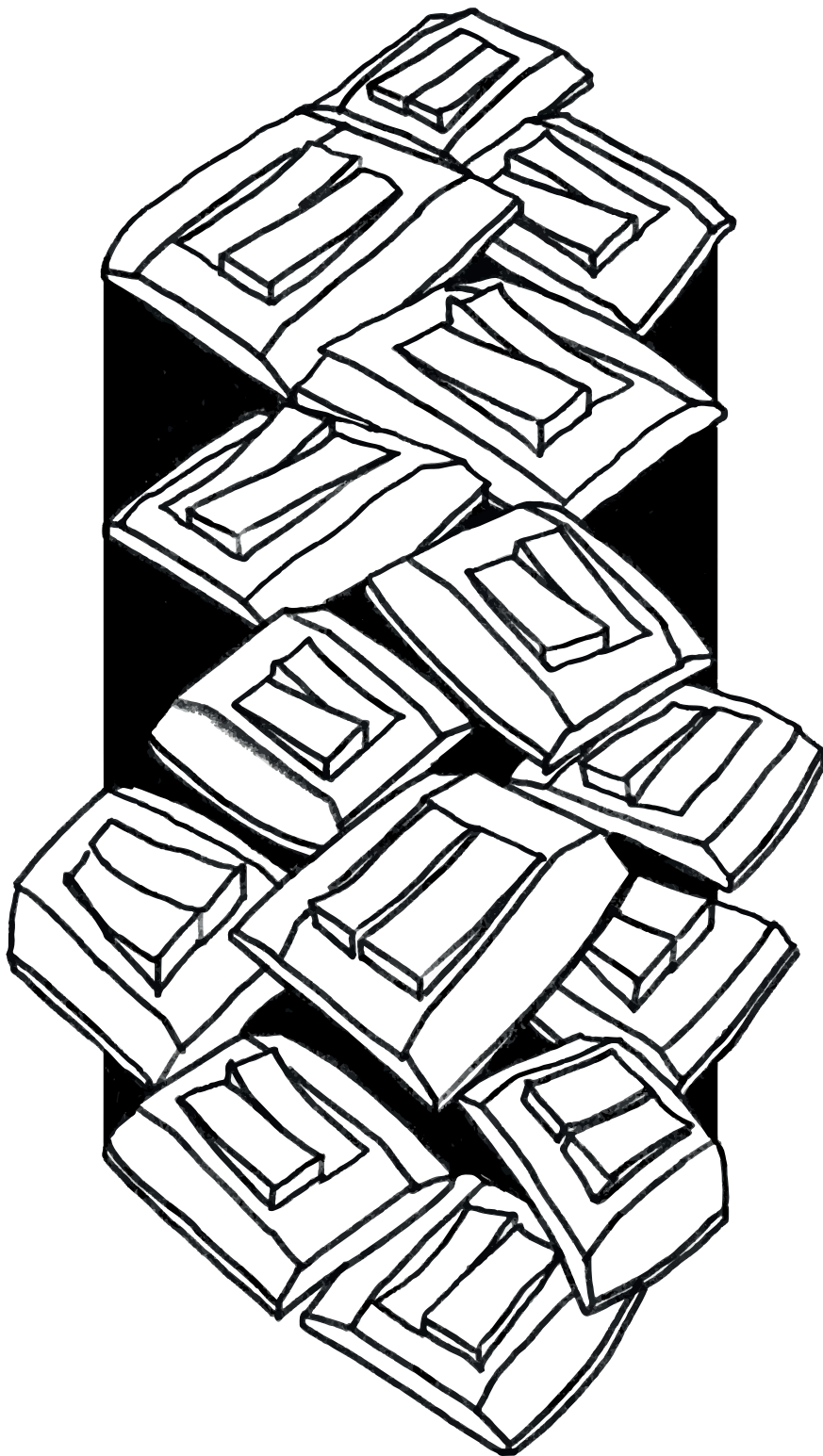

TEM

TEM Čatež d.o.o.
Čatež 13, 8212 Velika Loka
Slovenija
e: info@tem.si
w: www.tem.si
t: +386 (0)7 348 99 00

WJ1220JVE-T (18430)
katalog 2020, 1. izdanje, 04/2020

TEM
WWW.TEM.SI
JVE 2020