

TEM 2020

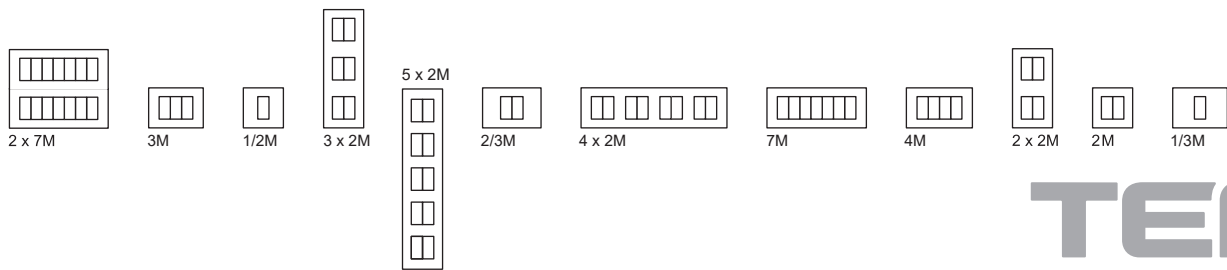

On | Off and everything in between





TEM

Mirë se vini në familje **MODUL**

Welcome to the **MODUL** family

Ne po zgjerojmë dhe perfeksionojmë familjen e çelësave Modul për të gjitha llojet e dhomave.

We are expanding and perfecting the modern Modul switch family for all types of rooms.



discovering new insights

zbulojmë ide të reja

MODUL

Linjat e dizajnit Pure, Line dhe Soft reflektojnë një stil jetese, modern, të sofistikuar dhe të pavarur. Ju mund të zgjidhni nga një gamë e gjerë dhe e pasur ngjyrash, motivesh dhe prizash që i përshtaten atmosferës së dëshiruar.

The Pure, Line and Soft design lines reflect a modern, sophisticated and independent lifestyle. You can choose from a wide and rich selection of colours, patterns and shapes to alter the appearance of your switches and sockets so that they fit the desired atmosphere and mood.

PURE

materiale natyrale
natural materials

dru wood
metal metal
xham glass

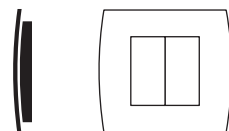

—line—

—soft—



linja të drejta
straight lines



linja të buta
soft lines

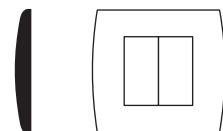
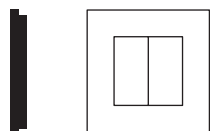

PURE



jetë e mrekullueshme wonderful living

Nga pastërtia e një bote të sapolindur vjen historia e linjës Pure. Prekja e motiveve natyrale ndërthuret me një shije të sofistikuar për linjat dhe format me fije të teknologjisë së fjalës së fundit.

From the cleanliness and purity of a new-born world stems the story of the Pure line. The touch of natural motifs is intertwined with a sophisticated taste for lines and form and interwoven with threads of state-of-the-art technology.



PURE

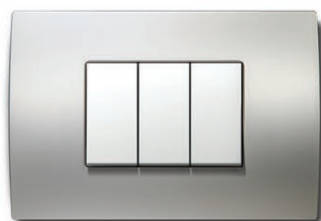
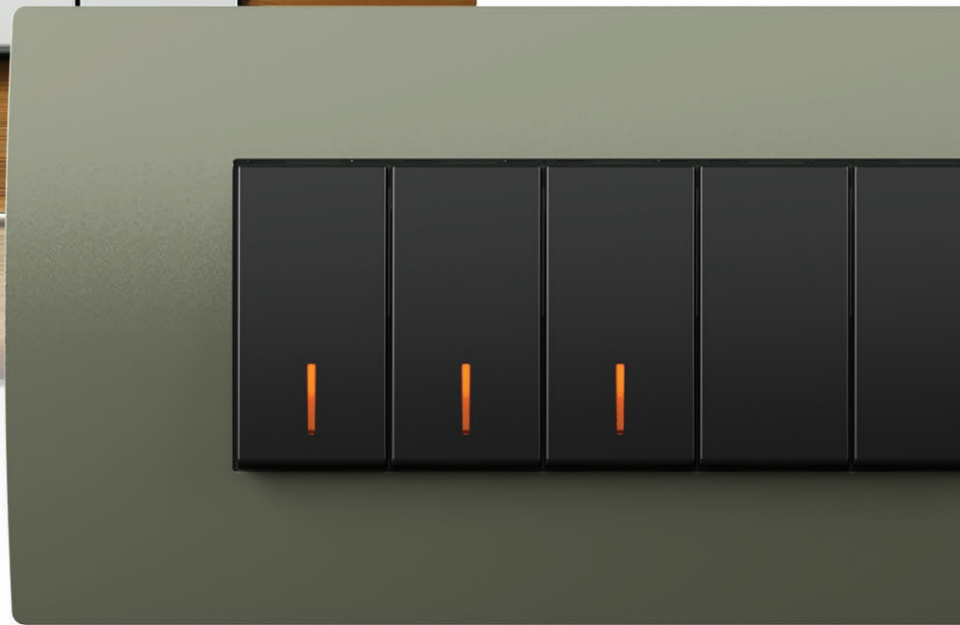



ndjesia e natyrës feeling of nature

Linja e çelësave Pure dallohet nga materialet natyrale: metal, dru dhe xham. Dizajni i vet unik i jep asaj një ngjyrim special. Është mbresëlënëse, por nuk ju pengon. Rrezaton sensualitet, sofistikim, standard të lartë dhe, sigurisht, pastërti.

The Pure switch line is distinguished by its natural materials: metal, wood and glass. Its unique design gives it a special touch. It is striking yet unobtrusive. It radiates sensuality, sophistication, high standards and, of course, cleanliness.

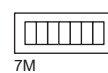
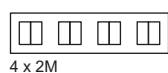

line



harmonia e linjave të drejta

harmony of straight lines

Përgatituni për perfeksionin elegant të formave të drejta. Provoni sipërfaqe brilante që luajnë me delikatesë me elementet moderne të dhomës suaj. Ne kemi përfshirë teknologjinë “Soft Touch” posaçërisht për ju, duke e kthyer çdo prekje në një përvojë unike.

Prepare for the elegant perfection of straight shapes. Try brilliant surfaces that gently play with modern elements of your room. We have incorporated “Soft Touch” technology especially for you, turning every touch into a unique experience.



line

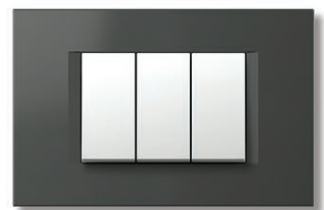
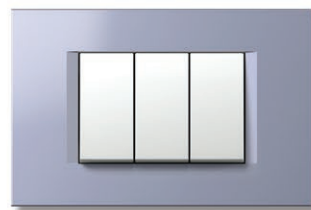
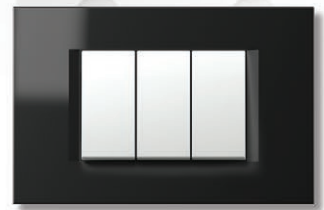
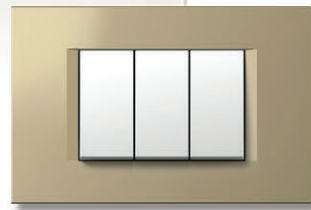
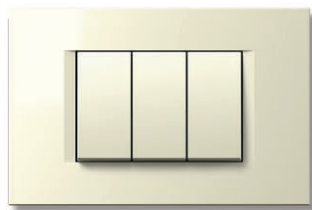
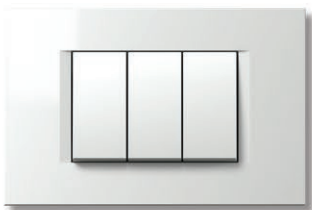



dizajn modern modern design

Linjat e tij të drejta dhe të buta krijojnë një dizajn klasik.
Profili i tij i drejtë perfekt dhe elegant dhe veçoritë ergonomike me prekje të butë i japin një pamje elegante dhe të mrekullueshme nga të gjitha këndet.

Its straight, smooth lines make for a timeless design.
Its perfectly straight, sleek profile and soft-touch ergonomics give it an amazingly elegant appearance from all angles.

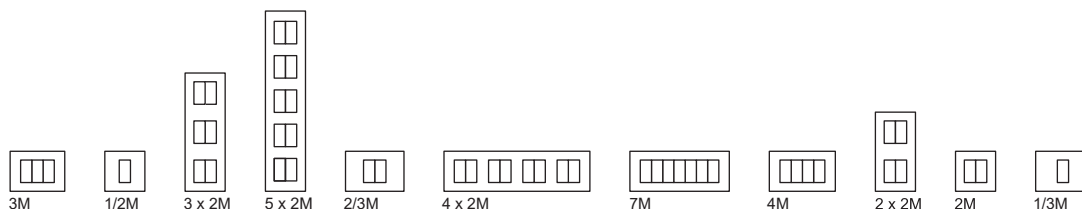

soft



butësi në shtëpinë tuaj

softness in your home

Lejoni format e rumbullakëta dhe pjesët bashkuese të buta të sjellin butësi në shtëpinë tuaj.

Let the rounded shapes and soft transitions bring softness into your home.



soft

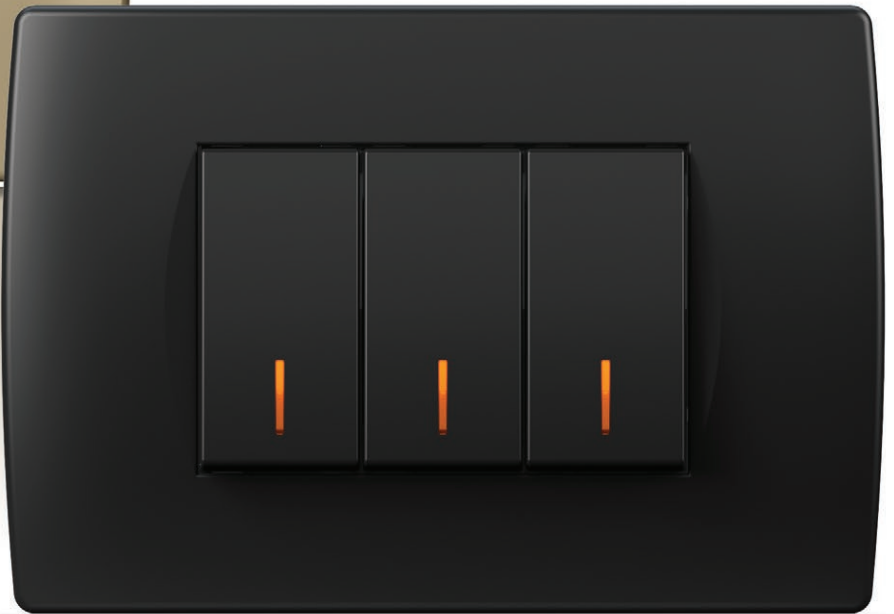



një shtëpi e ngrohtë a warm home

Forma të buta të rrumbullakosura në mënyrë perfekte me një përzgjedhje të bukur ngjyrash dhe shtresash speciale për një ngjyrim special.

Perfectly soft shapes rounded off by a subtle selection of colours and special coatings for a special touch.

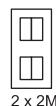
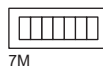
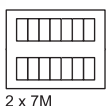



antracit

anthracite

Gamës sonë i shtojmë dy përvoja me ngjyra – ANTRACIT dhe TITAN. Të dyja plotësojnë sensin e sofistikuar të klientëve tanë për stil dhe plotësim të detajeve të hapësirave sipas dëshirave të tyre. Tani mund ta përditësoni apartamentin tuaj modern në harmoni.

We are adding two colour experiences to our range – ANTHRACITE and TITANIUM. They both satisfy our customer's sophisticated sense of style and complement the details of spaces according to their wishes. Now you can upgrade your modern apartment in harmony.

ngjyrat në tendencë

trendy colours

19



titan
titanium

multi-funksionalitet

multifunctionality



estetikë

aesthetics

Ne kemi krijuar kapakë mbulues të mëdhenj që ju lejojnë të menaxhoni shumë funksione nga një pikë e vetme. Ato janë të disponueshme në gamat e dizajnit LINE, SOFT dhe PURE. Kapakët mbulues, që janë prej materialesh natyrale, përdorin përsëritjen e elementeve të dizajnit për t'i çuar në një nivel të lartë estetik.

We have created larger cover plates for you that allow you to manage multiple functions from one spot. They are available in the LINE, SOFT and PURE design ranges. The cover plates, which are made from natural materials, utilise the repetition of design elements to elevate them to a high aesthetic level.



reostat universal

universal dimmer

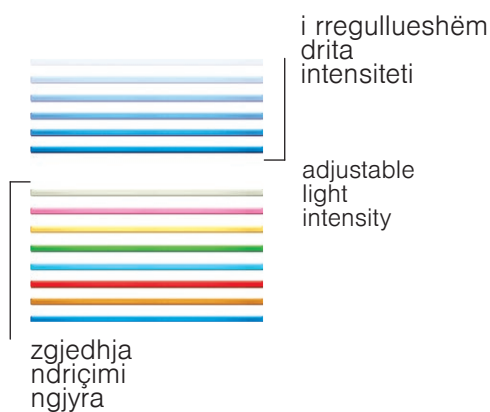

choosing
illumination
colour

Në errësirë Touch bëhet një dritë e butë ambienti. Ajo shënon pikën e çelësit dhe e ndriçon me delikatesë vendin. Ju mund të zgjidhni mes tetë ngjyrave të ndryshme të një drite të butë dhe të rregulloni ndriçimin sipas dëshirës suaj.

In the dark Touch becomes a tender soft ambient light. It marks the spot of a switch and gently illuminates a place. You can choose among eight different colours of tender light and adapt its brightness according to your mood.

TOUCH®

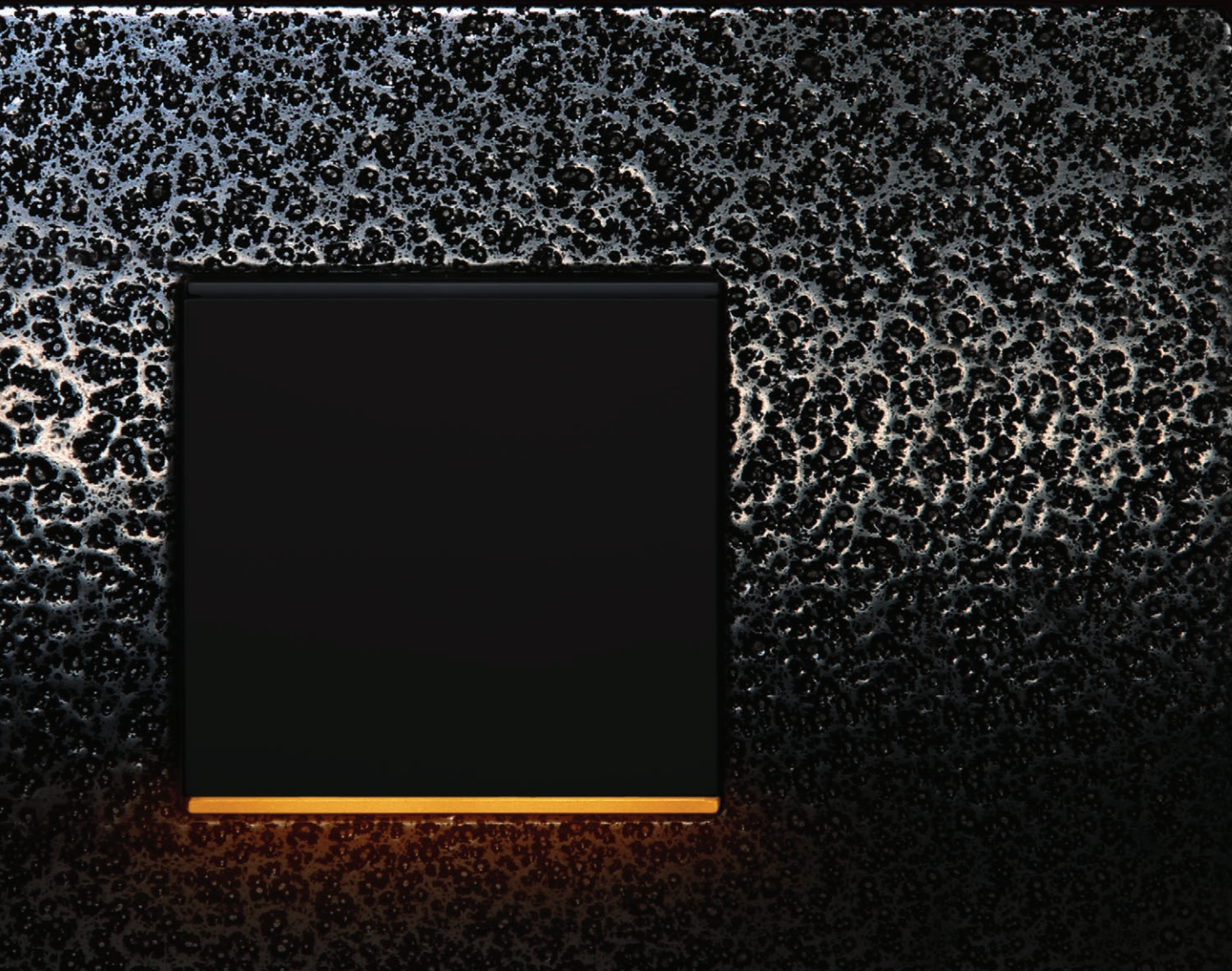

drita siç nuk është parë asnjëherë më parë light as never seen before

Një dritë e ulur me reostat krijon një atmosferë të qetë, sensuale dhe romantike. Është karakteristika e vendeve romantike dhe e orëve të vona të mbrëmjes në shtëpi ose në punë. Ndezja është e butë dhe e zgjatur. Jo vetëm që kjo zgjat jetëgjatësinë e llambës, por e kthen gjithashtu errësirën në dritë në një mënyrë më të ngadaltë dhe shumë më të këndshme. Touch ju mundëson të ulni dritën kudo, pavarësisht llojit të llambave.

A dimmed light makes peaceful, sensual and romantic atmosphere. It is a trade mark of romantic places and quiet late evening hours spent at home or at work. Switching is soft and extended. It does not only prolong the lamp life expectancy, but also changes darkness into light in a slower and much more pleasant way. Touch enables you to dim the light anywhere, regardless of the type of lamps.





të gjitha në një vend

everything in one place

Shtëpia juaj është qendra e jetës suaj. Shumëllojshmëria e pajisjeve që përdorni kërkon një numër konektorësh dhe prizash. Krijoni qendrën tuaj multimediale që do t'ju lejojë të lidhni dhe të përdorni një numër të shumtë komponentësh të ndryshëm në një vend.

Your house is the centre of your life. The multitude of devices you use requires a number of connectors and sockets. Create your own multimedia centre, one that will allow you to connect and use a multiple number of different components in one place.



kontrolluesi inovativ i temperaturës

innovative temperature controller

Akomodohuni duke kontrolluar temperaturën në dhomën tuaj të ndenjes dhe të punës gjatë të gjitha sezoneve me një termostat inteligjent. Ju lejon të kontrolloni pajisjet e ngrohjes dhe të ftohjes dhe përmban një funksion Eco.a

Make yourself comfortable by controlling the temperature in your living and working rooms during all seasons with a smart thermostat. It allows you to control heating and cooling devices and features an eco-function.

komoditet në dhomën tuaj

comfort in your room



lehtësi përdorimi

convenience of use



TOUCHLESS-pa prekje

Çelësi Touchless ju lejon të shijoni një stil modern jetese, duke mundësuar ndezjen dhe fikjen e dritave, pa qenë nevoja për prekje fizike. Ky opsion është shumë i dobishëm kur i keni duart plot ose të ndotura, sepse mund të arrini ndriçimin e dëshiruar pa qenë nevoja të lodheni.

The touchless switch allows you to enjoy a modern lifestyle, enabling the turning on and off of your lights, without the need for physical interaction. This option is very useful when you find yourself with your hands full, or dirty, as you can achieve the desired lighting without undue fuss.



ndriçim modern

modern illumination





Ilambë 3D

3D lamp

Ritmi i shpejtë i jetës nënkupton se ju bombardoheni vazhdimisht me një mori informacionesh. Llamba me ngjyra 3D ofron një zgjidhje elegante për tabela informuese dhe orientuese. Ju mund të krijoni grafika sipas dëshirave tuaja.

The rapid pace of life means you are constantly being bombarded with a plenty of information. 3D colour lamp provide an elegant solution for information and direction signs. We can make graphics according to your wishes.



BIOPASS – shkyçja pa çelës dere

BIOPASS – keyless unlocking

BIOPASS është gjenerata e re e çelësave për shkyçje pa çelës dere. Ajo kombinon teknologjinë e përparuar të njohjes së gjurmëve të gishtave me hapjen e shpejtë të derës së jashtme.

Thjesht vendosni gishtin mbi çelësin Biopass dhe dyert e shtëpisë apo të zyrës do të hapen. Është shumë e lehtë të përdoret dhe jashtëzakonisht e sigurt. Mund ta menaxhoni pa u lodhur përmes aplikacionit për celular.

BIOPASS is the new generation of switches for keyless unlocking. It combines advanced fingerprint recognition technology with quick front door opening.

Simply put your finger on the Biopass switch and the doors to your home or office will open. It is so easy to use and incredibly secure. You can manage it effortlessly via the mobile app.

siguri e përmirësuar

improved security



individualizëm

individuality



bëjeni tuajën

make it your own

Jini ndryshe. Bëni një çelës sipas shijes suaj. Ju mund të zgjidhni mes ngjyrave të ndryshme të kornizave dhe ne mund t'i zbukurojmë për ju me grafika apo shenja të personalizuar. Zgjidhni një ngjyrë ndriçimi që i përshtatet atmosferës së dhomës suaj.

Be different. Make a switch according to your taste. You can choose between different frame colours and we can decorate them for you with custom graphics or signs. Choose a illumination colour that suits the ambience of your room.



e përshtatshme për përdorim publik
suitable for public use



cilësi dhe qëndrueshmëri quality and durability

Materialet cilësore dhe rezistente sigurojnë jetëgjatësi të çelësave dhe prizave modulare MODUL. Sistemi është i përshtatshëm për montimin dhe përdorimin e lehtë në ambiente publike, ambiente biznesi, akomodime turistike, qendra tregtare, shkolla dhe ambiente sportive. Ai përshtatet në mënyrë të përkryer si në enterierët modernë ashtu edhe në ato klasikë.

Quality and durable materials ensure the long lifetime of the MODUL modular switches and sockets. The system is suitable for mounting and carefree use in public facilities, business premises, tourist accommodation, shopping centres, schools and sports facilities. It fits perfectly in both modern architecture and classical interiors.





karikues të fuqishëm USB

powerful USB chargers

Karikuesit e fuqishëm Modul USB mundësojnë karikim të shpejtë dhe të thjeshtë të smartfonëve, tabletëve dhe pajisjeve tuaja të tjera elektronike përmes një lidhjeje standarde me USB. Ata disponohen në madhësi 1M dhe 2M dhe janë të përkryer për përdorim në dhoma private dhe publike.

The powerful Modul USB chargers enable the fast and simple charging of your smartphones, tablets and other electronic devices via a standard USB connection. They are available in 1M and 2M sizes and are perfect for use in private and public rooms.

karikim i shpejtë

fast charging



një mjedis i sigurt pune

a modern working environment





kanalina estetike prej alumini aesthetic aluminium trunkings

Organizoni hapësirën tuaj në zyrë, shkollë dhe punë. Harroni kabllo të dukshme dhe zgjatuesit jopraktikë. Kanalinet elegante dhe moderne prej alumini ofrojnë hapësirë të mjaftueshme për instalimet elektrike. Çelësat, prizat dhe elementet e komunikimit janë lehtësisht të aksesueshme dhe të disponueshme në vendin e duhur për t'u përdorur. Ato mund të përshtaten ose përditësohen lehtësisht. Krijoni një mjedis të këndshëm dhe funksional për veten.

Organise your office, school and work areas. Forget visible cables and unpractical extensions. The elegant and modern aluminium trunkings offer plenty of space for electrical installations. Switches, sockets and communication elements are easily accessible and available in the right place to be used. They can be easily adapted or upgraded. Arrange a pleasant and functional environment for yourself.

modulariteti

modularity

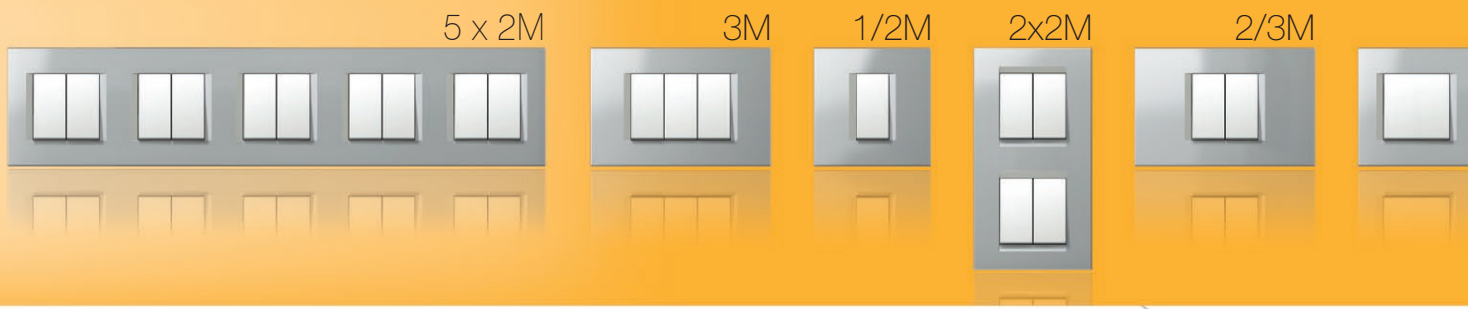

Ne kemi dizajnuar një sistem gjithëpërfshirës që përmban një shumëllojshmëri elementesh, që ju lejojnë çdo konfigurim që dëshironi. Elementet bazë të sistemit janë modulare dhe mund të kombinohen horizontalisht ose vertikalisht.

We have designed a comprehensive system that features a variety of elements, allowing you to create any configuration you wish. The basic elements of the system are modular and can be combined horizontally or vertically.



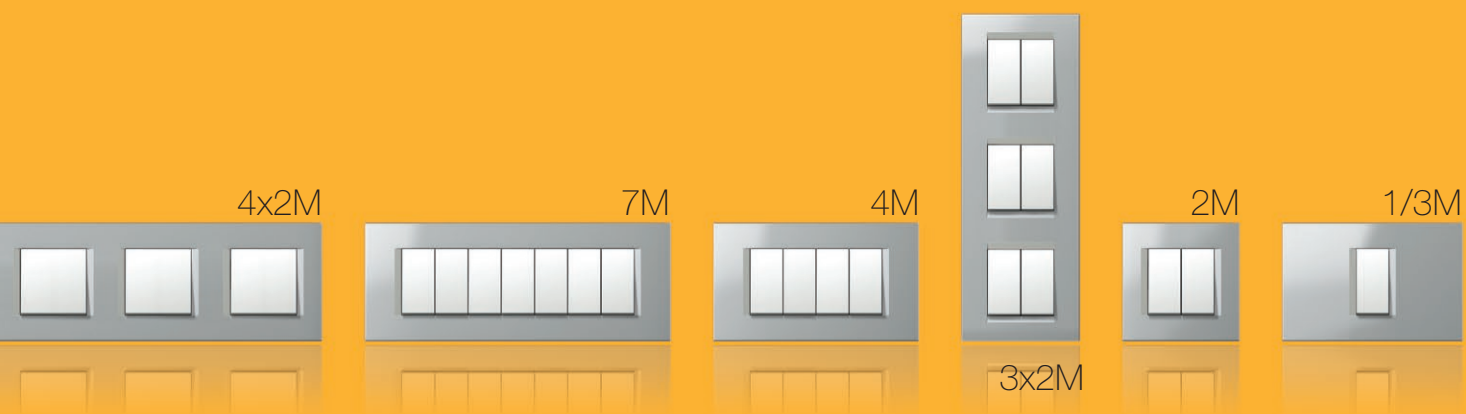

$$1M = \text{[rectangle]}$$

$$2M = \text{[rectangle]} \text{ [rectangle]} = \text{[square]}$$

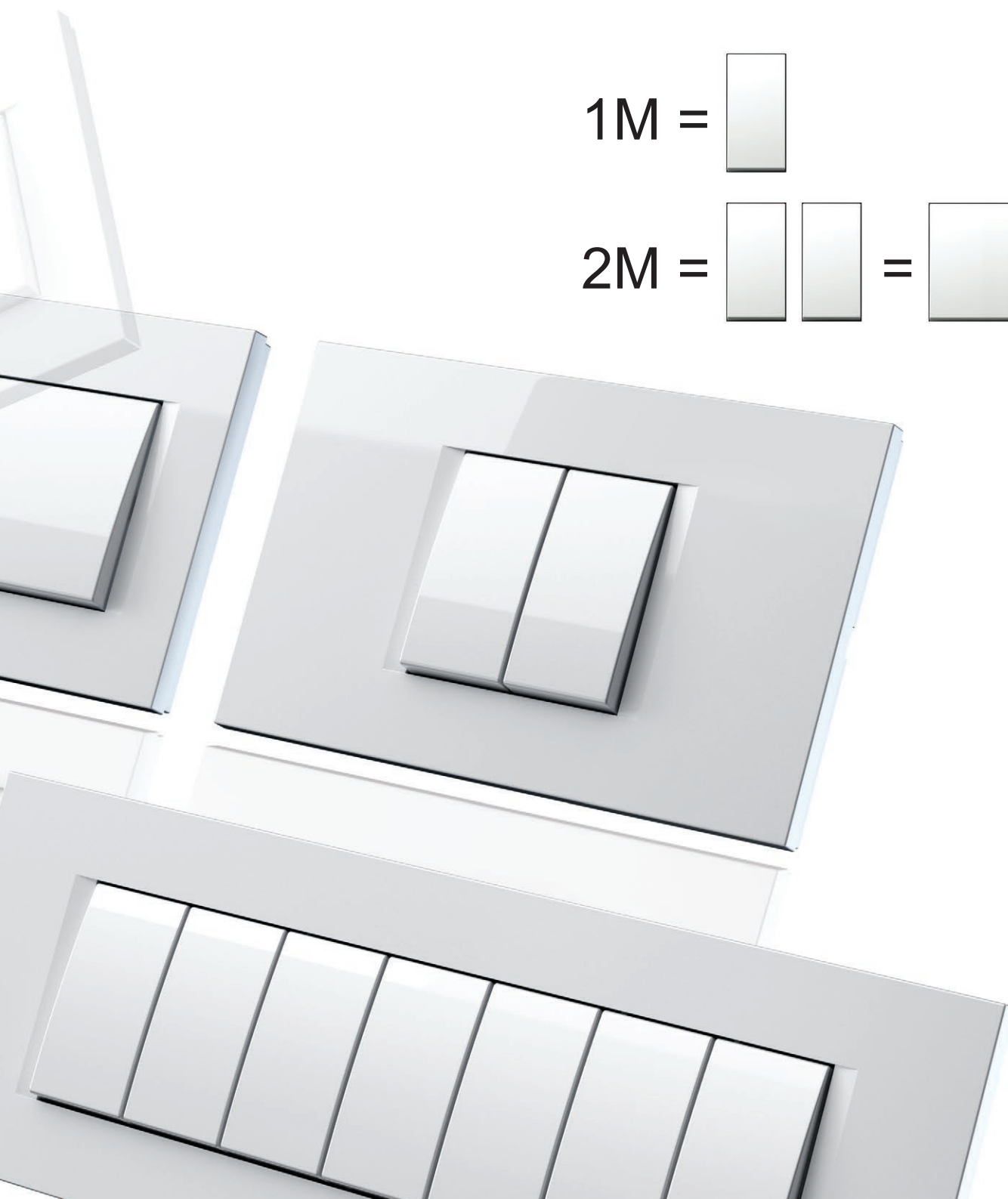

universaliteti

universality

Sistemi ka një përzgjedhje elementesh dhe është i lehtë për t'u instaluar. Setet e çelësve mund të pozicionohen në shumë mënyra të ndryshme, pavarësisht faktit nëse kutia është e rrumbullakët ose drejtkëndore, lidhje individuale ose në seri.

The system features a comprehensive selection of elements and is easy to install. Switch sets can be positioned in many different ways, regardless of whether the box is round or rectangular, individual or serial.

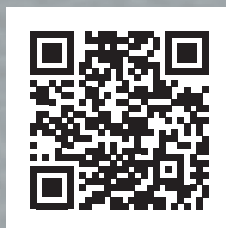

modulmanager.tem.si

Provoni mjetin “ModulManager”, që do t’ju ndihmojë të krijoni çdo kombinim që dëshironi.

Try out the “ModulManager” tool, which will help you put together any combination you want.

zgjidhje për 4 çelësa

solutions for 4 switches



MODUL MANAGER

e lehtë dhe e shpejtë / easy and fast

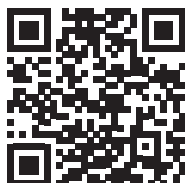



konfiguruesi i çelësave dhe prizave configurator of switches and sockets

Modul Manager ju lejon të kryeni një inventar të plotë dhe të shpejtë të çelësave në ndërtesë ose nga komoditeti i shtëpisë suaj. Ne kemi përgatitur një metodë unike porositjeje, që është praktike dhe e shpejtë. Ju mund të zgjidhni ngjyrat e çelësave, si edhe formën e kornizave, që do të thotë se mund t'i përshtatni ato me hapësirën tuaj ose me kërkesat e klientit. Pse të mos na provoni? Mjafton të keni një smartfon, tablet ose kompjuter dhe <http://modulmanager.tem.si>.

The Modul Manager allows you to perform a complete and quick inventory of switches from the building site itself or from the comfort of your own home. We have prepared a unique ordering method, which is both practical and quick. You can select the colours of the switches, as well as the shape of the frames, meaning you can tailor them to your space or the client's demands. Why not try us out? All you need is a smartphone, a tablet, or a computer and <http://modulmanager.tem.si>.

funksionaliteti

functionality

Modul është zhvilluar për ata që vlerësojnë një produkt që ka dizajn të menduar mirë. Sistemi zë më pak hapësirë, sepse çdo kombinim i elementeve të funksionit mund të futet brenda të njëjtit kapak mbulues. Është e përshtatshme për ndërtesat e reja, si edhe për ato të rikonstruara.

The Modul was developed for those who can appreciate a thoughtfully designed product. The system takes up less space, as any combination of function elements can be fitted inside the same cover plate. It is suitable for new, as well as renovated buildings.



Disponohet edhe Modul Soft në një zgjidhje antibakteriale AW.

The Modul Soft is also available in an antibacterial solution AW.

kapakë mbulues dekorativë
decorative cover plates

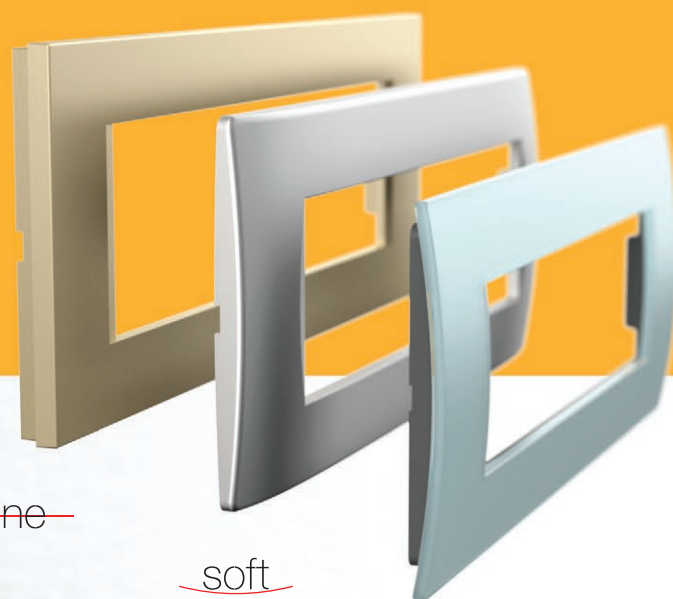

—line—

—soft—

PURE



elemente funksioni
function elements



thjeshtësi simplicity

Elementet e funksionit futen lehtë brenda kornizës së montimit. Zgjidhja “klik-in, klik-out” që kemi zhvilluar për ju do t’ju reduktojë kohën e instalimit. Kontaktet e lidhjes arrihen lehtë nga përpara.

The function elements are easily fitted inside the mounting frame. The “klik-in, klik-out” solution we have developed for you will reduce installation time. The connection contacts are easily accessible from the front.

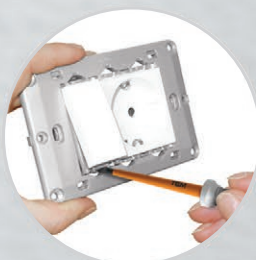
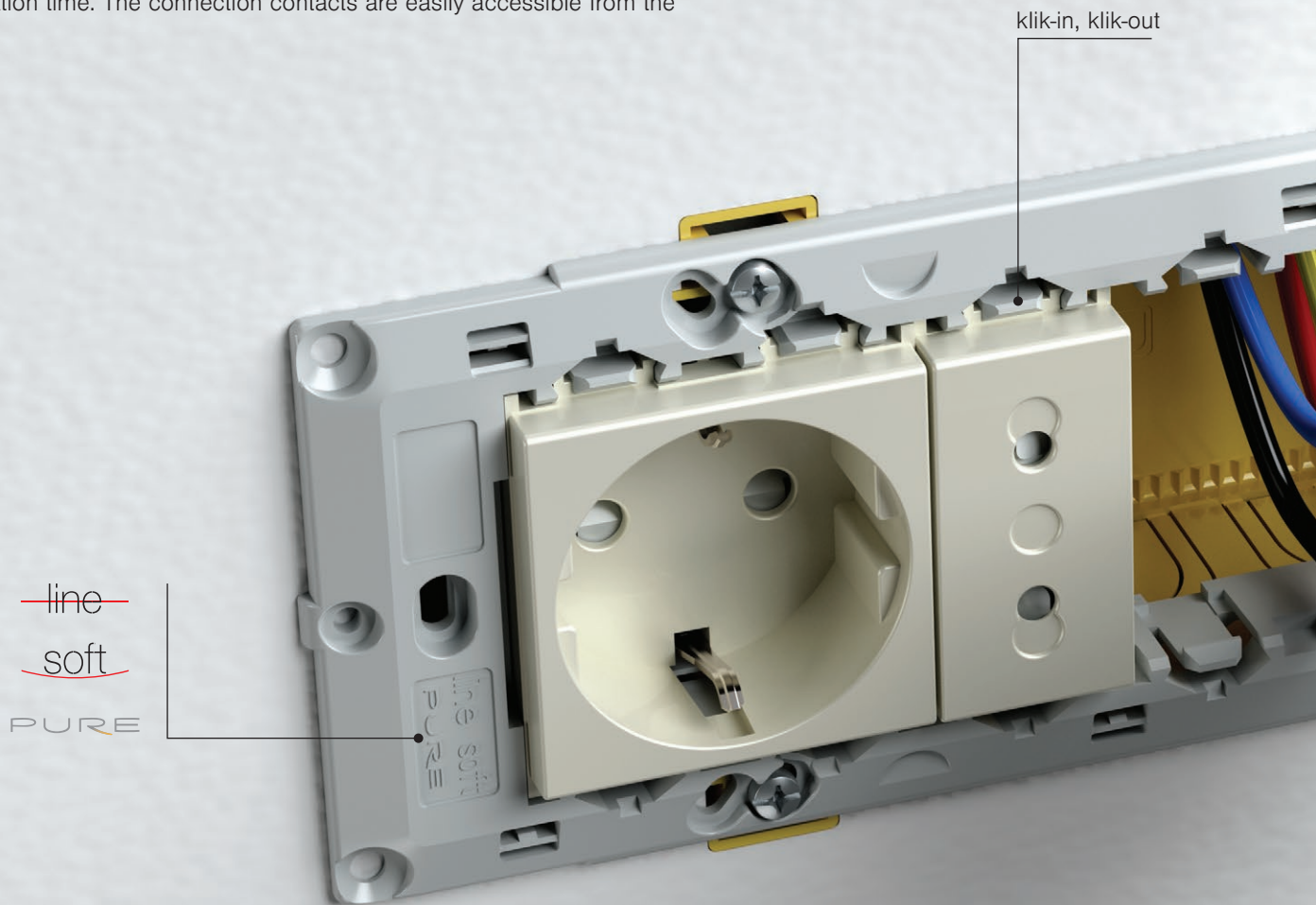

“klik-out” - e thjeshtë dhe e shpejtë, nuk nevojiten vida.

“klik-out” - simple and quick, no screws necessary.

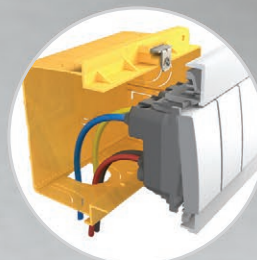

Kutitë drejtkëndore kanë më shumë hapësirë për telat e lidhjes.

Rectangular boxes have more space for connection wires.

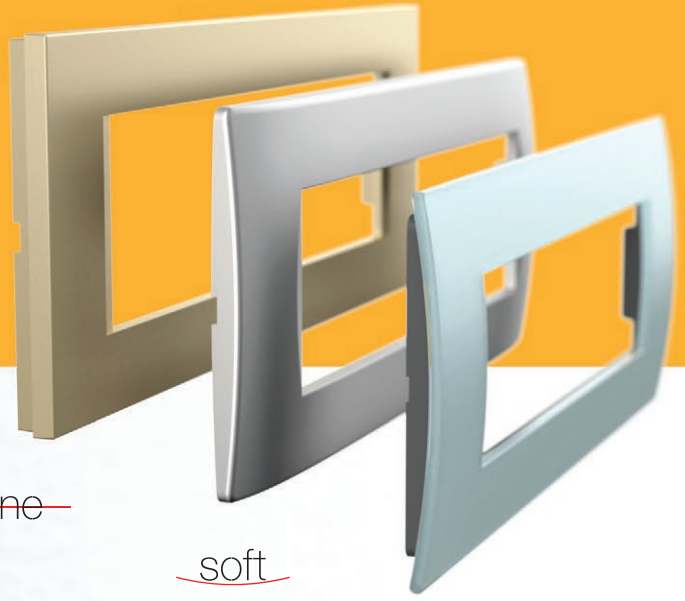
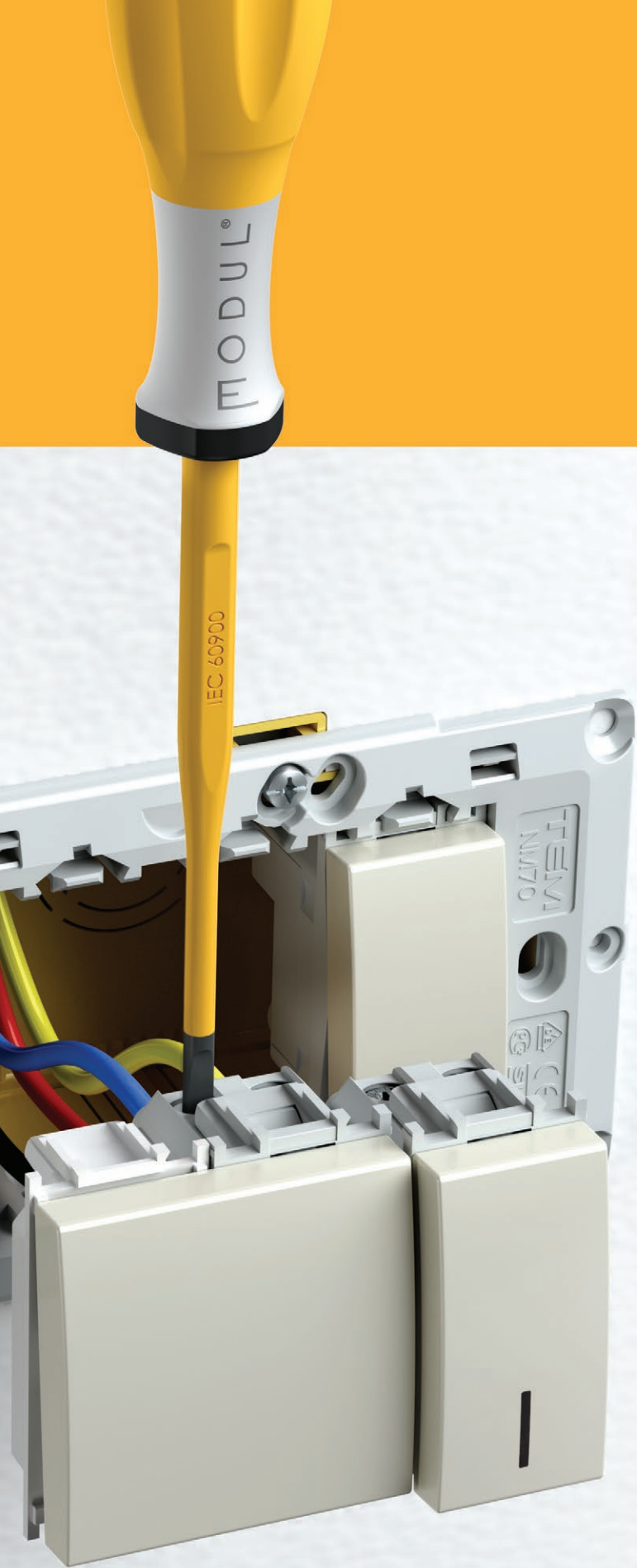

~~line~~

soft

PURE

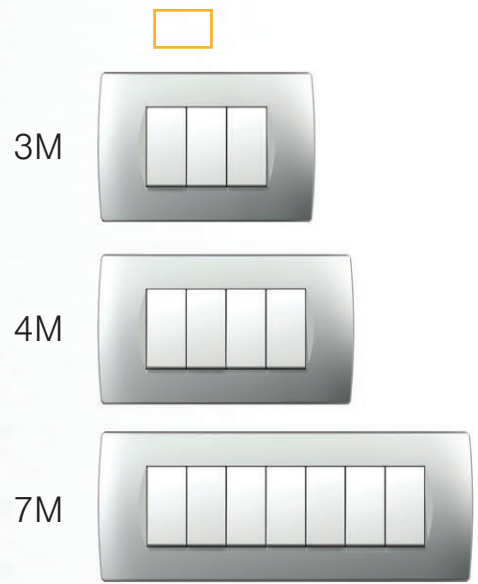

3M

4M

7M

kombinueshmëria

combinability

Modul jep mundësi të shumta edhe me kutitë drejtkëndore. Ju mund t'i kombinoni horizontalisht ose vertikalisht, individualisht ose në grupe. Korniza metalike e montimit siguron qëndrueshmëri të shkëlqyer edhe me përdorim të shpeshtë dhe është e përshtatshme për çdo kapak mbulues dekorativ.

The Modul enables a many possibilities even with round boxes. You can combine them horizontally or vertically, individually or in groups. The metal mounting frame ensures excellent stability even with rough use and is suitable for any decorative cover plates.

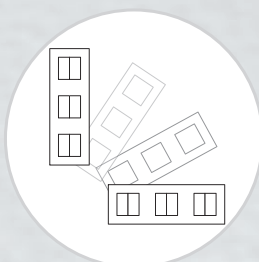
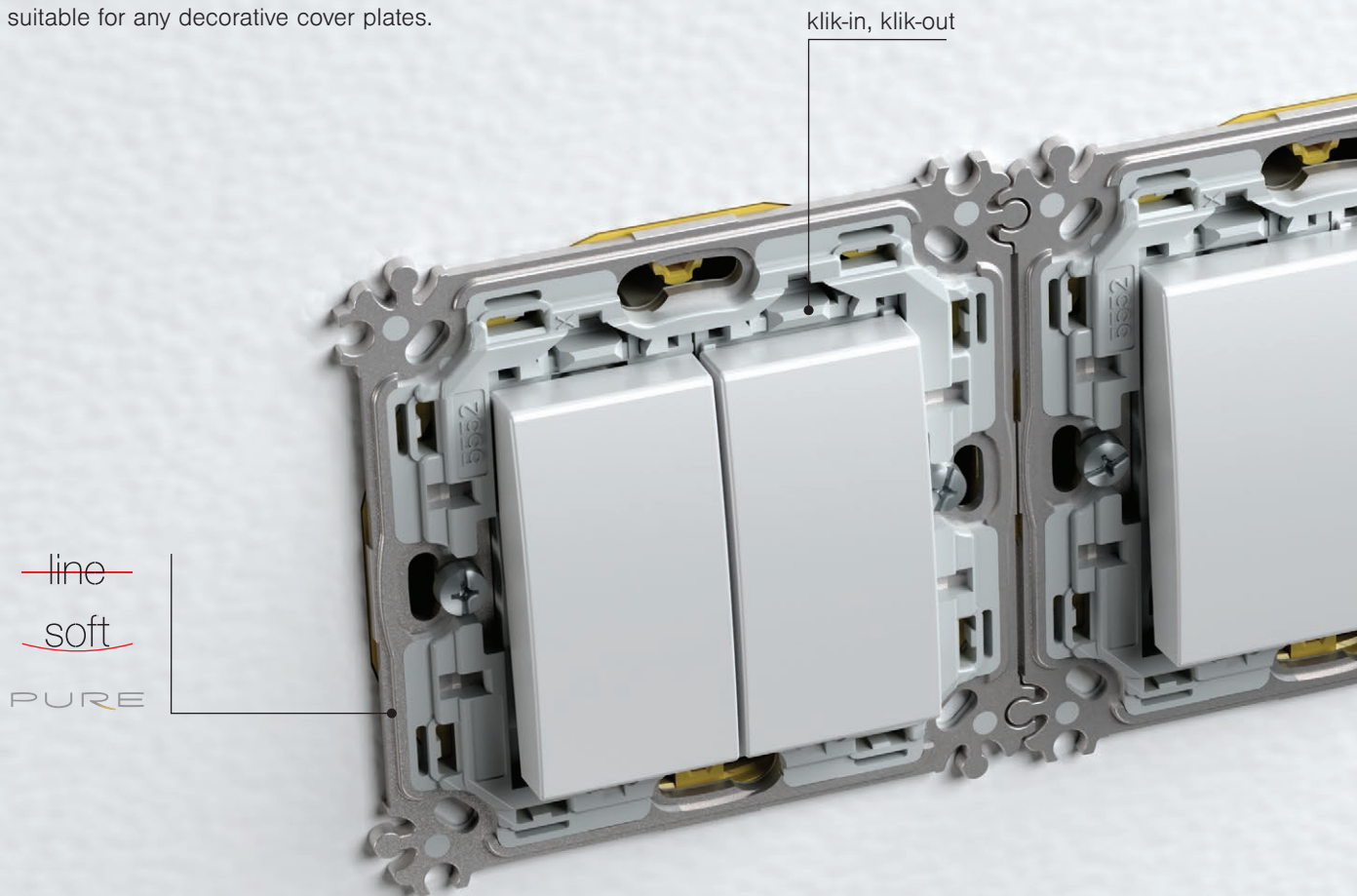

I njëjti kapak mbulues mund të pozicionohet horizontalisht ose vertikalisht.

The same cover plate can be positioned horizontally or vertically.

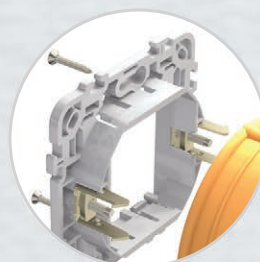

Kornizat e montimit mund të fiksohen me vida ose kapëse. Mounting frames can be fixed with screws or claws.

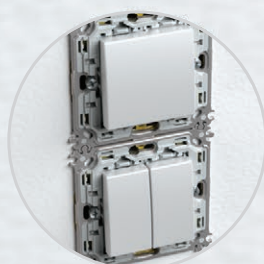
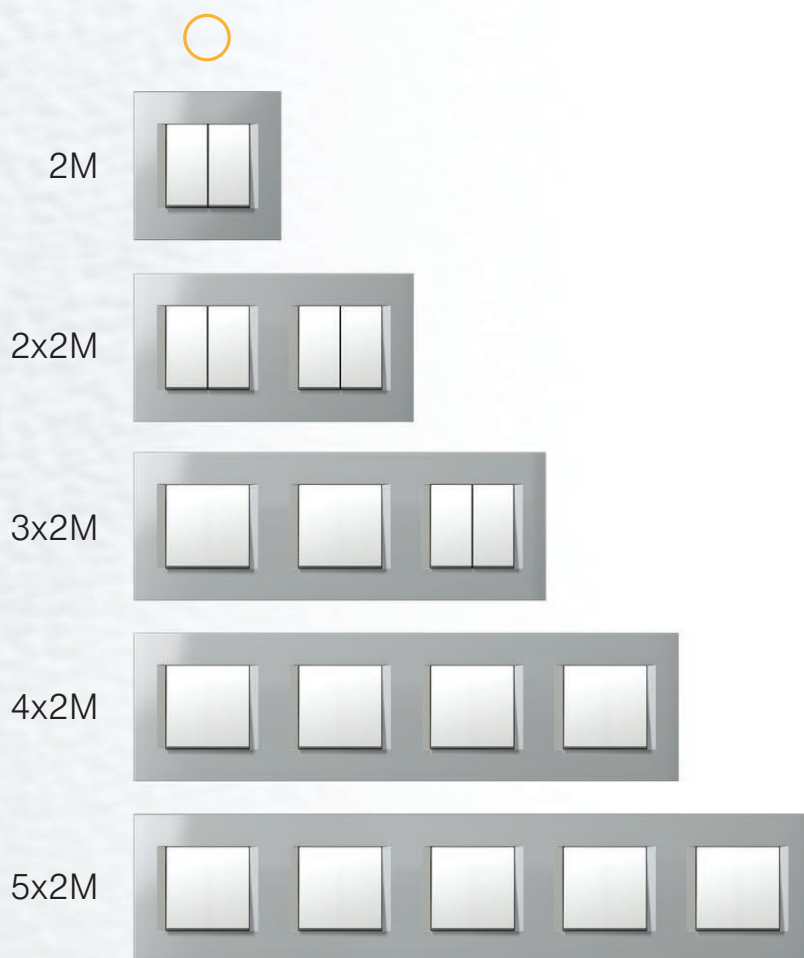
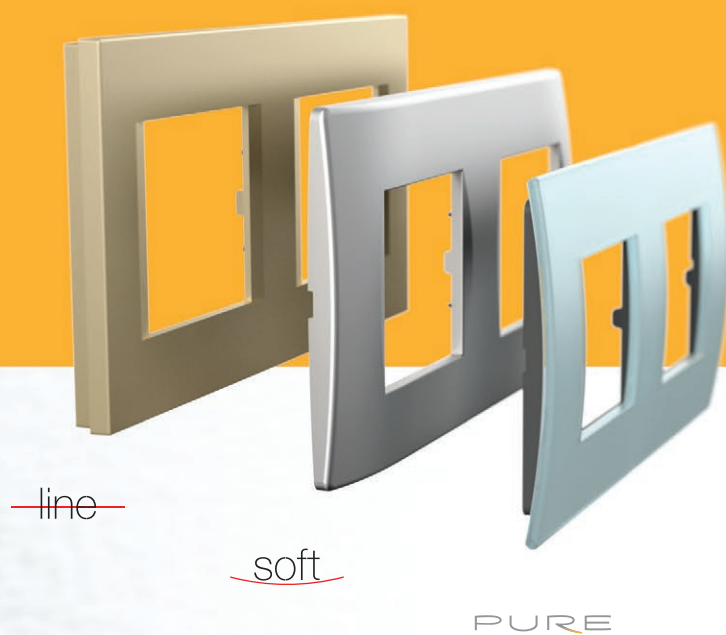

Kornizat e montimit 2M bashkohen lehtësisht në grupe.
2M mounting frames are easily joined into groups.

universaliteti

universality

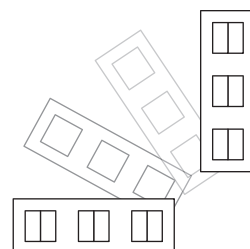
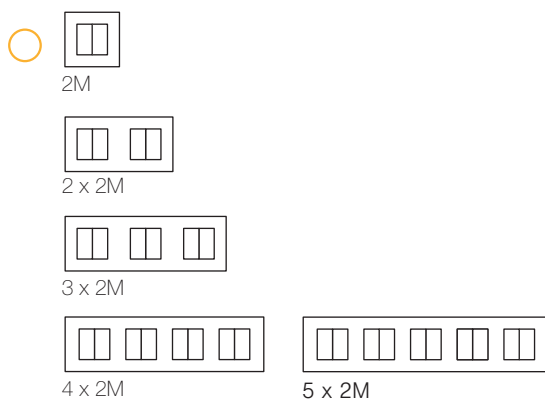
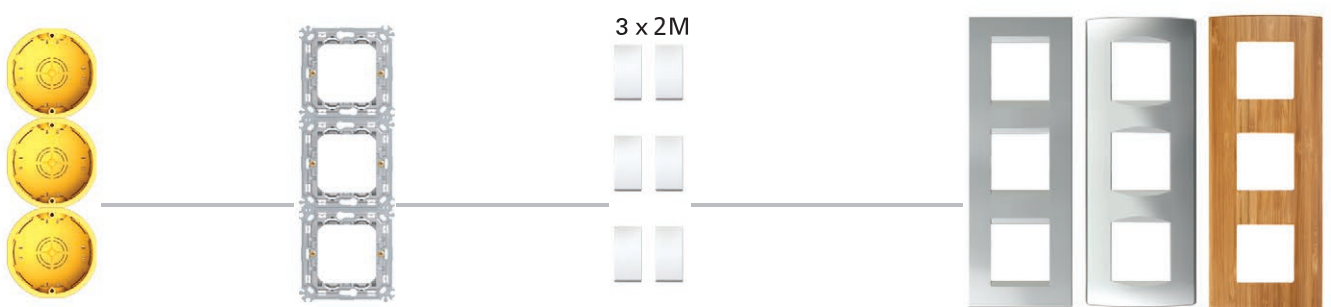
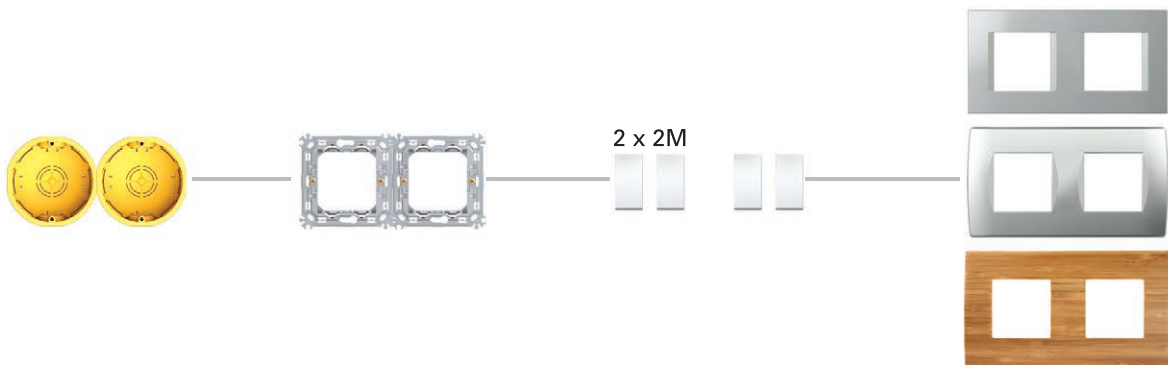
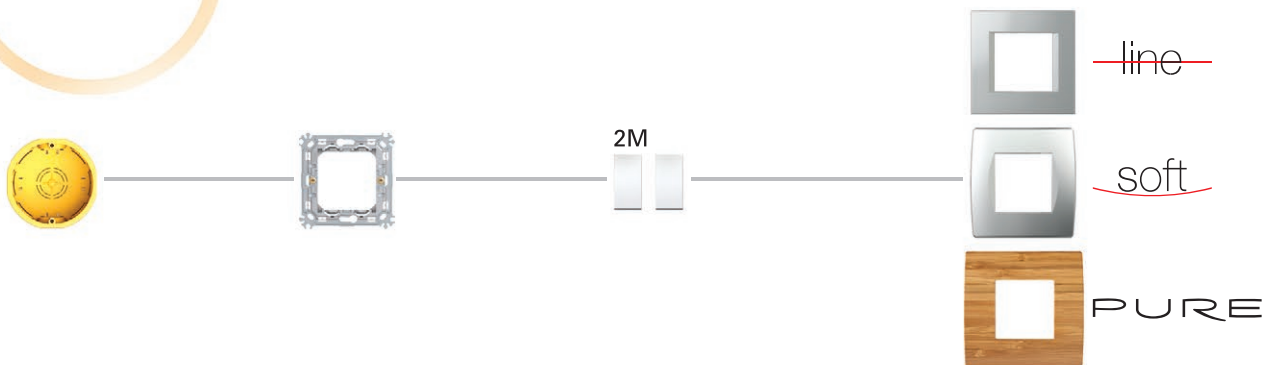

Sistemi është universal dhe mund të futet brenda kutive të rrumbullakëta dhe drejtkëndore.

The system is universal and can be fitted in both round and rectangular boxes.

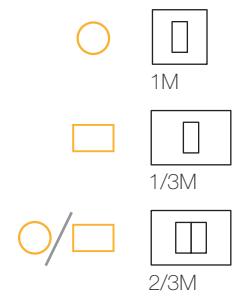
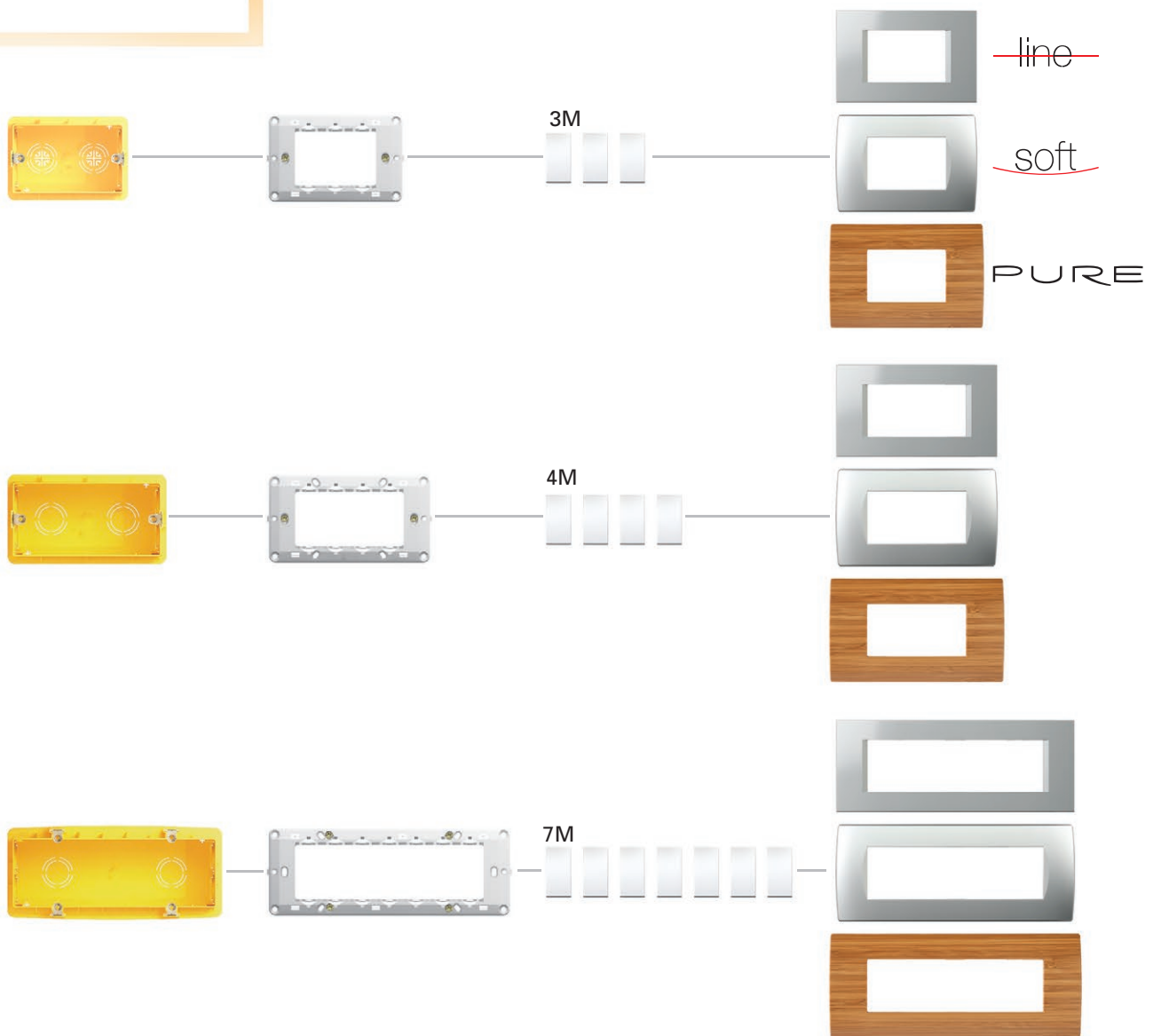
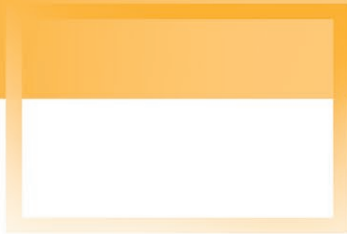

elemente funksioni

function elements

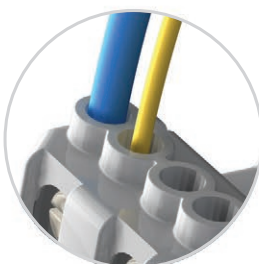
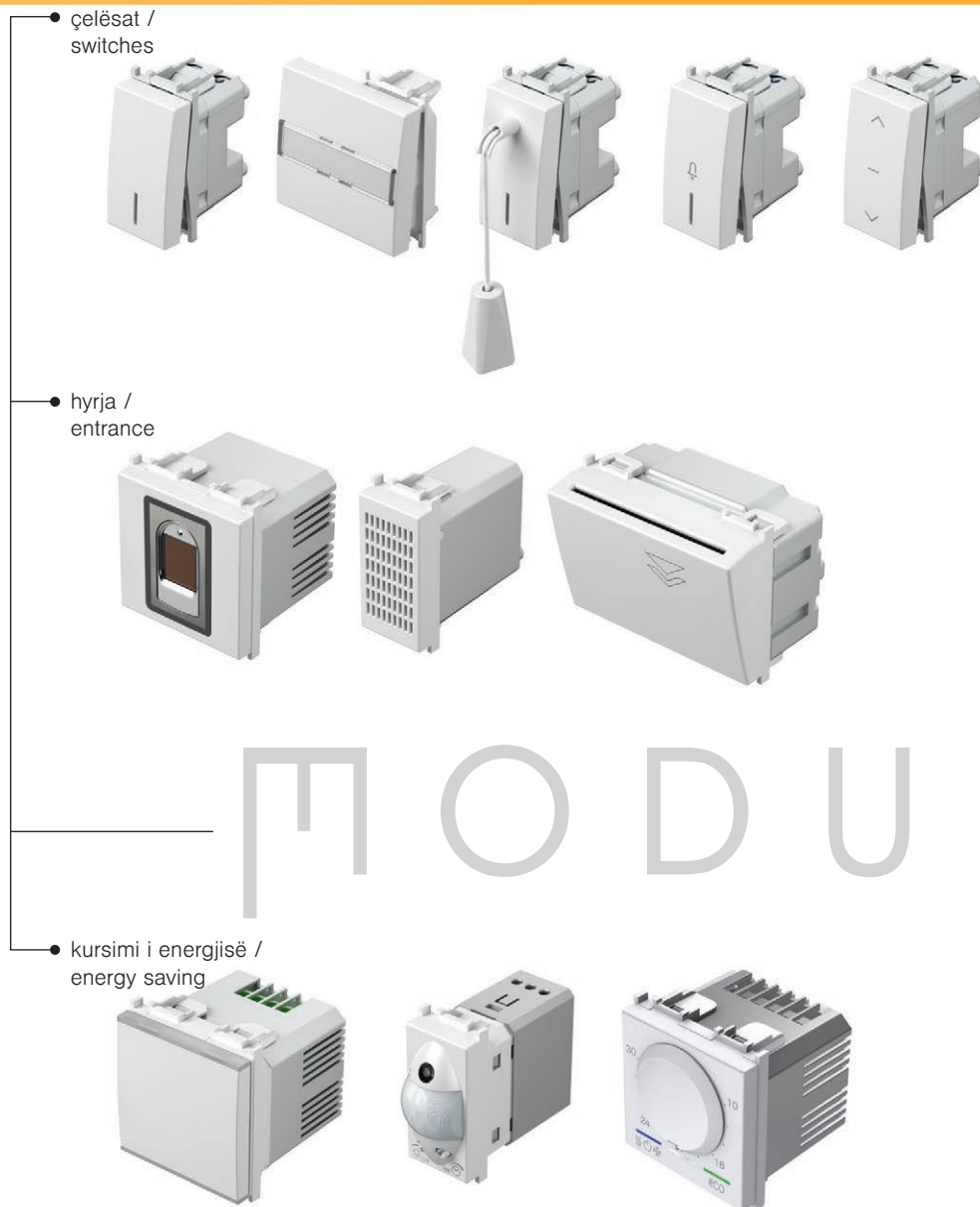

Lidhje e sigurt edhe kur përdoren madhësi të ndryshme telash.

Reliable connection even when different size of wires are used.



Jetëgjatësi e çelësve dhe përshtatje me standardet ndërkombëtare.

Long-life of switches and adequacy to the international standards.

Ne kemi një gamë të gjerë elementesh funksioni për familjen Modul. Ju mund t'i përdorni ato për krijimin e instalimeve të thjeshta ose komplekse.

We have designed a wide selection of function element for the Modul family. You can use them to design both simple and complex installations.



● prizat / sockets

● argëtimi / entertainment

● ndriçimi / illumination



Të gjitha prizat janë të pajisura me automatë sigurie që garantojnë mbrojtjen e kontakteve me rrymën.

All the sockets are equipped with a safety shutters assuring the protection to live contacts.



16 AX
kontaktet

Çelësi është shumë i sigurt përmes kontakteve të perçinave prej argjendi.

The switch is highly reliable via its silver rivets contacts.

gamë unike përdorimi

unique range of usability

Modul Soft AW
zgjidhje antibakteriale
antibacterial solution



MODUL

CUBO IP20

kuti me montim në sipërfaqe
surface mounted boxes



CUBO IP55

kuti me montim në sipërfaqe
surface mounted boxes



IP44

montim rrafsh
flush mounted



Po pajisni shtëpinë, zyrën apo ofiçinën?

Modul është i disponueshëm për hapësira banimi ose pune dhe si për ndërtesa private ashtu edhe për ato publike. Ai është unik në faktin se çelësat dhe prizat mund të vendosen kudo që të nevojiten.

Are you furnishing your home, office or workshop? The Modul is suitable for living as well as working spaces and both private and public buildings. It is unique in that the switches and sockets can be fitted wherever they are needed.

D

tullë
brick



H

mur bosh
hollow wall



B

beton
concrete

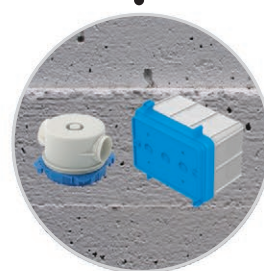

● elementet e funksionit /
function elements

çelësat / switches
prizat / sockets
komunikimet / communications
sensorët / sensors
rregullatorët / regulators
ndriçuesit / illuminations

MA

sistemet e kanalave
trunking systems



MO

qarqet e shpërndarjes
distribution boards



MT

kutitë e dyshemesë
floor boxes



zgjidhjet me montim rrafsh flush mounted solutions

tullë / brick

Modul është i përshtatshëm për të gjitha llojet e mureve dhe mund të përdoret në mure me konstruksione tradicionale, bosh ose betoni. Është e lehtë të instalohet dhe ju jep mundësinë të kombinoni kutitë drejtkëndore ose të rrumbullakëta në distancat e duhura. Materialet e përdorura janë në pajtim me standardet më të larta.

The Modul is suitable for all wall types and can be used in conventional, hollow wall or concrete constructions. It is easy to install and enables you to combine rectangular or round boxes at the proper distances. The materials used are compliant with high standards.



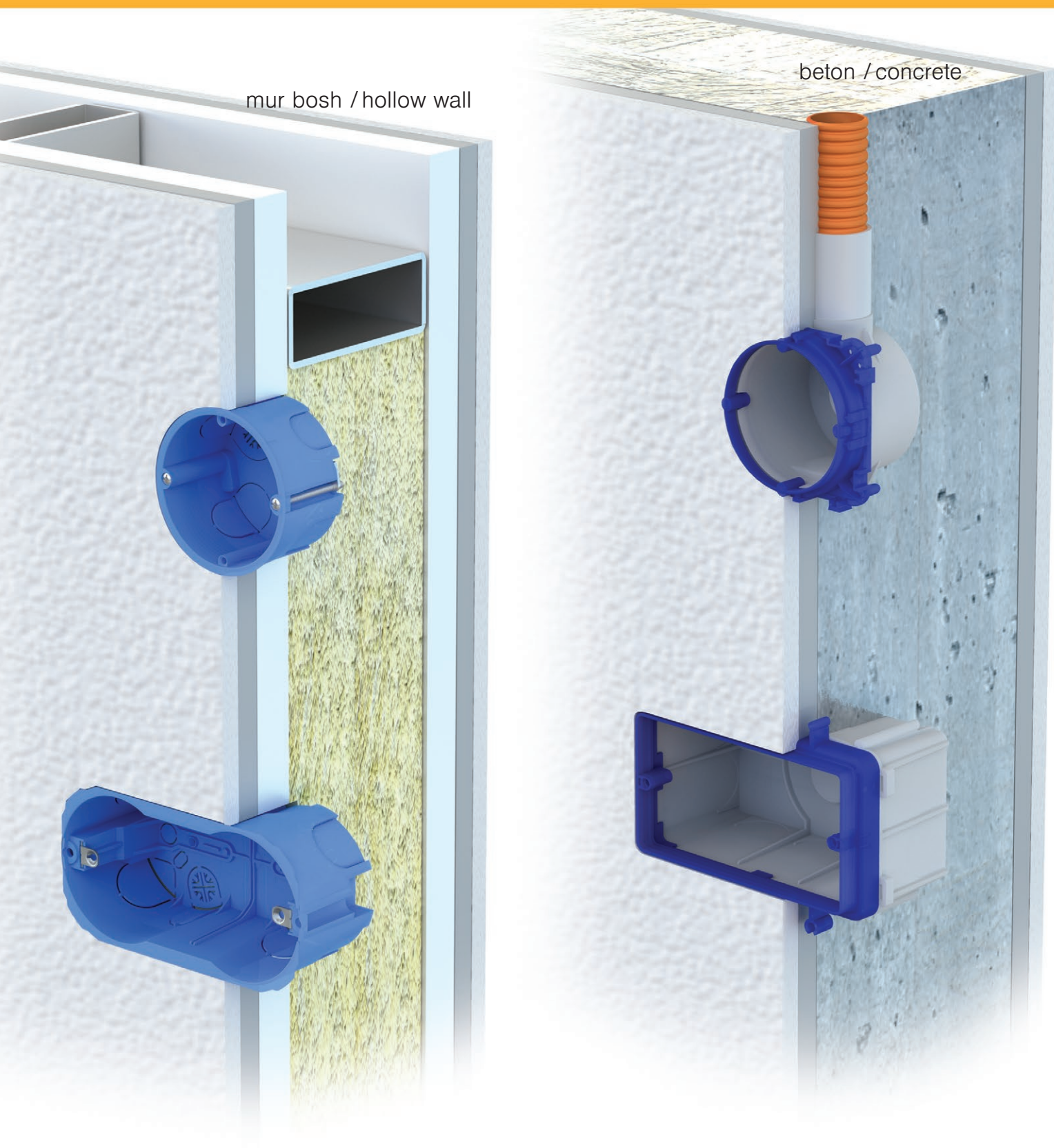

zgjdhje të tjera

other solutions

IP44
montim rrafsh
flush mounted



CUBO IP20
kuti me montim në sipërfaqe
surface mounted boxes

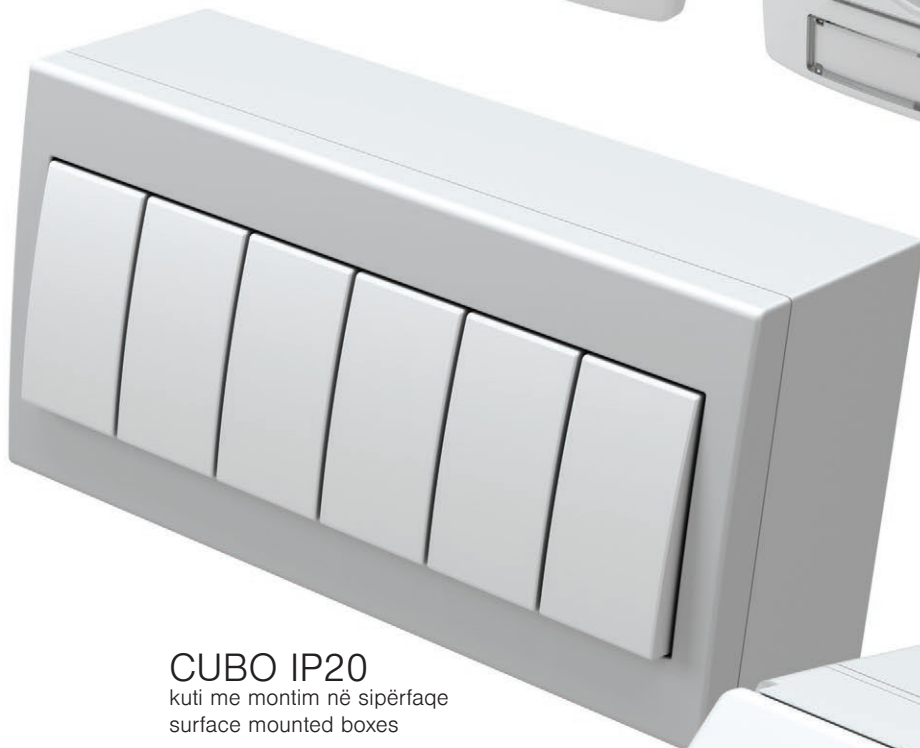

CUBO IP55
kuti me montim në sipërfaqe
surface mounted boxes



Ju nevojitet një çelës ose prizë që të jetë rrafsh, në sipërfaqe ose në dysheme? Modul ofron zgjidhje të ndryshme montimi me mbrojtje të ndryshme IP, për sistemet e kanalave, qarqet e shpërndarjes dhe kutitë e dyshemesë. Zgjedhja është juaja.

Do you need switch or socket in flush, surface or floor solution? The Modul provides different mounting solutions with different IP protections, for trunking systems, distribution boards or floor boxes. The choice is yours.



MA

sistemet e kanalave
trunking systems

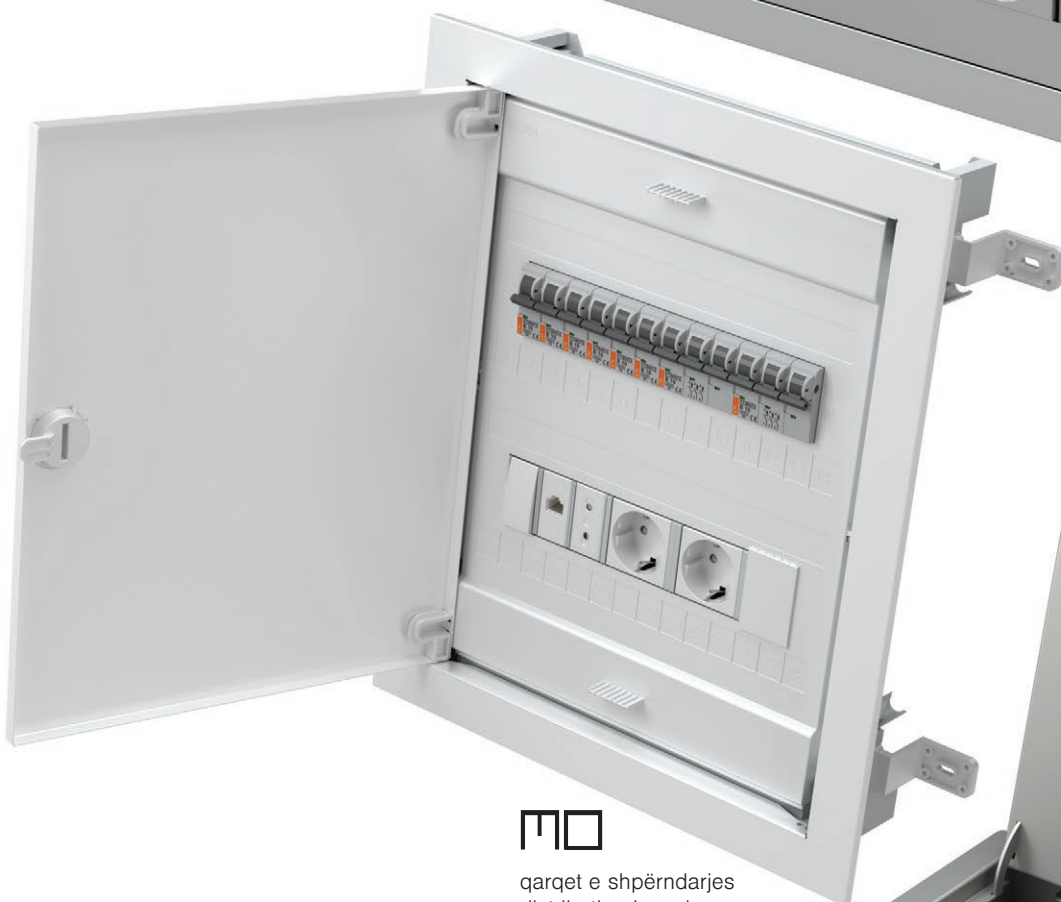

MO

qarqet e shpërndarjes
distribution boards

MT

kutitë e dyshemesë
floor boxes



katalogu teknik

technical catalogue





MODUL

— elemente funksioni
function elements



66

dizajni
design

PURE
line
soft



116

kutitë
boxes



136

shpërndarja
distribution



158

ekonomik —



182

fontana —



210

TEM



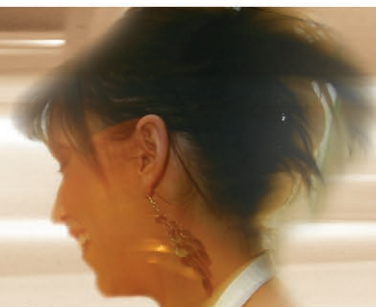

ELEMENTET E FUNKSIONIT FUNCTION ELEMENTS

ÇELËSAT SM
SWITCHES SM



68

BUTONAT TM
BUTTONS TM



73

NDRIÇUESIT IA
ILLUMINATION IA



76

PRIZAT VM
SOCKETS VM



78

KOMUNIKIMET KM
COMMUNICATIONS KM



82

AKSESORËT E KOMUNIKIMIT KA
COMMUNICATION ACCESSORIES KA



88

LIDHJET ELEKTRONIKE EM
ELECTRONICS EM



91

SETET CM
SETS CM



110

PROGRAMI ANTIBAKTERIAL AW
ANTIBACTERIAL PROGRAM AW



115

DIZAJNI DESIGN

KAPAKËT MBULUES PURE OP
COVER PLATES PURE OP



120

KAPAKËT MBULUES LINE OL
COVER PLATES LINE OL



124

KAPAKËT MBULUES SOFT OS
COVER PLATES SOFT OS



128

KORNIZAT E MONTIMIT NM
MOUNTING FRAMES NM



134

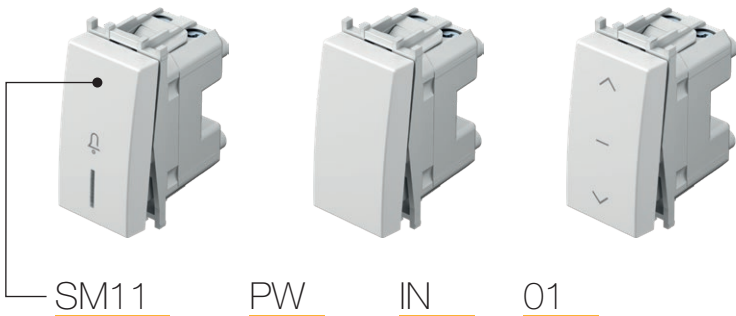

Iloji type	përshkrimi description	të dhënat teknike technical data	madhësia size	ngjyra colour	të dhënat opsionale 1 optional data 1	të dhënat opsionale 2 optional data 2
SM10	ÇELËS ME 1 DREJTIM SWITCH 1WAY	16AX 250V~	1M	<input type="checkbox"/> PW e bardhë polare polar white	<input type="checkbox"/> NT neutral neutral	01
SM11	BUTON MESHTYPJE ME 1 DREJTIM PUSH BUTTON 1WAY	16A 250V~	1M	<input type="checkbox"/> SB e zezë soft touch soft touch black	<input type="checkbox"/> IN treguesi indicator	02
SM12	ÇELËS ME 1 DREJTIM SWITCH 1WAY	20A 250V~	1M	<input type="checkbox"/> AT antracit anthracite		03
...	<input type="checkbox"/> ES e argjendtë elox elox silver		
...	<input type="checkbox"/> IW e bardhë fildishi ivory white		

ÇELËS ME 1 DREJTIM 16 A X 250 V~ 1M



SM10

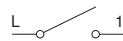

- çelës pa buton
 - 16 A X 250 V~, Iloji SM10
 - në përputhje me EN 60669-1
 - kontaktet e vidave 1,5-2,5 mm²
- SWITCH 1WAY 16AX 250V~ 1M**
- switch without button
 - 16AX 250V~, type SM10
 - in accordance with EN 60669-1
 - screw contacts 1.5-2.5mm²

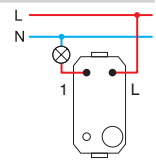

BUTON ME SHTYPJJE ME 1 DREJTIM 16 A 250 V~ 1M



SM11



- buton me shtypje pa buton
 - 16 A 250 V~, Iloji SM11
 - në përputhje me EN 60669-1
 - kontaktet e vidave 1,5-2,5 mm²
- PUSH BUTTON 1WAY 16A 250V~ 1M**
- push button without button
 - 16A 250V~, type SM11
 - in accordance with EN 60669-1
 - screw contacts 1.5-2.5mm²

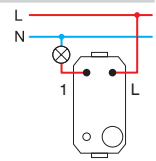

ÇELËS ME 1 DREJTIM 20 A 250 V~ 1M



SM12



- çelës pa buton
 - 20 A 250 V~, Iloji SM12
 - në përputhje me EN 60669-1
 - kontaktet e vidave 1,5-2,5 mm²
- SWITCH 1WAY 20A 250V~ 1M**
- switch without button
 - 20A 250V~, type SM12
 - in accordance with EN 60669-1
 - screw contacts 1.5-2.5mm²

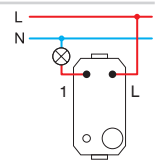

ÇELËS 2 POLAR 16 A X 250 V~ 1M



SM20

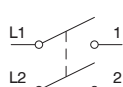

- çelës pa buton
 - 16 A X 250 V~, Iloji SM20
 - në përputhje me EN 60669-1
 - kontaktet e vidave 1,5-2,5 mm²
 - vetëm në kombinim me butonin TM15
- SWITCH 2POLE 16AX 250V~ 1M**
- switch without button
 - 16AX 250V~, type SM20
 - in accordance with EN 60669-1
 - screw contacts 1.5-2.5mm²
 - only in combination with button TM15

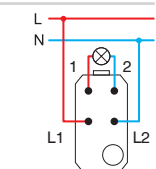

MBYLLËSE ÇELËSI 1-0-2 16 A X 250 V~ 1M



SM40

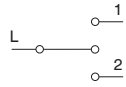

- çelës pa buton
- 16 A X 250 V~, lloji SM40
- në përputhje me EN 60669-1
- kontaktet e vidave 1,5-2,5 mm²

SWITCH SHUTTERS 1-0-2 16AX 250V~ 1M

- switch without button
- 16AX 250V~, type SM40
- in accordance with EN 60669-1
- screw contacts 1.5-2.5mm²

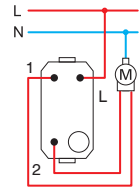

MBYLLËSE BUTONI ME SHTYPJJE 1-0-2 16 A 250 V~ 1M



SM41

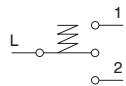

- buton me shtypje pa buton
- 16 A 250 V~, lloji SM41
- në përputhje me EN 60669-1
- kontaktet e vidave 1,5-2,5 mm²

PUSH BUTTON SHUTTERS 1-0-2 16A 250V~ 1M

- push button without button
- 16A 250V~, type SM41
- in accordance with EN 60669-1
- screw contacts 1.5-2.5mm²

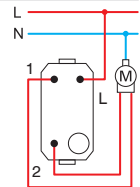

ÇELËS ME 2 DREJTIME 16 A X 250 V~ 1M



SM60

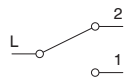

- çelës pa buton
- 16 A X 250 V~, lloji SM60
- në përputhje me EN 60669-1
- kontaktet e vidave 1,5-2,5 mm²

SWITCH 2WAY 16AX 250V~ 1M

- switch without button
- 16AX 250V~, type SM60
- in accordance with EN 60669-1
- screw contacts 1.5-2.5mm²

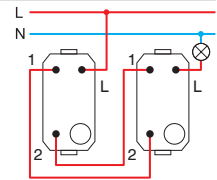

BUTON ME SHTYPJJE ME 2 DREJTIME 16 A 250 V~ 1M



SM61

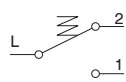

- buton me shtypje pa buton
- 16 A 250 V~, lloji SM61
- në përputhje me EN 60669-1
- kontaktet e vidave 1,5-2,5 mm²

PUSH BUTTON 2WAY 16A 250V~ 1M

- push button without button
- 16A 250V~, type SM61
- in accordance with EN 60669-1
- screw contacts 1.5-2.5mm²

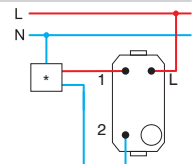

* lidhjet elektronike / electronics

ÇELËS NDËRMJETËS 16 A X 250 V~ 1M



SM70

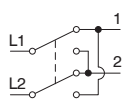

- çelës pa buton
- 16 A X 250 V~, lloji SM70
- në përputhje me EN 60669-1
- kontaktet e vidave 1,5-2,5 mm²

SWITCH INTERMEDIATE 16AX 250V~ 1M

- switch without button
- 16AX 250V~, type SM70
- in accordance with EN 60669-1
- screw contacts 1.5-2.5mm²

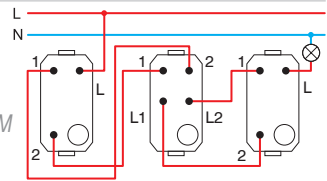

1M = 22,5 x 45
2M = 45 x 45

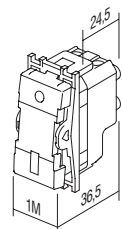
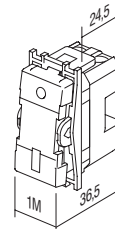



□ PW e bardhë polare
polar white



■ SB e zezë soft touch
soft touch black



■ AT antracit
anthracite



□ ES e argjendtë elox
elox silver



□ IW e bardhë fildishi
ivory white

ÇELËS ME 1 DREJTIM 16 A X 250 V~ 1M

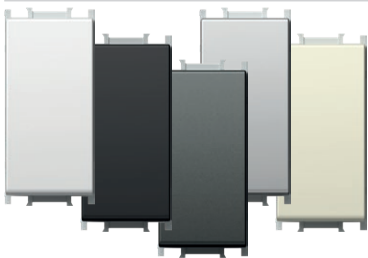

- SM10PW
- SM10SB
- SM10AT
- SM10ES
- SM10IW

- 16 A X 250 V~, Iloji SM10
- në përputhje me EN 60669-1
- kontaktet e vidave 1,5-2,5 mm²
- buton i ndërrueshëm

SWITCH 1WAY 16AX 250V~ 1M
- 16AX 250V~, type SM10
- in accordance with EN 60669-1
- screw contacts 1.5-2.5 mm²
- replaceable button



ÇELËS ME 1 DREJTIM 16 A X 250 V~ 1M __ IN



- SM10PWIN
- SM10SBIN
- SM10ATIN
- SM10ESIN
- SM10IWIN

- IN tregues
- 16 A X 250 V~, Iloji SM10
- në përputhje me EN 60669-1
- kontaktet e vidave 1,5-2,5 mm²
- llamba nuk është e përfshirë
- buton i ndërrueshëm

SWITCH 1WAY 16AX 250V~ 1M __ IN
- IN indicator
- 16AX 250V~, type SM10
- in accordance with EN 60669-1
- screw contacts 1.5-2.5 mm²
- lamp is not included
- replaceable button



BUTON ME SHYTPJE ME 1 DREJTIM 16 A 250 V~ 1M

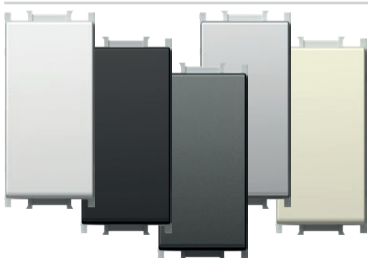

- SM11PW
- SM11SB
- SM11AT
- SM11ES
- SM11IW

- 16 A 250 V~, Iloji SM11
- në përputhje me EN 60669-1
- kontaktet e vidave 1,5-2,5 mm²
- buton i ndërrueshëm

PUSH BUTTON 1WAY 16A 250V~ 1M
- 16A 250V~, type SM11
- in accordance with EN 60669-1
- screw contacts 1.5-2.5 mm²
- replaceable button



BUTON ME SHYTPJE ME 1 DREJTIM 16 A 250 V~ 1M __ IN 01



- SM11PWIN01
- SM11SBIN01
- SM11ATIN01
- SM11ESIN01
- SM11IWIN01

- IN 01 zile treguese
- 16 A 250 V~, Iloji SM11
- në përputhje me EN 60669-1
- kontaktet e vidave 1,5-2,5 mm²
- llamba nuk është e përfshirë
- buton i ndërrueshëm

PUSH BUTTON 1WAY 16A 250V~ 1M __ IN 01
- IN 01 indicator bell
- 16A 250V~, type SM11
- in accordance with EN 60669-1
- screw contacts 1.5-2.5 mm²
- lamp is not included
- replaceable button



BUTON ME SHYTPJE ME 1 DREJTIM 16 A 250 V~ 1M __ IN 02



- SM11PWIN02 - IN 02 dritë treguese
- SM11SBIN02 - 16 A 250 V~, Iloji SM11
- SM11ATIN02 - në përputhje me EN 60669-1
- SM11ESIN02 - kontaktet e vidave 1,5-2,5 mm²
- SM11WIN02 - llamba nuk është e përfshirë
- SM11WIN02 - buton i ndërrueshëm

PUSH BUTTON 1WAY 16A 250V~ 1M __ IN 02

- IN 02 indicator light
- 16A 250V~, type SM11
- in accordance with EN 60669-1
- screw contacts 1.5-2.5 mm²
- lamp is not included
- replaceable button



ÇELËS 2 POLAR 16 A X 250 V~ 1M __ NT 03



- SM20PWNT03 - NT 03 neutral 0-1
- SM20SBNT03 - 16 A X 250 V~, Iloji SM20
- SM20ATNT03 - në përputhje me EN 60669-1
- SM20ESNT03 - kontaktet e vidave 1,5-2,5 mm²
- SM20WIN03 - buton i ndërrueshëm

SWITCH 2POLE 16AX 250V~ 1M __ NT 03

- NT 03 neutral 0-1
- 16AX 250V~, type SM20
- in accordance with EN 60669-1
- screw contacts 1.5-2.5 mm²
- replaceable button



ÇELËS 2 POLAR 16 A X 250 V~ 1M __ IN



- SM20PWIN - IN tregues
- SM20SBIN - 16 A X 250 V~, Iloji SM20
- SM20ATIN - në përputhje me EN 60669-1
- SM20ESIN - kontaktet e vidave 1,5-2,5 mm²
- SM20WIN - llamba nuk është e përfshirë
- SM20WIN - buton i ndërrueshëm

SWITCH 2POLE 16AX 250V~ 1M __ IN

- IN indicator
- 16AX 250V~, type SM20
- in accordance with EN 60669-1
- screw contacts 1.5-2.5 mm²
- lamp is not included
- replaceable button



MBYLLËSE ÇELËSI 1-0-2 16 A X 250 V~ 1M __ NT 10

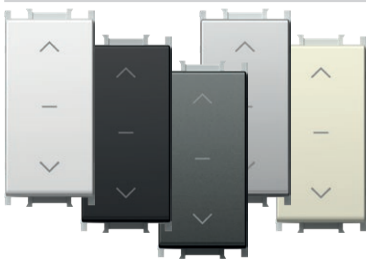

- SM40PWNT10 - NT 10 neutral 1-0-2
- SM40SBNT10 - 16 A X 250 V~, Iloji SM40
- SM40ATNT10 - në përputhje me EN 60669-1
- SM40ESNT10 - kontaktet e vidave 1,5-2,5 mm²
- SM40WIN10 - buton i ndërrueshëm

SWITCH SHUTTERS 1-0-2 16AX 250V~ 1M __ NT 10

- NT 10 neutral 1-0-2
- 16AX 250V~, type SM40
- in accordance with EN 60669-1
- screw contacts 1.5-2.5mm²
- replaceable button



MBYLLËSE BUTONI ME SHYTPJE 1-0-2 16 A 250 V~ 1M __ NT 10

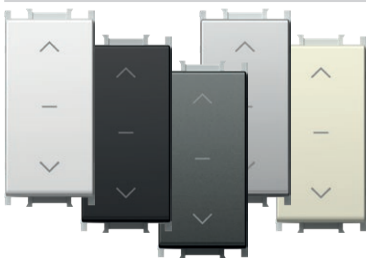

- SM41PWNT10 - NT 10 neutral 1-0-2
- SM41SBNT10 - 16 A 250 V~, Iloji SM41
- SM41ATNT10 - në përputhje me EN 60669-1
- SM41ESNT10 - kontaktet e vidave 1,5-2,5 mm²
- SM41WIN10 - buton i ndërrueshëm

PUSH BUTTON SHUTTERS 1-0-2 16A 250V~ 1M __ NT 10

- NT 10 neutral 1-0-2
- 16A 250V~, type SM41
- in accordance with EN 60669-1
- screw contacts 1.5-2.5mm²
- replaceable button



ÇELËS ME 2 DREJTIME 16 A X 250 V~ 1M



- SM60PW - 16 A X 250 V~, Iloji SM60
- SM60SB - në përputhje me EN 60669-1
- SM60AT - kontaktet e vidave 1,5-2,5 mm²
- SM60ES - buton i ndërrueshëm
- SM60IW

SWITCH 2WAY 16AX 250V~ 1M

- 16AX 250V~, type SM60
- in accordance with EN 60669-1
- screw contacts 1.5-2.5 mm²
- replaceable button



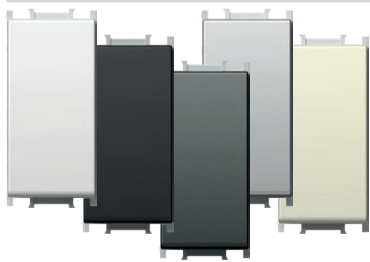

- SM61PW
- SM61SB
- SM61AT
- SM61ES
- SM61IW

BUTON ME SHYTPJE ME 2 DREJTIME 16 A 250 V~ 1M

- 16 A 250 V~, Iloji SM61
- në përputhje me EN 60669-1
- kontaktet e vidave 1,5-2,5 mm²
- buton i ndërrueshëm

PUSH BUTTON 2WAY 16A 250V~ 1M

- 16A 250V~, type SM61
- in accordance with EN 60669-1
- screw contacts 1.5-2.5 mm²
- replaceable button



- SM62PWCD
- SM62SBCD
- SM62ATCD
- SM62ESCD
- SM62IWCD

BUTON ME SHYTPJE ME 2 DREJTIME ME KORDON 16 A 250 V~ 1M __ CD

- CD treguesi+kordonit
- gjatësia e kordonit 1,5 m
- 16 A 250 V~, Iloji SM62
- në përputhje me EN 60669-1
- kontaktet e vidave 1,5-2,5 mm²

PUSH BUTTON 2WAY WITH CORD 16A 250V~ 1M __ CD

- CD indicator+cord
- cord lenght 1.5m
- 16A 250V~, type SM62
- in accordance with EN 60669-1
- screw contacts 1.5-2.5 mm²



- SM70PW
- SM70SB
- SM70AT
- SM70ES
- SM70IW

ÇELËS NDËRMJETËS 16 A X 250 V~ 1M

- 16 A X 250 V~, Iloji SM70
- në përputhje me EN 60669-1
- kontaktet e vidave 1,5-2,5 mm²
- buton i ndërrueshëm

SWITCH INTERMEDIATE 16AX 250V~ 1M

- 16AX 250V~, type SM70
- in accordance with EN 60669-1
- screw contacts 1.5-2.5 mm²
- replaceable button



1M = 22,5 x 45
2M = 45 x 45

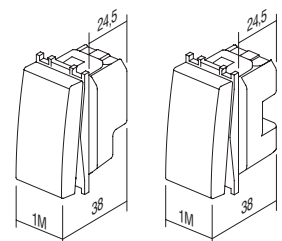

B U T T O N S T M

Iloji type	përshkrimi description	madhësia size	ngjyra colour	të dhënat opsionale 1 optional data 1	të dhënat opsionale 2 optional data 2
TM11	BUTON BUTTON	1M	□ PW e bardhë polare polar white	NT neutral neutral	🔔 01
TM12	BUTON BUTTON	2M	■ SB e zezë soft touch soft touch black	IN treguesi indicator	🔔 02
TM21	FALSO BLANK	1M	■ AT antracit anthracite		0 03
⋮	⋮	⋮	□ ES e argjendtë elox elox silver		
⋮	⋮	⋮	■ IW e bardhë fildishi ivory white		

BUTON 1M



- TM11PW
- TM11SB
- TM11AT
- TM11ES
- TM11IW

- buton i ndërrueshëm 1M
- në përputhje me EN 60669-1

BUTON 1M

- replaceable button 1M
- in accordance with EN 60669-1



TREGUES BUTONI 1M



- TM11PWIN
- TM11ATIN
- TM11SBIN
- TM11ESIN
- TM11IWIN

- buton i ndërrueshëm 1M
- në përputhje me EN 60669-1

BUTON 1M INDICATOR

- replaceable button 1M
- in accordance with EN 60669-1



BUTON 2M

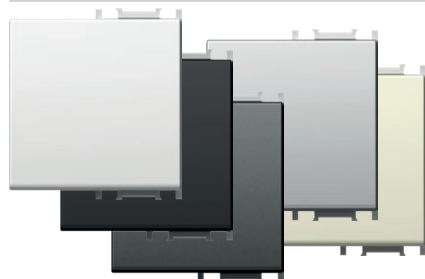

- TM12PW
- TM12SB
- TM12AT
- TM12ES
- TM12IW

- buton i ndërrueshëm 2M me mbajtëse butoni
- për të përditësuar çelësin ose butonin me shtypje nga madhësia 1M në madhësinë 2M
- në përputhje me EN 60669-1

BUTON 2M

- replaceable button 2M with button carrier
- to upgrade switch or push button from size 1M to size 2M
- in accordance with EN 60669-1



TREGUES BUTONI 2M

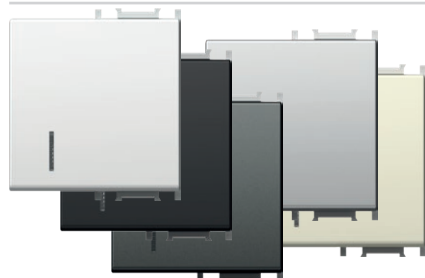

- TM12PWIN
- TM12SBIN
- TM12ATIN
- TM12ESIN
- TM12IWIN

- buton i ndërrueshëm 2M me mbajtëse butoni
- për të përditësuar çelësin ose butonin me shtypje nga madhësia 1M në madhësinë 2M
- në përputhje me EN 60669-1

BUTON 2M INDICATOR

- replaceable button 2M with button carrier
- to upgrade switch or push button from size 1M to size 2M
- in accordance with EN 60669-1



BUTON 2M ME KAPAK ME MBISHKRIM

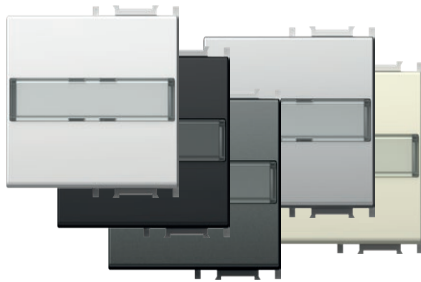

- TM13PWIL
- TM13SBIL
- TM13ATIL
- TM13ESIL
- TM13IWIL

- buton i ndërrueshëm 2M me mbajtëse butoni
 - për të përditësuar çelësin ose butonin me shtypje nga madhësia 1M në madhësinë 2M
 - në përputhje me EN 60669-1

BUTTON 2M WITH INSCRIPTION PLATE

- replaceable button 2M with button carrier
 - to upgrade switch or push button from size 1M to size 2M
 - in accordance with EN 60669-1



BUTON 1M 2 POLAR

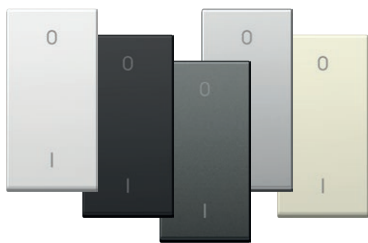

- TM15PW
- TM15SB
- TM15AT
- TM15ES
- TM15IW

- buton i ndërrueshëm 1M
 - vetëm në kombinim me mekanizmin SM20
 - në përputhje me EN 60669-1

BUTTON 1M 2POLE

- replaceable button 1M
 - only in combination with mechanism SM20
 - in accordance with EN 60669-1



FALSO 1M

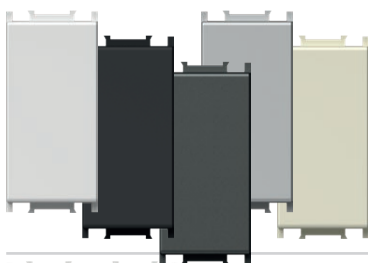

- TM21PW
- TM21SB
- TM21AT
- TM21ES
- TM21IW

- modul falso për të mbushur hapësirat boshe
 - në përputhje me EN 60669-1

BLANK 1M

- blank modul to fill up empty spaces
 - in accordance with EN 60669-1



FALSO 2M



- TM22PW
- TM22SB
- TM22AT
- TM22ES
- TM22IW

- modul falso për të mbushur hapësirat boshe
 - në përputhje me EN 60669-1

BLANK 2M

- blank modul to fill up empty spaces
 - in accordance with EN 60669-1



DALJE PËR KABLO 1M

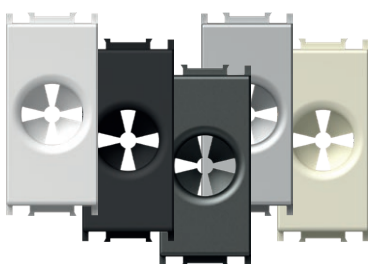

- TM31PW
- TM31SB
- TM31AT
- TM31ES
- TM31IW

- dalje për kablo
 - në përputhje me EN-60669-1

CABLE OUTLET 1M

- outlet for cable
 - in accordance with EN-60669-1



1M = 22,5 x 45
 2M = 45 x 45

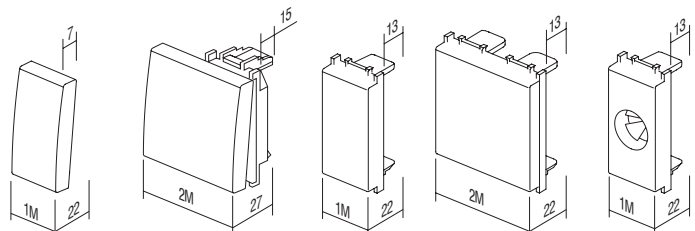

TM11
TM15

TM12
TM13

TM21

TM22

TM31

B U T T O N S T M

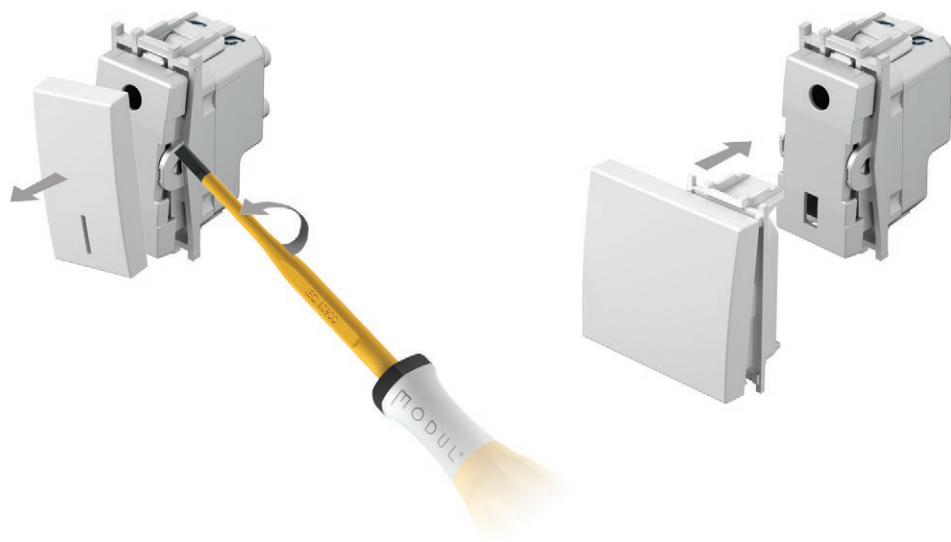

PRINTIM ME LAZER MBI BUTONA

- printim me lazer i çdo lloj grafike në vendet e shënuara
- simbole standarde nga stoku, të tjerat sipas kërkesës

LASER PRINT ON BUTTONS

- laser print of any graphics on marked locations
- standard symbols from stock, other on request

1M

A
B
C

2M

A	D	G
B	E	H
C	F	I

SIMBOLET

SYMBOLS

01	02	03	04	05	06	07	08	09	10	11	12	20	21	22	23
24	25	26	27	28	29	30	31	32	33	34	35	36	37	38	39
					OFF	ON					AC				
40	41	42	43	44	45	46	47	48							

SIMBOLET STANDARDE

STANDARD SYMBOLS

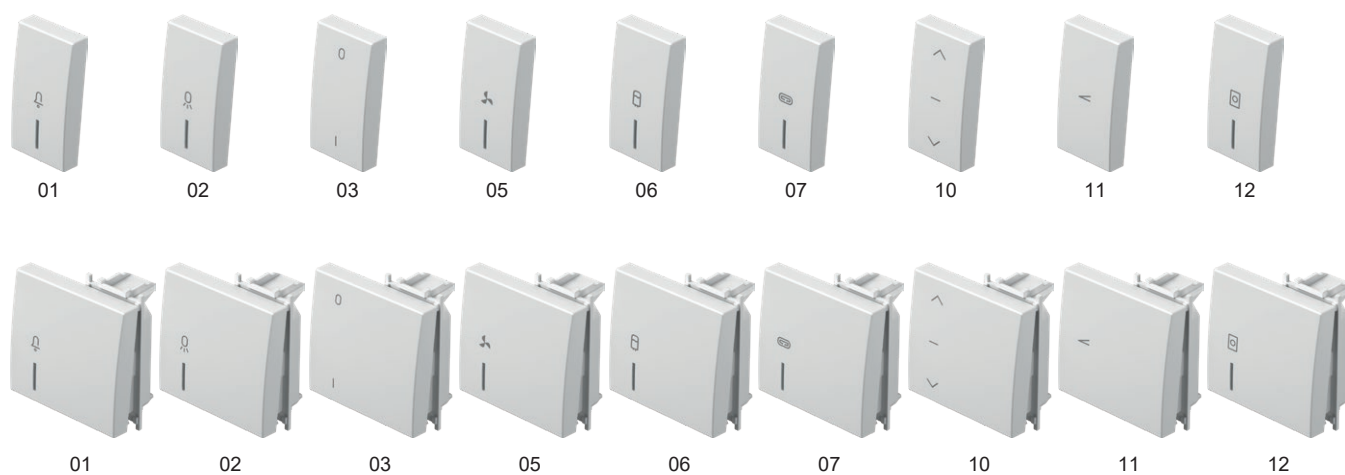

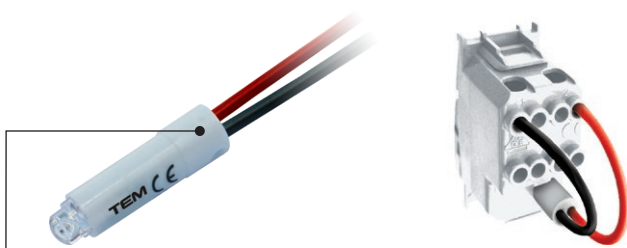

IA20

WH

Iloji type	përshkrimi description	të dhënat teknike technical data	ngjyra colour
IA10	LLAMBË NEONI NEON LAMP	230V~ 0,34W	<input type="checkbox"/> WH e bardhë white
IA20	LLAMBË LED LED LAMP	230V~ AC/DC 0,40W	<input checked="" type="checkbox"/> BL blu blue
IA21	LLAMBË LED LED LAMP	24V AC/DC 0,20W	<input checked="" type="checkbox"/> RD e kuqe red
·	·	·	<input checked="" type="checkbox"/> GR e gjelbër green
·	·	·	<input checked="" type="checkbox"/> OR portokalli orange

LLAMBË NEONI 230 V~ 0,34 W



IA10OR

- si tregues, për ndriçim ose ndriçim konstant të çelësit
- në kombinim me butonin me tregues
NEON LAMP 230V~ 0,34W
- for indication, illumination or constant illumination of switch
- in combination with button with indicator

LLAMBË LED 230 V AC/DC 0,40 W



IA20WH
 IA20GR
 IA20RD
 IA20BL

- si tregues, për ndriçim ose ndriçim konstant të çelësit
- në kombinim me butonin me tregues
LED LAMP 230V AC/DC 0,40W
- for indication, illumination or constant illumination of switch
- in combination with button with indicator

LLAMBË LED 24V AC/DC 0,20W



IA21WH
 IA21RD

- si tregues, për ndriçim ose ndriçim konstant të çelësit
- në kombinim me butonin me tregues
LED LAMP 24V AC/DC 0,20W
- for indication, illumination or constant illumination of switch
- in combination with button with indicator

LLAMBË LED 12V AC/DC 0,10W



IA22WH
 IA22RD

- si tregues, për ndriçim ose ndriçim konstant të çelësit
- në kombinim me butonin me tregues
LED LAMP 12V AC/DC 0,10W
- for indication, illumination or constant illumination of switch
- in combination with button with indicator

QARK RC 250 V~



IA50

- qark RC për të eliminuar ndërhyrjet në funksionim të llambave LED
- lidhje paralele me më shumë qarqe RC dhe llamba janë të mundshme
- 0,1 µF, 100 Ω, 250V~
RC CIRCUIT 250V~
- RC circuit to eliminate disturbances in the operation of LED lamps
- parallel connections of more RC circuits with lamps are possible
- 0,1 µF, 100 Ω, 250V~

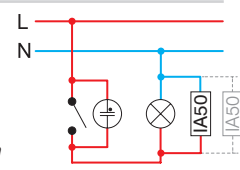

* Treguesi /
Indication

Ndriçimi /
Illumination

Ndriçim konstant /
Constant illumination

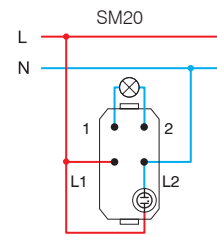
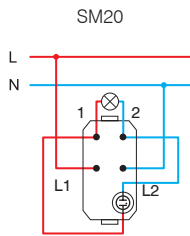
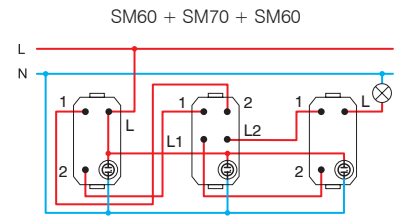
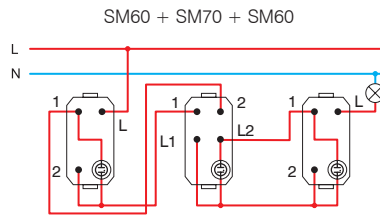
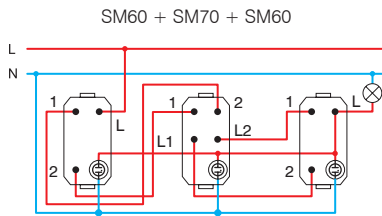
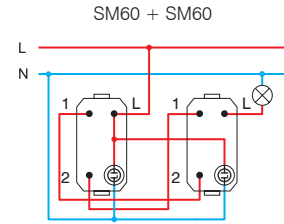
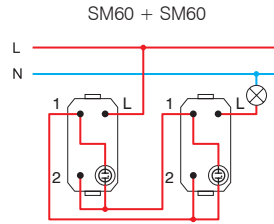
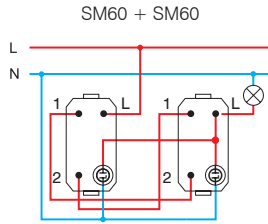
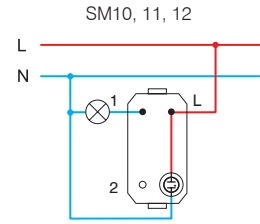
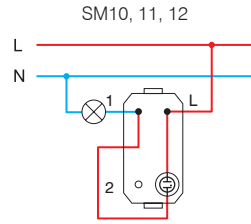
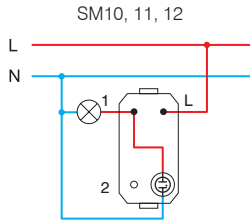

* skema elektrike për llambë kompakte fluide (CFL, LED)
wiring scheme for energy saving lamps (CFL, LED)

1M = 22,5 x 45
2M = 45 x 45

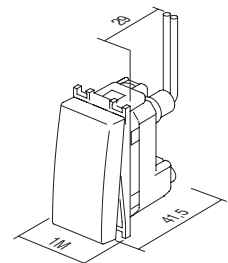

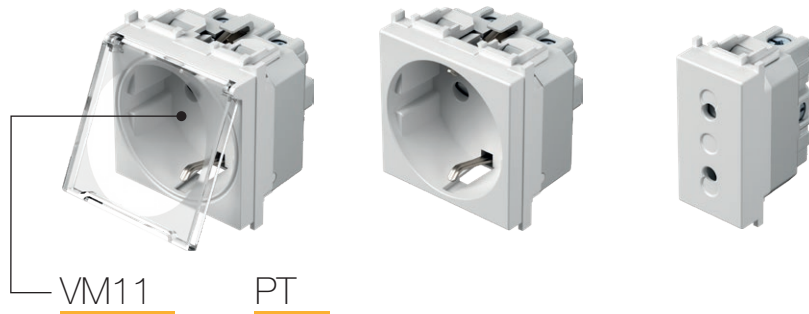

lloji type	përshkrimi description	të dhënat teknike technical data	madhësia size	ngjyra colour																		
VM10	PRIZË SCHUKO+KS SOCKET SCHUKO+KS	2P+E 16A 250V~	2M	<table border="0"> <tr> <td><input type="checkbox"/> PW e bardhë polare polar white</td> <td><input checked="" type="checkbox"/> PT e bardhë+transparente white+transparent</td> <td><input type="checkbox"/> PP e bardhë+e bardhë white+white</td> </tr> </table>	<input type="checkbox"/> PW e bardhë polare polar white	<input checked="" type="checkbox"/> PT e bardhë+transparente white+transparent	<input type="checkbox"/> PP e bardhë+e bardhë white+white															
<input type="checkbox"/> PW e bardhë polare polar white	<input checked="" type="checkbox"/> PT e bardhë+transparente white+transparent	<input type="checkbox"/> PP e bardhë+e bardhë white+white																				
VM11	PRIZË SCHUKO+KS+KAPAK SOCKET SCHUKO+KS+COVER	2P+E 16A 250V~	2M	<table border="0"> <tr> <td><input checked="" type="checkbox"/> SB e zezë soft touch soft touch black</td> <td><input checked="" type="checkbox"/> BT e zezë+transparente black+transparent</td> <td><input checked="" type="checkbox"/> BB e zezë+e zezë soft touch black+black</td> </tr> </table>	<input checked="" type="checkbox"/> SB e zezë soft touch soft touch black	<input checked="" type="checkbox"/> BT e zezë+transparente black+transparent	<input checked="" type="checkbox"/> BB e zezë+e zezë soft touch black+black															
<input checked="" type="checkbox"/> SB e zezë soft touch soft touch black	<input checked="" type="checkbox"/> BT e zezë+transparente black+transparent	<input checked="" type="checkbox"/> BB e zezë+e zezë soft touch black+black																				
VM20	PRIZË EURO+KS SOCKET EURO+KS	2P 10A 250V~	1M	<table border="0"> <tr> <td><input checked="" type="checkbox"/> AT antracit anthracite</td> <td><input checked="" type="checkbox"/> AT antracit+transparente anthracite+transparent</td> <td><input checked="" type="checkbox"/> AA antracit+antracit anthracite+anthracite</td> </tr> <tr> <td><input checked="" type="checkbox"/> ES e argjendtë elox elox silver</td> <td><input checked="" type="checkbox"/> ST e argjendtë+transparente silver+transparent</td> <td><input checked="" type="checkbox"/> SS e argjendtë+e argjendtë silver+silver</td> </tr> <tr> <td><input checked="" type="checkbox"/> IW e bardhë filishi ivory white</td> <td><input checked="" type="checkbox"/> IT e fildishtë+transparente ivory+transparent</td> <td><input checked="" type="checkbox"/> II e fildishtë+e fildishtë ivory+ivory</td> </tr> <tr> <td><input checked="" type="checkbox"/> RD e kuqe red</td> <td><input checked="" type="checkbox"/> RT e kuqe+transparente red+transparent</td> <td><input checked="" type="checkbox"/> RR e kuqe+e kuqe red+red</td> </tr> <tr> <td><input checked="" type="checkbox"/> GR e gjelbër green</td> <td><input checked="" type="checkbox"/> GT e gjelbër+transparente green+transparent</td> <td><input checked="" type="checkbox"/> GG e gjelbër+e gjelbër green+green</td> </tr> <tr> <td><input checked="" type="checkbox"/> OR portokalli orange</td> <td><input checked="" type="checkbox"/> OT portokalli+transparente orange+transparent</td> <td><input checked="" type="checkbox"/> OO portokalli+portokalli orange+orange</td> </tr> </table>	<input checked="" type="checkbox"/> AT antracit anthracite	<input checked="" type="checkbox"/> AT antracit+transparente anthracite+transparent	<input checked="" type="checkbox"/> AA antracit+antracit anthracite+anthracite	<input checked="" type="checkbox"/> ES e argjendtë elox elox silver	<input checked="" type="checkbox"/> ST e argjendtë+transparente silver+transparent	<input checked="" type="checkbox"/> SS e argjendtë+e argjendtë silver+silver	<input checked="" type="checkbox"/> IW e bardhë filishi ivory white	<input checked="" type="checkbox"/> IT e fildishtë+transparente ivory+transparent	<input checked="" type="checkbox"/> II e fildishtë+e fildishtë ivory+ivory	<input checked="" type="checkbox"/> RD e kuqe red	<input checked="" type="checkbox"/> RT e kuqe+transparente red+transparent	<input checked="" type="checkbox"/> RR e kuqe+e kuqe red+red	<input checked="" type="checkbox"/> GR e gjelbër green	<input checked="" type="checkbox"/> GT e gjelbër+transparente green+transparent	<input checked="" type="checkbox"/> GG e gjelbër+e gjelbër green+green	<input checked="" type="checkbox"/> OR portokalli orange	<input checked="" type="checkbox"/> OT portokalli+transparente orange+transparent	<input checked="" type="checkbox"/> OO portokalli+portokalli orange+orange
<input checked="" type="checkbox"/> AT antracit anthracite	<input checked="" type="checkbox"/> AT antracit+transparente anthracite+transparent	<input checked="" type="checkbox"/> AA antracit+antracit anthracite+anthracite																				
<input checked="" type="checkbox"/> ES e argjendtë elox elox silver	<input checked="" type="checkbox"/> ST e argjendtë+transparente silver+transparent	<input checked="" type="checkbox"/> SS e argjendtë+e argjendtë silver+silver																				
<input checked="" type="checkbox"/> IW e bardhë filishi ivory white	<input checked="" type="checkbox"/> IT e fildishtë+transparente ivory+transparent	<input checked="" type="checkbox"/> II e fildishtë+e fildishtë ivory+ivory																				
<input checked="" type="checkbox"/> RD e kuqe red	<input checked="" type="checkbox"/> RT e kuqe+transparente red+transparent	<input checked="" type="checkbox"/> RR e kuqe+e kuqe red+red																				
<input checked="" type="checkbox"/> GR e gjelbër green	<input checked="" type="checkbox"/> GT e gjelbër+transparente green+transparent	<input checked="" type="checkbox"/> GG e gjelbër+e gjelbër green+green																				
<input checked="" type="checkbox"/> OR portokalli orange	<input checked="" type="checkbox"/> OT portokalli+transparente orange+transparent	<input checked="" type="checkbox"/> OO portokalli+portokalli orange+orange																				



PRIZË SCHUKO+KS 2P+E 16 A 250 V~ 2M

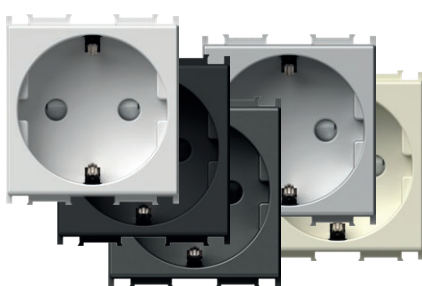

- VM10PW
- VM10SB
- VM10AT
- VM10ES
- VM10IW

- 2P+E schuko
- 16 A 250 V~, lloji VM10
- në përputhje me IEC 60884-1, CEE7
- kontaktet e vidave 1,5-2,5 mm²
- kontaktet me rrymën të mbuluara



SOCKET SCHUKO+KS 2P+E 16A 250V~ 2M

- 2P+E schuko
- 16A 250V~, type VM10
- in accordance with IEC 60884-1, CEE7
- screw contacts 1.5-2.5 mm²
- shuttered live contacts

PRIZË SCHUKO+KS 2P+E 16 A 250 V~ 2M

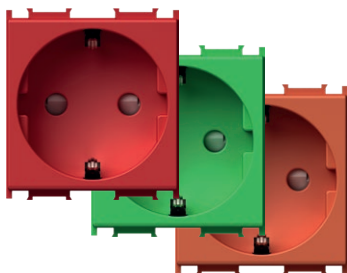

- VM10RD
- VM10GR
- VM10OR

- 2P+E schuko
- 16 A 250 V~, lloji VM10
- në përputhje me IEC 60884-1, CEE7
- kontaktet e vidave 1,5-2,5 mm²
- kontaktet me rrymën të mbuluara



SOCKET SCHUKO+KS 2P+E 16A 250V~ 2M

- 2P+E schuko
- 16A 250V~, type VM10
- in accordance with IEC 60884-1, CEE7
- screw contacts 1.5-2.5 mm²
- shuttered live contacts

PRIZË SCHUKO+KS+KAPAK 2P+E 16 A 250 V~ 2M

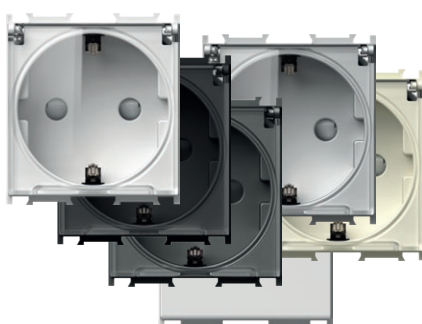

- VM11PT
- VM11BT
- VM11AT
- VM11ST
- VM11IT
- VM11PP

- 2P+E schuko+kapak
- 16 A 250 V~, lloji VM11
- në përputhje me IEC 60884-1, CEE7
- kontaktet e vidave 1,5-2,5 mm²
- kontaktet me rrymën të mbuluara



SOCKET SCHUKO+KS+COVER 2P+E 16A 250V~ 2M

- 2P+E schuko+cover
- 16A 250V~, type VM11
- in accordance with IEC 60884-1, CEE7
- screw contacts 1.5-2.5 mm²
- shuttered live contacts

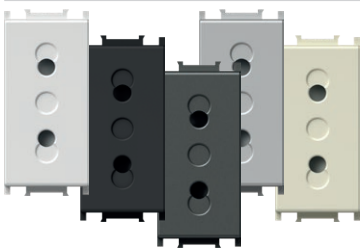

- VM20PW
- VM20SB
- VM20AT
- VM20ES
- VM20IW

PRIZË EURO+KS 2P 10A 250 V~ 1M

- 2P Euro
- 10A 250 V[~], Iloji VM20
- në përputhje me IEC 60884-1, CEE7
- kontaktet e vidave 1,5-2,5 mm²
- kontaktet me rrymën të mbuluara



SOCKET EURO+KS 2P 10A 250V~ 1M

- 2P Euro
- 10A 250V[~], type VM20
- in accordance with IEC 60884-1, CEE7
- screw contacts 1.5-2.5 mm²
- shuttered live contacts

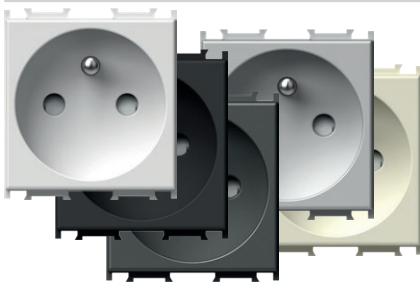

- VM40PW
- VM40SB
- VM40AT
- VM40ES
- VM40IW

PRIZË FRANCEZE+KS 2P+E 16 A 250 V~ 2M

- 2P+E Franceze
- 16 A 250 V[~], Iloji VM40
- në përputhje me IEC 60884-1, NF C 61-314, CEE7
- kontaktet e vidave 1,5-2,5 mm²
- kontaktet me rrymën të mbuluara



SOCKET FRENCH+KS 2P+E 16A 250V~ 2M

- 2P+E French
- 16A 250V[~], type VM40
- in accordance with IEC 60884-1, NF C 61-314, CEE7
- screw contacts 1.5-2.5 mm²
- shuttered live contacts

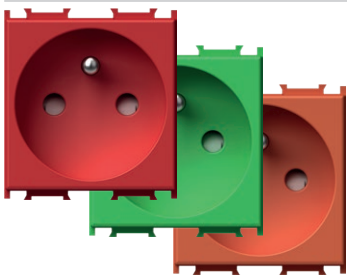

- VM40RD
- VM40GR
- VM40OR

PRIZË FRANCEZE+KS 2P+E 16 A 250 V~ 2M

- 2P+E Franceze
- 16 A 250 V[~], Iloji VM40
- në përputhje me IEC 60884-1, NF C 61-314, CEE7
- kontaktet e vidave 1,5-2,5 mm²
- kontaktet me rrymën të mbuluara



SOCKET FRENCH+KS 2P+E 16A 250V~ 2M

- 2P+E French
- 16A 250V[~], type VM40
- in accordance with IEC 60884-1, NF C 61-314, CEE7
- screw contacts 1.5-2.5 mm²
- shuttered live contacts



- VM41PT
- VM41BT
- VM41AT
- VM41ST
- VM41IT

PRIZË FRANCEZE+KS+KAPAK 2P+E 16 A 250 V~ 2M

- 2P+E Franceze+kapak
- 16 A 250 V[~], Iloji VM41
- në përputhje me IEC 60884-1, NF C 61-314, CEE7
- kontaktet e vidave 1,5-2,5 mm²
- kontaktet me rrymën të mbuluara



SOCKET FRENCH+KS+COVER

- 2P+E 16A 250V~ 2M
- 2P+E French+cover
- 16A 250V[~], type VM41
- in accordance with IEC 60884-1, NF C 61-314, CEE7
- screw contacts 1.5-2.5 mm²
- shuttered live contacts

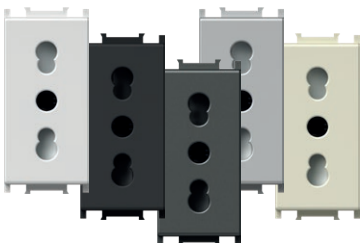

- VM30PW
- VM30SB
- VM30AT
- VM30ES
- VM30IW

PRIZË ITALIANE P17/11+KS 2P+E 16 A 250 V~ 1M

- 2P+E Italiane P17/11
- 16 A 250 V[~], Iloji VM30
- në përputhje me IEC 60884-1, CEI 23-50
- kontaktet e vidave 1,5-2,5 mm²
- kontaktet me rrymën të mbuluara



SOCKET ITALIAN P17/11+KS 2P+E 16A 250V~ 1M

- 2P+E Italian P17/11
- 16A 250V[~], type VM30
- in accordance with IEC 60884-1, CEI 23-50
- screw contacts 1.5-2.5 mm²
- shuttered live contacts

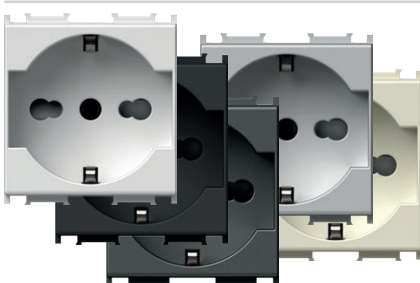

- VM31PW
- VM31SB
- VM31AT
- VM31ES
- VM31IW

PRIZË SCHUKO/ITALIANE P17/11+KS 2P+E 16 A 250 V~ 2M

- 2P+E Schuko/Italiane P17/11
- 16 A 250 V[~], Iloji VM31
- në përputhje me IEC 60884-1, CEI 23-50
- kontaktet e vidave 1,5-2,5 mm²
- kontaktet me rrymën të mbuluara

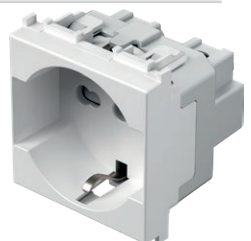

SOCKET SCHUKO/ITA P17/11+KS

- 2P+E 16A 250V~ 2M
- 2P+E schuko/Italian P17/11
- 16A 250V[~], type VM31
- in accordance with IEC 60884-1, CEI 23-50
- screw contacts 1.5-2.5 mm²
- shuttered live contacts

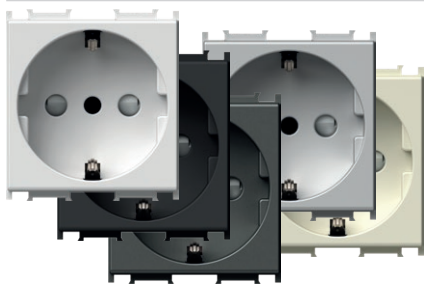

- VM32PW
- VM32SB
- VM32AT
- VM32ES
- VM32IW

PRIZË SCHUKO/ITALIANE P30+KS 2P+E 16 A 250 V~ 2M

- 2P+E Schuko/Italiane P30
- 16 A 250 V~, lloji VM32
- në përputhje me IEC 60884-1, CEI 23-50
- kontaktet e vidave 1,5-2,5 mm²
- kontaktet me rrymën të mbuluara

SOCKET SCHUKO/ITA P30+KS 2P+E 16A 250V~ 2M

- 2P+E schuko/Italian P30
- 16A 250V~, type VM32
- in accordance with IEC 60884-1, CEI 23-50
- screw contacts 1.5-2.5 mm²
- shuttered live contacts

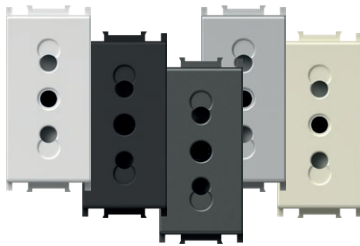

- VM33PW
- VM33SB
- VM33AT
- VM33ES
- VM33IW

PRIZË ITALIANE P11+KS 2P+E 10A 250 V~ 1M

- 2P+E Italiane P11
- 10A 250 V~, lloji VM33
- në përputhje me IEC 60884-1, CEI 23-50
- kontaktet e vidave 1,5-2,5 mm²
- kontaktet me rrymën të mbuluara

SOCKET ITALIAN P11+KS 2P+E 10A 250V~ 1M

- 2P+E Italian P11
- 10A 250V~, type VM33
- in accordance with IEC 60884-1, CEI 23-50
- screw contacts 1.5-2.5 mm²
- shuttered live contacts

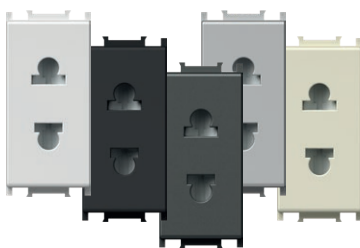

- VM21PW
- VM21SB
- VM21AT
- VM21ES
- VM21IW

PRIZË EURO/AMERIKANE+KS 2P 16A 250 V~ 1M

- 2P Euro/Amerikane
- 16 A 250 V~, lloji VM21
- kontaktet e vidave 1,5-2,5 mm²
- kontaktet me rrymën të mbuluara
- vetëm për vendet jashtë BE-së

SOCKET EURO/AMERICAN+KS 2P 16A 250V~ 1M

- 2P Euro/American
- 16A 250V~, type VM21
- screw contacts 1.5-2.5 mm²
- shuttered live contacts
- only for countries not members of EU

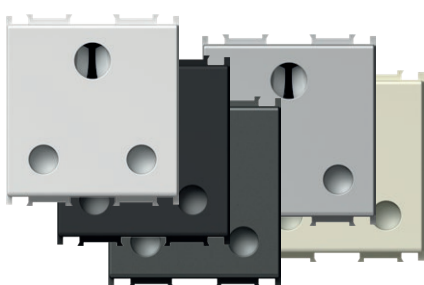

- VM51PW
- VM51SB
- VM51AT
- VM51ES
- VM51IW

PRIZË BRITANIKE BS 546+KS 2P+E 15 A 250 V~ 2M

- 2P+E Britanike BS 546
- 15 A 250 V~, lloji VM51
- në përputhje me BS 546
- kontaktet e vidave 1,5-4 mm²
- kontaktet me rrymën të mbuluara

SOCKET BRITISH BS 546+KS 2P+E 15A 250V~ 2M

- 2P+E British BS 546
- 15A 250V~, type VM51
- in accordance with BS 546
- screw contacts 1.5-4 mm²
- shuttered live contacts

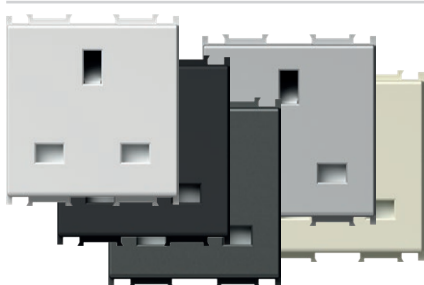

- VM52PW
- VM52SB
- VM52AT
- VM52ES
- VM52IW

PRIZË BRITANIKE BS 1363-2+KS 2P+E 13 A 250 V~ 2M

- 2P+E Britanike BS 1363-2
- 13 A 250 V~, lloji VM52
- në përputhje me BS 1363-2
- kontaktet e vidave 1,5-4 mm²
- kontaktet me rrymën të mbuluara

SOCKET BRITISH BS 1363-2+KS 2P+E 13A 250V~ 2M

- 2P+E British BS 1363-2
- 13A 250V~, type VM52
- in accordance with BS 1363-2
- screw contacts 1.5-4 mm²
- shuttered live contacts

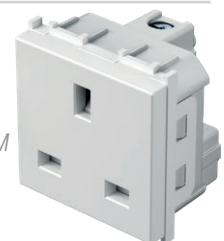

VM80

- lidhje paralele me prizën e parë në radhë
- mbrojtje e klasit III
- Uc=275 V ac, Uoc/Isc=6 kV/3 kA, Up<800 V
- në përputhje me IEC 61643-1
- telat 1,5 mm², IP20
- sinjalistik gjatë shkëputjes





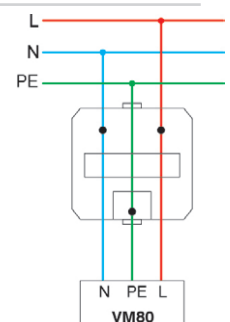







SURGE PROTECTOR MPE MINI 275V/50Hz

- parallel connection with the first socket in the row
- protection class III
- Uc=275Vac, Uoc/Isc=6kV/3kA, Up<800V
- in accordance with IEC 61643-1
- wires 1.5mm², IP20
- sound signal at breakdown









S O C K E T S V M

PËRSHTATJE E PRIZAVE DHE SPINAVE
 SOCKETS AND PLUGS MATCHING

PRIZA / SOCKET								
LLOJI I SPINËS / PLUG STYLE	VM10 VM11	VM20	VM30	VM33	VM31	VM32	VM40 VM41	VM21
Gjermane / German 	•				•	•		
Franceze / French 	•				•	•	•	
Italiane / Italian S11 			•	•	•	•		
Italiane / Italian S17 			•		•			
Euro 	•	•	•		•	•	•	•

PËRSHTATJE E PRIZAVE DHE SPINAVE
 SOCKETS AND PLUGS MATCHING

PRIZA / SOCKET			
LLOJI I SPINËS / PLUG STYLE	VM21	VM51	VM52
Amerikane / American 	•		
Britanike / British BS 546 		•	
Britanike / British BS 1363-2 			•

1M = 22,5 x 45
 2M = 45 x 45

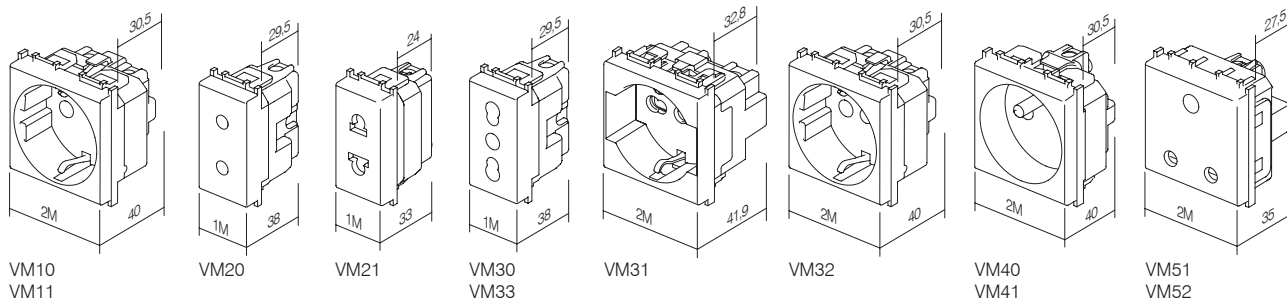



Iloji type	përshkrimi description	të dhënat teknike technical data	madhësia size	ngjyra colour
KM10	PRIZË TV BAZË SOCKET TV BASIC	0dB	1M	<input type="checkbox"/> PW e bardhë polare polar white
KM11	PRIZË TV ME KAPAK FUNDOR SOCKET TV END-LINE	1dB	1M	<input checked="" type="checkbox"/> SB e zezë soft touch soft touch black
KM12	PRIZË TV KALUESE SOCKET TV TROUGHPASS	10dB	1M	<input checked="" type="checkbox"/> AT antracit anthracite
⋮	⋮	⋮	⋮	<input type="checkbox"/> ES e argjendtë elox elox silver
⋮	⋮	⋮	⋮	<input type="checkbox"/> IW e bardhë fildishi ivory white

PRIZË TV BAZË 0dB 1M



- KM10PW
- KM10SB
- KM10AT
- KM10ES
- KM10IW

- TV bazë
- reduktim 0dB
- lidhje e pasme – F standarde
SOCKET TV BASIC 0dB 1M
- TV basic
- reduction 0dB
- back connector – F standard



PRIZË TV BAZË 0dB 2M

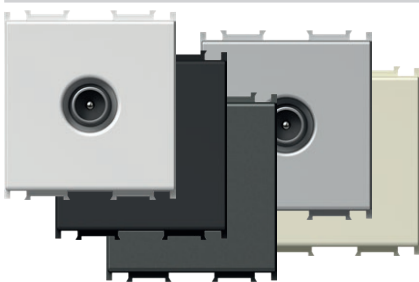

- KM20PW
- KM20SB
- KM20AT
- KM20ES
- KM20IW

- TV bazë
- reduktim 0dB
- lidhje e pasme – F standarde
SOCKET TV BASIC 0dB 2M
- TV basic
- reduction 0dB
- back connector – F standard



PRIZË TV ME KAPAK FUNDOR 1dB 1M



- KM11PW
- KM11SB
- KM11AT
- KM11ES
- KM11IW

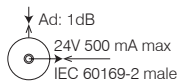

- TV me kapak fundor
- gama e frekuencës 5=2400 MHz
- reduktimi < 1 dB
- në përputhje me EN 50083-1
- kontaktet e vidave
SOCKET TV END-LINE 1dB 1M
- TV end-line
- frequency range 5=2400 MHz
- reduction < 1 dB
- in accordance with EN 50083-1
- screw contacts



PRIZË TV KALUESE 10dB 1M

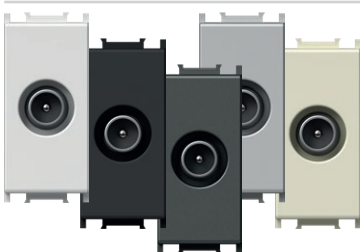

- KM12PW
- KM12SB
- KM12AT
- KM12ES
- KM12IW

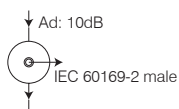

- TV kaluese
- gama e frekuencës 5=2400 MHz
- reduktimi < 10 dB
- në përputhje me EN 50083-1
- kontaktet e vidave
SOCKET TV TROUGHPASS 10dB 1M
- TV troughpass
- frequency range 5=2400 MHz
- reduction < 10 dB
- in accordance with EN 50083-1
- screw contacts



PRIZË SAT BAZË 0dB 1M



- KM15PW
- KM15SB
- KM15AT
- KM15ES
- KM15IW

- SAT bazë
- reduktim 0dB
- lidhje e pasme – F standarde
- SOCKET SAT BASIC 0dB 1M**
- SAT basic
- reduction 0dB
- back connector – F standard



PRIZË SAT BAZË 0dB 2M

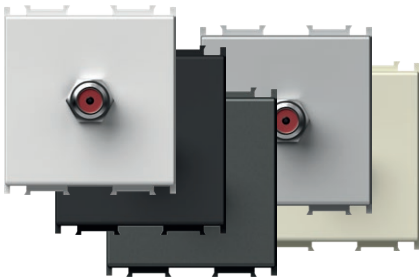

- KM24PW
- KM24SB
- KM24AT
- KM24ES
- KM24IW

- SAT bazë
- reduktim 0dB
- lidhje e pasme – F standarde
- SOCKET SAT BASIC 0dB 2M**
- SAT basic
- reduction 0dB
- back connector – F standard



PRIZË SAT ME KAPAK FUNDOR 1dB 1M

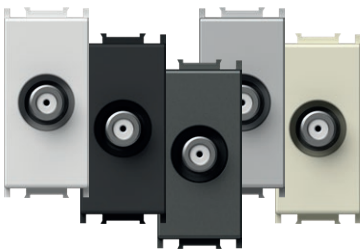

- KM16PW
- KM16SB
- KM16AT
- KM16ES
- KM16IW

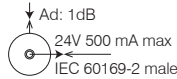

- SAT me kapak fundor
- gama e frekuencës 5÷2400 MHz
- reduktim < 0dB
- në përputhje me EN 50083-1
- kontaktet e vidave
- SOCKET SAT END-LINE 1dB 1M**
- SAT end-line
- frequency range 5÷2400 MHz
- reduction < 1dB
- in accordance with EN 50083-1
- screw contacts



PRIZË R BAZË 0dB 1M



- KM19PW
- KM19SB
- KM19AT
- KM19ES
- KM19IW

- R bazë
- reduktim 0dB
- lidhje e pasme – F standarde
- SOCKET R BASIC 0dB 1M**
- R basic
- reduction 0dB
- back connector – F standard



PRIZË R BAZË 0dB 2M

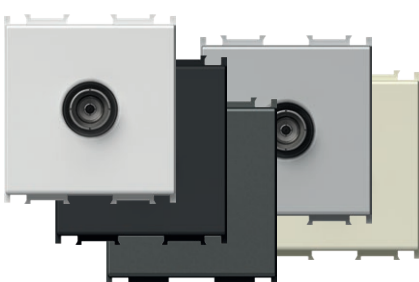

- KM29PW
- KM29SB
- KM29AT
- KM29ES
- KM29IW

- R bazë
- reduktim 0dB
- lidhje e pasme – F standarde
- SOCKET R BASIC 0dB 2M**
- R basic
- reduction 0dB
- back connector – F standard



PRIZË SAT-TV ME KAPAK FUNDOR 1dB 2M

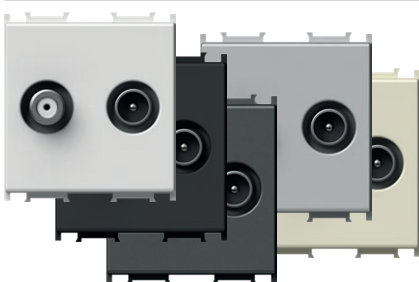

- KM25PW
- KM25SB
- KM25AT
- KM25ES
- KM25IW

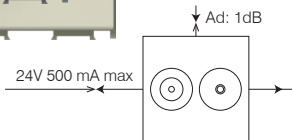

- SAT-TV me kapak fundor
- gama e frekuencës 5÷2400 MHz
- reduktim < 0dB
- në përputhje me EN 50083-1
- kontaktet e vidave
- SOCKET SAT-TV END-LINE 1dB 2M**
- SAT-TV end-line
- frequency range 5÷2400 MHz
- reduction < 1dB
- in accordance with EN 50083-1
- screw contacts



SHEMBUJ TË LIDHJEVE BAZË
BASIC CONNECTION SAMPLES

lidhje individuale
stand alone connection

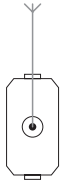

KM10
KM20
KM11
KM15
KM24
KM16
KM19
KM29
KM25

lidhje yll
star connection

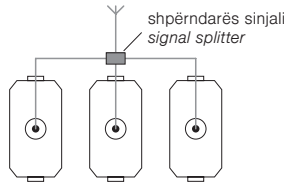

KM10
KM20
KM11
KM15
KM24
KM16
KM19
KM29
KM25

lidhje kaluese
throughpass connection

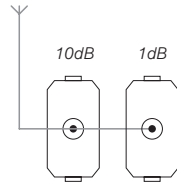

KM12 KM11

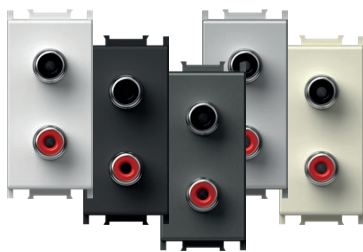

- KM22PW
- KM22SB
- KM22AT
- KM22ES
- KM22IW

PRIZË AUDIO 2xRCA 1M

- audio 2x RCA
- lidhje me ngjitje e kablos në pjesën e pasme

SOCKET AUDIO 2xRCA 1M

- audio 2x RCA
- soldering connection of cable at the back side



- KM23PW
- KM23SB
- KM23AT
- KM23ES
- KM23IW

PRIZË AUDIO ALTOPARLANTË 1M

- audio 2x Ø4mm
- për të mbajtur telin e altoparlantit, spinë banane Ø4mm ose pirun
- lidhje me ngjitje e kablos në pjesën e pasme

SOCKET AUDIO LOUDSPEAKERS 1M

- audio 2x Ø4mm
- to accommodate speaker wire, banana plug Ø4mm or spades
- soldering connection of cable at the back side



- KM26PW
- KM26SB
- KM26AT
- KM26ES
- KM26IW

PRIZË AUDIO ALTOPARLANTË 2M

- audio 2x Ø4mm
- për të mbajtur telin e altoparlantit, spinë banane Ø4mm ose pirun
- lidhje me ngjitje e kablos në pjesën e pasme

SOCKET AUDIO LOUDSPEAKERS 2M

- audio 2x Ø4mm
- to accommodate speaker wire, banana plug Ø4mm or spades
- soldering connection of cable at the back side

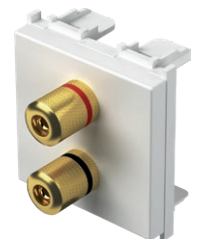

1M = 22,5 x 45
2M = 45 x 45

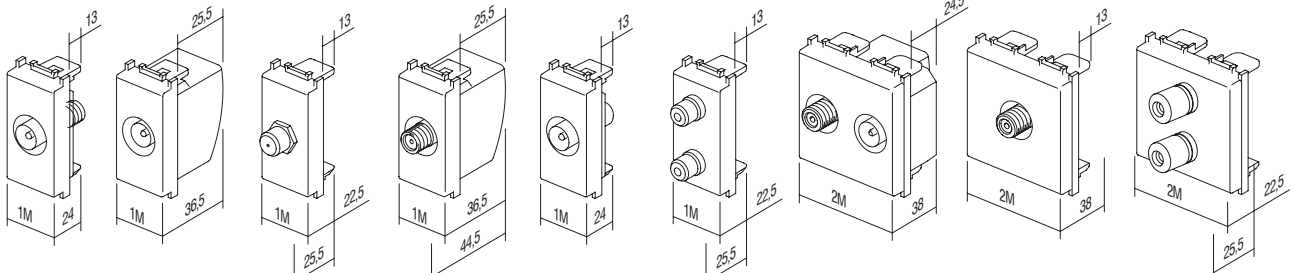

KM10

KM11
KM12

KM15

KM16

KM19

KM22
KM23

KM25

KM20
KM24
KM29

KM26

PRIZË TEL LT RJ11 6/4 1M



- KM30PW
- KM30SB
- KM30AT
- KM30ES
- KM30IW

- vidë TEL LT
- RJ11 6/4
- në përputhje me IEC 60603-7
- kontaktet e vidave

SOCKET TEL LT RJ11 6/4 1M

- TEL LT screw
- RJ11 6/4
- in accordance with IEC 60603-7
- screw contacts



PRIZË TEL BT SEC 6/6 1M

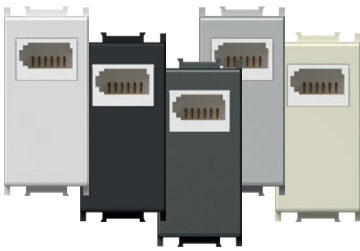

- KM31PW
- KM31SB
- KM31AT
- KM31ES
- KM31IW

- TEL BT Britanike standarde
- SEC dytësore 6/6
- në përputhje me BS 6312
- kontaktet e vidave

SOCKET TEL BT SEC 6/6 1M

- TEL BT British standard
- SEC secondary 6/6
- in accordance with BS 6312
- screw contacts



PRIZË TEL KS RJ11 6/4 1M

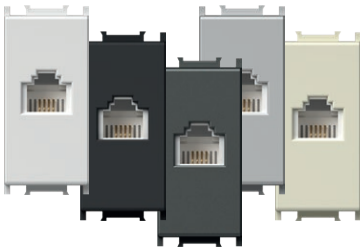

- KM36PW
- KM36SB
- KM36AT
- KM36ES
- KM36IW

- standard fiksues trapez KS
- RJ11 6/4
- në përputhje me IEC 60603-7

SOCKET TEL KS RJ11 6/4 1M

- KS keystone fixing standard
- RJ11 6/4
- in accordance with IEC 60603-7

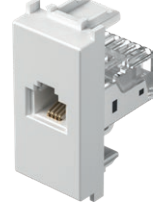

PRIZË CAT5e KS RJ45 8/8 1M

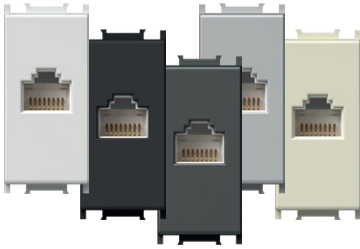

- KM37PW
- KM37SB
- KM37AT
- KM37ES
- KM37IW

- standard fiksues trapez KS
- CAT5e, RJ45 8/8
- në përputhje me IEC 60603-7

SOCKET CAT5e KS RJ45 8/8 1M

- KS keystone fixing standard
- CAT5e, RJ45 8/8
- in accordance with IEC 60603-7

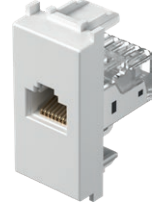

PËRSHTATËS KS 1M

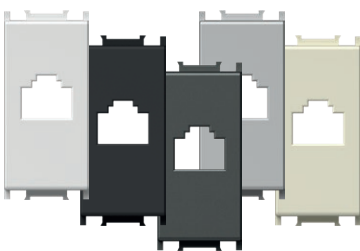

- KM35PW
- KM35SB
- KM35AT
- KM35ES
- KM35IW

- standard fiksues trapez KS
- AMP, Avaya, Brandrex, FMT, Mfico, Tyco, ...
- moduli i komunikimit nuk përfshihet

ADAPTER KS 1M

- KS keystone fixing standard
- AMP, Avaya, Brandrex, FMT, Mfico, Tyco, ...
- communication module not included



PËRSHTATËS KS ME MBROJTJE NGA PLUHURI 1M



- KM38PW
- KM38SB
- KM38AT
- KM38ES
- KM38IW

- standard fiksues trapez KS me mbrojtje nga pluhuri
- AMP, Avaya, Brandrex, FMT, Mfico, Tyco, ...
- moduli i komunikimit nuk përfshihet

ADAPTER KS WITH DUST PROTECTION 1M

- KS keystone fixing standard with dust protection
- AMP, Avaya, Brandrex, FMT, Mfico, Tyco, ...
- communication module not included



PRIZË CAT6 SCH KS RJ45 8/8 1M

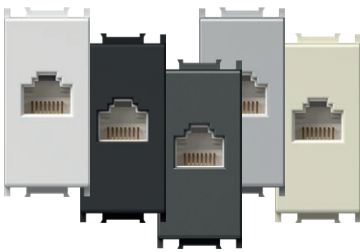

- KM39PW
- KM39SB
- KM39AT
- KM39ES
- KM39IW

- standard fiksues trapez KS
- CAT6 UTP pa vegla, RJ45 8/8
- në përputhje me ISO/IEC 11801

SOCKET CAT6 SCH KS RJ45 8/8 1M
 - KS keystone fixing standard
 - CAT6 UTP toolless, RJ45 8/8
 - in accordance with ISO/IEC 11801

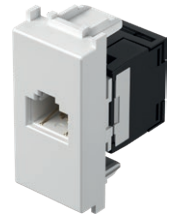

PËRSHTATËS KS UNIVERSAL 1M

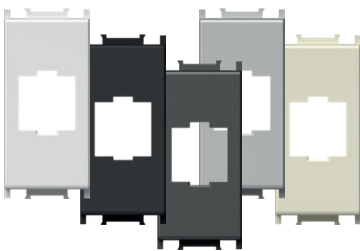

- KM50PW
- KM50SB
- KM50AT
- KM50ES
- KM50IW

- standard fiksues trapez KS
- i përshtatshëm për HDMI, USB
- moduli i komunikimit nuk përfshihet

ADAPTER KS UNIVERSAL 1M
 - KS keystone fixing standard
 - suitable for HDMI, USB
 - communication module not included

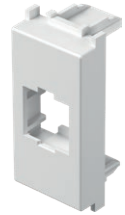

PËRSHTATËS PD 1M

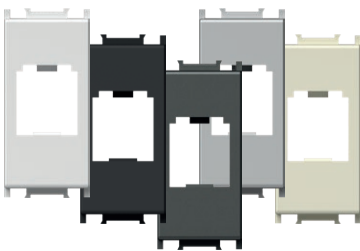

- KM40PW
- KM40SB
- KM40AT
- KM40ES
- KM40IW

- standard fiksues PD Panduit Mini-COM
- moduli i komunikimit nuk përfshihet

ADAPTER PD 1M
 - PD Panduit Mini-COM fixing standard
 - communication module not included



PËRSHTATËS PD ME MBROJTJE NGA PLUHURI 1M



- KM43PW
- KM43SB
- KM43AT
- KM43ES
- KM43IW

- standard fiksues PD Panduit Mini-COM me mbrojtje nga pluhuri
- moduli i komunikimit nuk përfshihet

ADAPTER PD WITH DUST PROTECTION 1M
 - PD Panduit Mini-COM fixing standard with dust protection
 - communication module not included



PËRSHTATËS R&M 1M

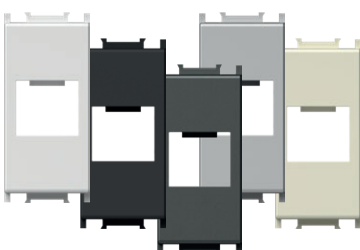

- KM46PW
- KM46SB
- KM46AT
- KM46ES
- KM46IW

- standard fiksues R&M
- moduli i komunikimit nuk përfshihet

ADAPTER R&M 1M
 - R&M fixing standard
 - communication module not included



PËRSHTATËS R&M CAT6A 1M

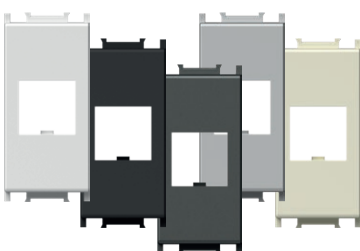

- KM52PW
- KM52SB
- KM52AT
- KM52ES
- KM52IW

- fiksues R&M për CAT6A
- moduli i komunikimit nuk përfshihet

ADAPTER R&M CAT6A 1M
 - R&M fixing for CAT6A
 - communication module not included





- KM47PW
- KM47SB
- KM47AT
- KM47ES
- KM47IW

PËRSHTATËS R&M ME MBROJTJE NGA PLUHURI 1M

- standard fiksues R&M me mbrojtje nga pluhuri
- moduli i komunikimit nuk përfshihet

ADAPTER R&M WITH DUST PROTECTION 1M

- R&M fixing standard with dust protection
- communication module not included



- KM53PW
- KM53SB
- KM53AT
- KM53ES
- KM53IW

PËRSHTATËS R&M CAT6A ME MBROJTJE NGA PLUHURI 1M

- fiksues R&M për CAT6A me mbrojtje nga pluhuri
- moduli i komunikimit nuk përfshihet

ADAPTER R&M CAT6A WITH DUST PROTECTION 1M

- R&M fixing for CAT6A with dust protection
- communication module not included



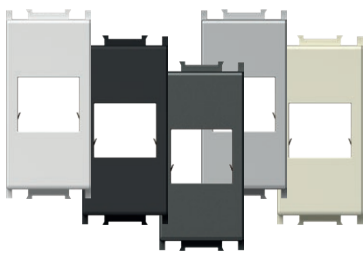

- KM45PW
- KM45SB
- KM45AT
- KM45ES
- KM45IW

PËRSHTATËS LK 1M

- standard fiksues LK LeoniKerpen eLine / BKS NewLine
- moduli i komunikimit nuk përfshihet

ADAPTER LK 1M

- LK LeoniKerpen eLine / BKS NewLine fixing standard
- communication module not included

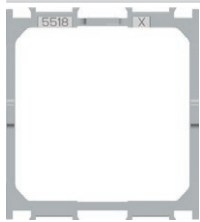

KA26

PËRSHTATËS NEXANS/SCHRACK 2M

- përshtatës fiksues për Nexans LANmark dhe LANmark në Schrack velikosti 45x45 mm
- modul Schrack 45x45 mm
- e përshtatshme për Schrack llojin HSEMD02W2F
- moduli i komunikimit nuk përfshihet

ADAPTER NEXANS/SCHRACK 2M

- fixing adapter for Nexans LANmark and Schrack module 45x45mm
- suitable for Nexans type N423.540N
- suitable for Schrack type HSEMD02W2F
- communication module not included

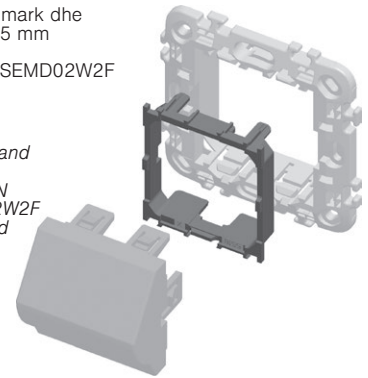

- KM48PW
- KM48SB
- KM48AT
- KM48ES
- KM48IW

PËRSHTATËS AT&T SYSTIMAX ME MBROJTJE NGA PLUHURI 1M

- standard fiksues AT&T Systimax me mbrojtje nga pluhuri
- moduli i komunikimit nuk përfshihet

ADAPTER AT&T SYSTIMAX WITH DUST PROTECTION 1M

- AT&T Systimax fixing standard with dust protection
- communication module not included



- KM51PW
- KM51SB
- KM51AT
- KM51ES
- KM51IW

PRIZË USB LLOJI A 1M

- prizë USB 2.0 lloji A
- kontaktet e vidave, raster 5 mm, 1,5 mm², 1x2P + 1x3P
- lidhjet elektrike:
 - KUNJI 1 - VCC (+5V, teli i kuq)
 - KUNJI 2 - Të dhëna - (teli i bardhë)
 - KUNJI 3 - Të dhëna + (teli i gjelbër)
 - KUNJI 4 - GND - tokëzimi (teli i zi)
 - S - mbrojtja
- në përputhje me direktivën 2011/95/EU (RoHS2)

SOCKET USB TYPE A 1M

- USB 2.0 socket type A
- screw contacts, raster 5 mm, 1,5 mm², 1x2P + 1x3P
- wiring:
 - PIN 1 - VCC (+5V, red wire)
 - PIN 2 - Data - (white wire)
 - PIN 3 - Data + (green wire)
 - PIN 4 - GND - ground (black wire)
 - S - shield
- in accordance with directive 2011/95/EU (RoHS2)



1M = 22,5 x 45
2M = 45 x 45

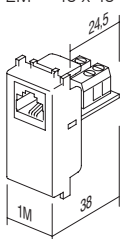

KM30

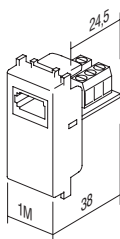

KM31

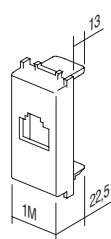

KM35
KM38
KM48

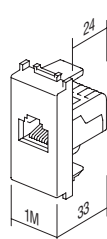

KM36
KM37
KM39

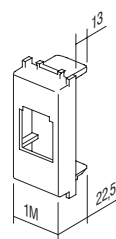

KM40
KM43

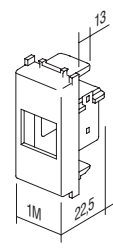

KM45

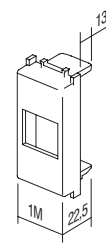

KM46
KM47
KM50
KM52
KM53

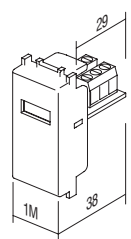

KM51

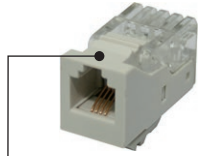

KA10

Iloji type	përshkrimi description	të dhënat teknike technical data
KA10	KONEKTORI KS CAT3 CONNECTOR KS CAT3	RJ11 6/4
KA11	KONEKTORI KS CAT5e CONNECTOR KS CAT5e	RJ45 8/8
KA12	KONEKTORI KS CAT5eS CONNECTOR KS CAT5eS	RJ45 8/8
⋮	⋮	⋮
⋮	⋮	⋮



KA10

KONEKTORI KS CAT3 RJ11 6/4

- standard fiksues trapez KS
- CAT3, RJ11 6/4
- në përputhje me IEC 60603-7

CONNECTOR KS CAT3 RJ11 6/4

- KS keystone fixing standard
- CAT3, RJ11 6/4
- in accordance with IEC 60603-7



KA11

KONEKTORI KS CAT5e RJ45 8/8

- standard fiksues trapez KS
- CAT5e, RJ45 8/8
- në përputhje me IEC 60603-7

CONNECTOR KS CAT5e RJ45 8/8

- KS keystone fixing standard
- CAT5e, RJ45 8/8
- in accordance with IEC 60603-7



KA12

KONEKTORI KS CAT5eS RJ45 8/8

- standard fiksues trapez KS
- CAT5eS, RJ45 8/8
- në përputhje me IEC 60603-7

CONNECTOR KS CAT5eS RJ45 8/8

- KS keystone fixing standard
- CAT5eS, RJ45 8/8
- in accordance with IEC 60603-7



KA15

KONEKTORI KS CAT6 SCH RJ45 8/8

- standard fiksues trapez KS
- CAT6 UTP pa vegla, RJ45 8/8
- në përputhje me ISO/IEC 11801

CONNECTOR KS CAT6 SCH RJ45 8/8

- KS keystone fixing standard
- CAT6 UTP toolless, RJ45 8/8
- in accordance with ISO/IEC 11801



KA16

KONEKTORI KS CAT6S SCH RJ45 8/8

- standard fiksues trapez KS
- CAT6S STP pa vegla, RJ45 8/8
- në përputhje me ISO/IEC 11801

CONNECTOR KS CAT6S SCH RJ45 8/8

- KS keystone fixing standard
- CAT6S STP toolless, RJ45 8/8
- in accordance with ISO/IEC 11801



KA17

KONEKTORI KS CAT6a SCH RJ45 8/8

- standard fiksues trapez KS
- CAT6a STP pa vegla, RJ45 8/8
- në përputhje me ISO/IEC 11801

CONNECTOR KS CAT6a SCH RJ45 8/8

- KS keystone fixing standard
- CAT6a STP toolless, RJ45 8/8
- in accordance with ISO/IEC 11801



KA18

KONEKTORI SLIM KS CAT6S SCH RJ45 8/8

- standard fiksues trapez KS
- stil slim
- CAT6S STP pa vegla, RJ45 8/8
- në përputhje me ISO/IEC 11801
- i përshtatshëm edhe për përshtatës dysh KE46

CONNECTOR SLIM KS CAT6S SCH RJ45 8/8

- KS keystone fixing standard
- slim style
- CAT6S STP toolless, RJ45 8/8
- in accordance with ISO/IEC 11801
- suitable also for KE46 double adapter



KA27

KONEKTORI KS HDMI

- standard fiksues trapez KS
- vetëm në kombinim me përshtatësin KM50
- HDMI/HDMI

CONNECTOR KS HDMI

- KS keystone fixing standard
- only in combination with adapter KM50
- HDMI/HDMI



KA28

KABLLOJA KS HDMI

- standard fiksues trapez KS
- vetëm në kombinim me përshtatësin KM50
- HDMI/HDMI

CABLE KS HDMI

- KS keystone fixing standard
- only in combination with adapter KM50
- HDMI/HDMI



EM31



PW



Iloji type	përshkrimi description	të dhënat teknike technical data	madhësia size	ngjyra colour
EM10	REOSTAT RROTULLUES <i>DIMMER ROTATIVE</i>	R 300W	1M	<input type="checkbox"/> PW e bardhë polare <i>polar white</i>
EM12	REOSTAT RROTULLUES ME 2 DREJTJIME <i>DIMMER ROTATIVE 2WAY</i>	RL 300W	1M	<input checked="" type="checkbox"/> SB e zezë soft touch <i>soft touch black</i>
EM23	REOSTAT ME MONTIM NË KUTI <i>DIMMER INBOX</i>	RC,RL 200VA	/	<input checked="" type="checkbox"/> AT antracit <i>anthracite</i>
·	·	·	·	<input type="checkbox"/> ES e argjendtë elox <i>elox silver</i>
·	·	·	·	<input type="checkbox"/> IW e bardhë fildishi <i>ivory white</i>
·	·	·	·	<input type="checkbox"/> BL blu <i>blue</i>
·	·	·	·	<input type="checkbox"/> RD e kuqe <i>red</i>
·	·	·	·	<input type="checkbox"/> GR e gjelbër <i>green</i>
·	·	·	·	<input type="checkbox"/> OR portokalli <i>orange</i>
·	·	·	·	<input type="checkbox"/> RG e kuqe/e gjelbër <i>red/green</i>

REOSTAT RROTULLUES R 300W 1M



- EM10PW
- EM10SB
- EM10AT
- EM10ES
- EM10IW

- kontroll rrotullues pa çelës
- lloji RTS34, 43 RVP, ngarkesa R, 40W - 300W
- tensioni i furnizimit, 230 V ~ 50 Hz
- nuk është i mundur kombinimi i çelësit me 2 drejtime
- nuk lejohet kombinimi i më shumë reostatëve
- në përputhje me EN 60669-1
- kontaktet e vidave 1,5-2,5 mm²
- Treguesi LED

DIMMER ROTATIVE R 300W 1M

- rotation control without switch
- type RTS34, 43 RVP, load R, 40W - 300W
- supply voltage 230V ~ 50Hz
- 2-way switch combination is not possible
- more dimmers combination is not allowed
- in accordance with EN 60669-1
- screw contacts 1.5-2.5mm²
- LED indication



REOSTAT RROTULLUES/2 DREJTJIME RL 300W 1M



- EM12PW
- EM12SB
- EM12AT
- EM12ES
- EM12IW

- kontroll i rrotullimit me çelësin me 2 drejtime
- RL i ngarkesës, 40 W - 300 W
- tensioni i furnizimit, 230 V ~ 50 Hz
- është i mundur kombinimi i çelësit me 2 drejtime
- instalimi i disa njësjive bashkë në një kuti lejohet vetëm nëse ngarkesa maksimale totale e tyre nuk tejkalon fuqinë maksimale të një reostati të vetëm
- një qark lejon përdorimin e vetëm një reostati
- nuk ka siguresë të integruar - duhet të përdoret siguresa e jashtme
- në përputhje me EN 60669-1
- kontaktet e vidave 1,5-2,5 mm²
- treguesi i integruar LED i nivelit të ndriçimit

DIMMER ROTATIVE/2WAY RL 300W 1M

- rotation control with 2-way switch
- load RL, 40W - 300W
- supply voltage 230V ~ 50Hz
- 2-way switch combination is possible
- installing several devices together in one box is only permitted if their total maximum load does not exceed the maximum power of a single dimmer
- one circuit allows the use of only one dimmer
- no built-in fuse - external fuse must be used
- in accordance with EN 60669-1
- screw contacts - 1.5-2.5mm²
- integrated LED indication of dimming level

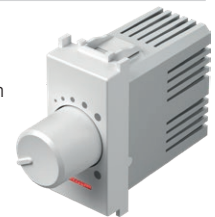



- EM13PW
- EM13SB
- EM13AT
- EM13ES
- EM13IW

REOSTAT RROTULLUES/2 DREJTIME LED 60W 1M

- kontroll i rrotullimit me çelësin me 2 drejtime
- ngarkesat: LED, 0 – 60W (maks. 6 llamba LED me ulje ndriçimi)
- GLS, 0 – 60 W
- tensioni i furnizimit, 230 V ~ 50 Hz
- është i mundur kombinimi i çelësit me 2 drejtime
- instalimi i disa njësjive bashkë në një kuti lejohet vetëm nëse ngarkesa maksimale totale e tyre nuk tejkalon fuqinë maksimale të një reostatit të vetëm
- një qark lejon përdorimin e vetëm një dimeri
- nuk ka siguresë të integruar - duhet të përdoret siguresa e jashtme
- në përputhje me EN-2-1
- kontaktet e vidave 1,5-2,5 mm²



DIMMER ROTATIVE/2WAY LED 60W 1M

- rotation control with 2-way switch
- loads: LED, 0 – 60W (max. 6 dimmable LED lamps)
- GLS, 0 – 60W
- supply voltage 230V ~ 50Hz
- 2-way switch combination is possible
- installing several devices together in one box is only permitted if their total maximum load does not exceed the maximum power of a single dimmer
- one circuit allows the use of only one dimmer
- no built-in fuse – external fuse must be used
- in accordance with IEC60669-2-1
- screw contacts - 1.5-2.5mm²

REOSTAT RROTULLUES/2 DREJTIME LED 180W 1M



- EM14PW
- EM14SB
- EM14AT
- EM14ES
- EM14IW

- kontroll i rrotullimit me çelësin me 2 drejtime
- ngarkesat: LED, 0 – 180 W (maks. 20 llamba LED me ulje ndriçimi)
- GLS, 0 – 180 W
- tensioni i furnizimit, 230 V ~ 50 Hz
- është i mundur kombinimi i çelësit me 2 drejtime
- instalimi i disa njësjive bashkë në një kuti lejohet vetëm nëse ngarkesa maksimale totale e tyre nuk tejkalon fuqinë maksimale të një reostatit të vetëm
- një qark lejon përdorimin e vetëm një dimeri
- nuk ka siguresë të integruar - duhet të përdoret siguresa e jashtme
- në përputhje me EN-2-1
- kontaktet e vidave 1,5-2,5 mm²

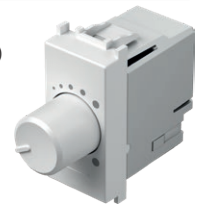

DIMMER ROTATIVE/2WAY LED 180W 1M

- rotation control with 2-way switch
- loads: LED, 0 – 180W (max. 20 dimmable LED lamps)
- GLS, 0 – 180W
- supply voltage 230V ~ 50Hz
- 2-way switch combination is possible
- installing several devices together in one box is only permitted if their total maximum load does not exceed the maximum power of a single dimmer
- one circuit allows the use of only one dimmer
- no built-in fuse – external fuse must be used
- in accordance with IEC60669-2-1
- screw contacts - 1.5-2.5mm²

REOSTAT RROTULLUES R 250W 1M



- EM15PW
- EM15SB
- EM15AT
- EM15ES
- EM15IW

- kontroll rrotullues pa çelës
- lloji RTS34, 43 RVP, ngarkesa R, 40W - 250W
- tensioni i furnizimit, 230 V ~ 50 Hz
- nuk është i mundur kombinimi i çelësit me 2 drejtime
- nuk lejohet kombinim i më shumë reostateve
- në përputhje me EN 60669-1
- kontaktet e vidave 1,5-2,5 mm²
- Treguesi LED

DIMMER ROTATIVE R 250W 1M

- rotation control without switch
- type RTS34, 43 RVP, load R, 40W - 250W
- supply voltage 230V ~ 50Hz
- 2-way switch combination is not possible
- more dimmers combination is not allowed
- in accordance with EN 60669-1
- screw contacts 1.5-2.5mm²
- LED indication

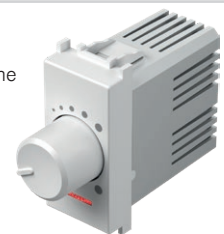



EM23

REOSTAT ME MONTIM NË KUTI R (250 W), (RC, RL 200 VA)

- montim në kuti, me kontroll me buton të jashtëm me shtypje
- RLC me ngarkesë 15-250 W ose 15-200 VA
- tensioni i furnizimit, 230 V ~ 50 Hz
- janë të mundura disa kombinime të butonave me shtypje
- nuk lejohet kombinim i më shumë reostateve
- memorizim i intensitetit të dritës
- funksion ndezje/ndalim i butë
- »leading edge«
- në përputhje me EN60669, EN60950, EN 61000, ETSI EN 300 220-1, ETSI EN 300 220-2
- kontaktet e vidave me tela 2,5 mm²

DIMMER INBOX R (250 W), (RC, RL 200 VA)

- inbox, controlled by external push button
- load RLC 15-250W or 15-200 VA
- supply voltage 230V~ 50HZ
- several push-buttons combinations are possible
- more dimmers combination is not allowed
- light intensity memory
- soft start/stop function
- »leading edge«
- in accordance with EN60669, EN60950, EN 61000, ETSI EN 300 220-1, ETSI EN 300 220-2
- screw contacts to wires 2,5 mm²



EM18

REOSTAT ME MONTIM NË KUTI LED 250 W

- montim në kuti, me kontroll me buton të jashtëm me shtypje
- për anën e përparme ose fundore
- tensioni i furnizimit, 230 V ~ 50 Hz
- janë të mundura disa kombinime të butonave me shtypje
- memorizim i intensitetit të dritës
- funksioni i ndezjes/ndalimit të butë
- kontrolli i intensitetit minimal
- vetëm një reostat për kuti muri
- vetëm për përdorim të brendshëm
- në përputhje me standardet EN 60669-1 dhe EN 60669-2-1

DIMMER INBOX LED 250W

- inbox, controlled by external push button
- for leading or trailing edge
- supply voltage 230V~ 50Hz
- several push-buttons combinations is possible
- light intensity memory
- soft start / stop function
- minimum intensity control
- only one dimmer per wall box
- only for indoor usage
- in accordance with EN 60669-1 and EN 60669-2-1



EM19

REOSTAT ME MONTIM NË KUTI DC LED 96 W

- montim në kuti, me kontroll me buton të jashtëm me shtypje
- për përdorim me drajverë për LED me tension konstant dhe disa drajverë për LED me rrymë konstante, 9-48 V DC, maks. 96 W (edhe për shiritat LED)
- jo për përdorim me ngarkesa me induksion
- janë të mundura kombinime të disa butonave me shtypje dhe disa reostateve
- memorizim i intensitetit të dritës
- funksioni i ndezjes/ndalimit të butë
- vetëm një reostat për kuti muri
- vetëm për përdorim të brendshëm

DIMMER INBOX DC LED 96W

- inbox, controlled by external push button
- for use with constant voltage LED drivers and some constant current LED drivers, 9-48V DC, max 96W (also for LED strips)
- not for use with inductive loads
- several push-buttons combinations and several dimmers is possible
- light intensity memory
- soft start / stop function
- only one dimmer per wall box
- only for indoor usage

EM10 (40÷300W)
EM15 (40÷300W)

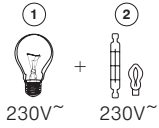

EM12 (40÷300W)

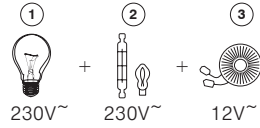

EM13 (0÷60W), EM14 (0÷180W),
EM23 (15÷250W, 15÷200VA),
EM18 (2÷250VA (3=10÷250VA), 2÷250W)

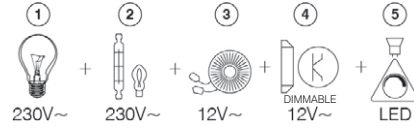

- 1 - llambë inkandeshente / incandescent lamp
- 2 - llambë halogjene / halogen lamp
- 3 - transformator klasik / classical transformer
- 4 - transformator elektrik me dimer / dimmable electronic transformer
- 5 - llambë LED me ulje ndriçimi / dimmable LED lamp

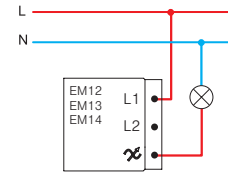
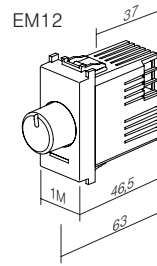
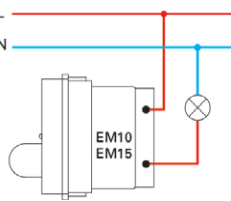
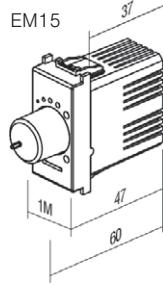
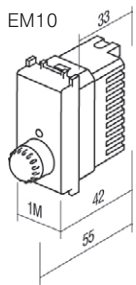

EM23

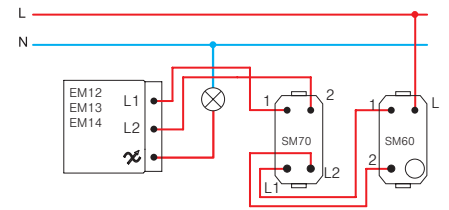
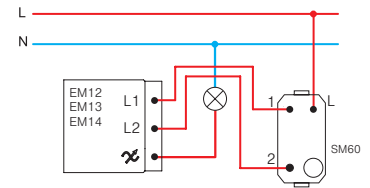
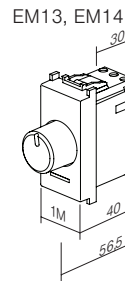
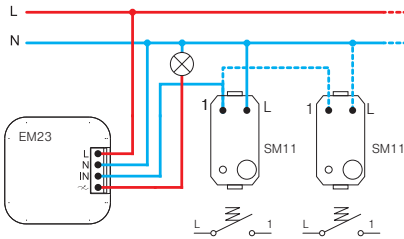
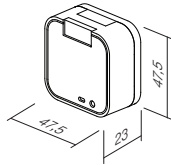

EM18

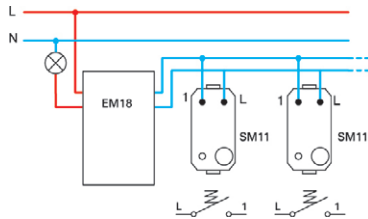
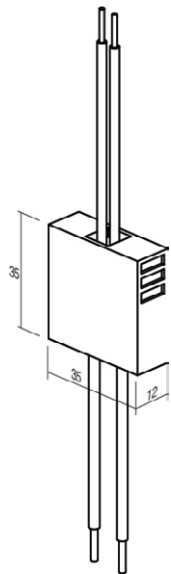

EM19

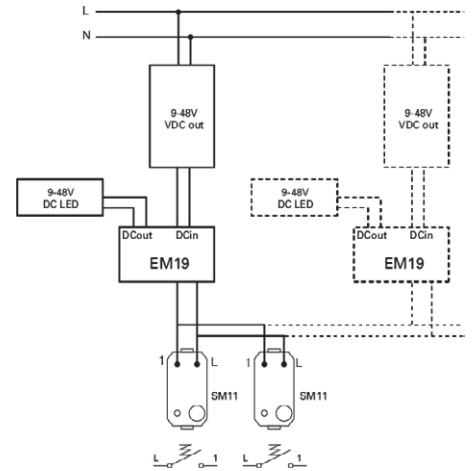
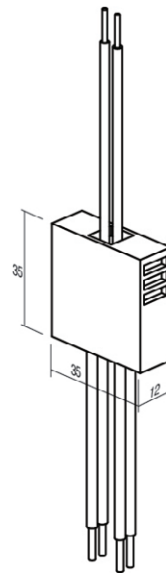

KUJDES!

Nëse lidhen më shumë reostatë në një kuti, reduktoni fuqinë e përbashkët me 10% për secilin reostat.

ATTENTION!

If more dimmers are connected in one box reduce maximum common power for 10% for each dimmer.

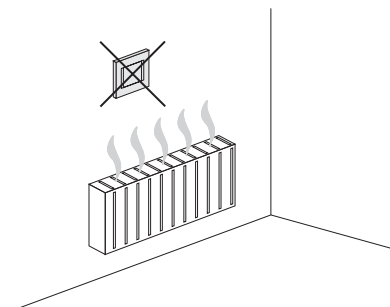

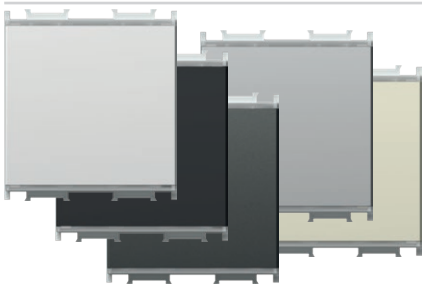

- EM25PW
- EM25SB
- EM25AT
- EM25ES
- EM25IW

ÇELËS / REOSTAT UNIVERSAL RLC 0-300W 2M

- reostat universal elektronik për NDEZJE/FIKJE dhe ulje ndriçimi të të gjitha llambave me ulje ndriçimi (klasike, halogjene, LED, CFL, ...) dhe disa llambave pa ulje ndriçimi
- zbulim automatik i llojit të llambës dhe rregullimit të regjimit të funksionimit
- reduktim i konsumit të energjisë
- funksioni i ndezjes së butë zgjat jetëgjatësinë e llambave
- kontrolluar me mikro çelësa të integruar
- funksioni i memorizimit i përfshirë – memorizon ndriçimin në ndezje
- mund të lidhen deri në pesë (5) njësi kontrolli shtesë EM26
- nuk është e mundur lidhja me çelës me 2 drejtime
- qark i shkurtër i integruar, mbrojtje nga mbingarkesa dhe mbinxehja
- tensioni i furnizimit, 230 V ~ 50 Hz
- ndriçim elegant LED, ngjyra dhe ndriçim i rregullueshëm
- është i mundur zëvendësimi i çelësit klasik në lidhjen me dy tela (1)
- funksionimi i plotë arrihet në lidhjen me tre tela (2)
- në përputhje me standardet EN 60669-1 dhe EN 60669-2-1
- kontaktet e vidave 1,5mm² (forca maks. e shtrëngimit 0,4 Nm)

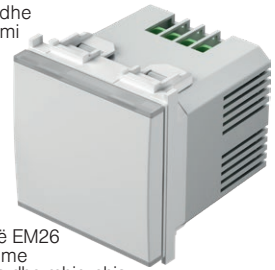

TOUCH EM25 është një reostat elektronik ndriçimi i kontrolluar me mikroprocesor. Ai shërben si çelës dhe reostat për llambat me ulje ndriçimi dhe disa llamba pa ulje ndriçimi. Mikroprocesori i integruar identifikon automatikisht llojin e llambës dhe rregullon regjimin e funksionimit. Ai memorizon nivelin e uljes së ndriçimit pas fikjes falë funksionit të integruar të memorizimit. Funksioni i ndezjes së butë zgjat jetëgjatësinë e llambës. Në buton ndriçimi i integruar elegant LED mundëson ngjyra të ndryshme dhe nivele intensiteti. Ndonjëherë mund të lidheni me deri në 5 çelësa kontrolli shtesë EM26 ("slave") në EM 25.

TOUCH EM25 is microprocessor controlled electronic light dimmer. It serves as switch and dimmer for dimmable and some of non-dimmable lamps. Integrated microprocessor automatically identifies the type of lamp and adjusts the operating mode. It remembers the level of dimming after switching off due to integrated memory function. Soft-start function extends the lamp service life. In button integrated elegant LED illumination enables many different colors and intensity levels. Optionally one can connect up to 5 additional control tasters EM26 («slave»).

SWITCH / DIMMER UNIVERSAL RLC 0-300W 2M

- universal electronic dimmer for ON/OFF switching and dimming of all dimmable lamps (classical, halogen, LED, CFL, ...) and some non-dimmable lamps
- automatic detection of lamp type and adjustment of operating mode
- reduction of energy consumption
- soft start function extends life of lamps
- controlled by build-in micro switches
- memory function included – memorizes brightness on turn-off
- up to five (5) additional control units EM26 can be connected
- connection with 2-way switch is not possible
- build-in short-circuit, overheating and overload protection
- supply voltage 230V ~ 50Hz
- elegant LED illumination, adjustable colour and brightness
- replacement of classical switch is possible at two-wire connection⁽¹⁾
- full functionality is achieved at three-wire connection⁽²⁾
- in accordance with EN 60669-1 and EN 60669-2-1
- screw contacts 1.5mm² (max. tightening torque 0.4Nm)

(1) lidhje me dy tela
two-wire connection

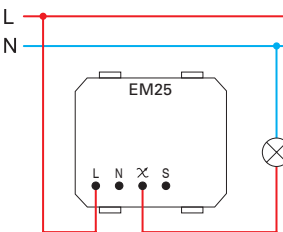

- lidhja me dy tela lejon uljen e ndriçimit të llambave me ulje ndriçimi

- two-wire connection allows dimming of dimmable lamps

(2) lidhje me tre tela
three-wire connection

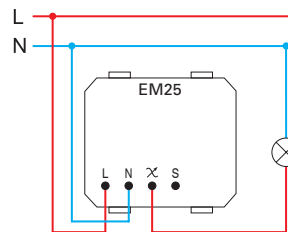

- lidhja me tre tela lejon uljen e ndriçimit të llambave me ulje ndriçimi dhe disa pa ulje ndriçimi dhe llambave CFL

- three-wire connection allows dimming of dimmable lamps and some of non-dimmable LED and CFL lamps

	1	2	5	6	7
Min.	40 W	40 W	40 VA	40 VA	40 VA
Max.	300 W	300 W	300 VA	100 VA	100 VA
	(F)	(F)	(F)		

- 1 - llambë inkandeshente / incandescent lamp
- 2 - llambë halogjene / halogen lamp
- 4 - transformator elektrik me dimer / dimmable electronic transformer
- 5 - transformator klasik / classical transformer

	1	2	4	6	7	8	9
Min.	0 W	0 W	0 VA	0 VA	0 VA	0 VA	0 VA
Max.	300 W	300 W	120 VA	120 VA	120 VA	120 VA	120 VA
	(F)	(F)	(F)			(F)	(F)

- 6 - llambë CLF me ulje ndriçimi me kursim energjie / dimmable energy saving CFL lamp
- 7 - llambë LED me ulje ndriçimi / dimmable LED lamp
- 8 - llambë CLF pa ulje ndriçimi me kursim energjie / non-dimmable energy saving CFL lamp
- 9 - llambë LED pa ulje ndriçimi / non-dimmable LED lamp

shënime /
remarks

- (F) filter EM27
- rekomandohet të përdoret filteri EM27 /
it is recommended to use filter EM27
- të gjitha llambat e kontrolluara duhet të jenë të njëjta /
all controlled lamps must be the same
- tabela e ngarkesave është e vlefshme për llambat me faktor fuqie PF>0.5 /
table of loads is valid for lamps with power factor PF>0.5

ndezje/fikje dhe ulje e ndriçimit të llambës /
on / off swithcing and dimming of lamp

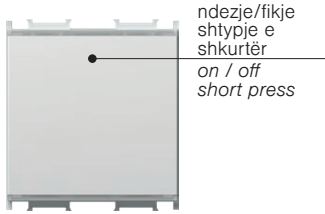

ndezje/fikje
shtypje e
shkurtër
on / off
short press



ngritje e
ndriçimit
shtypje e gjatë
dimming up
long press

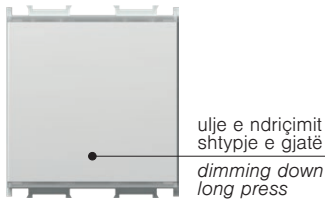

ulje e ndriçimit
shtypje e gjatë
dimming down
long press

përzgjedhja e ngjyrave LED dhe rregullimi i nivelit të intensitetit /
LED colour selection and intensity level adjustment

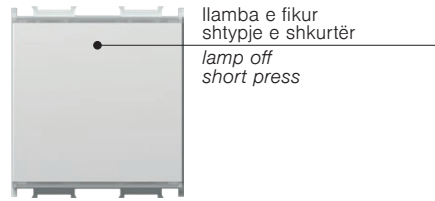

llamba e fikur
shtypje e shkurtër
lamp off
short press

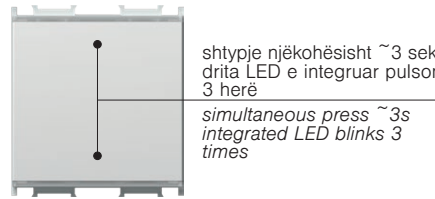

shtypje njëkohësisht ~3 sek.
drita LED e integruar pulson
3 herë
simultaneous press ~3s
integrated LED blinks 3
times

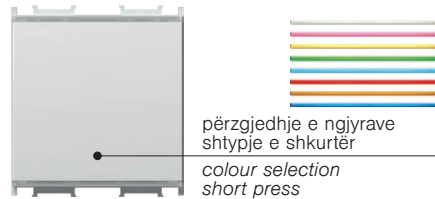

përzgjedhje e ngjyrave
shtypje e shkurtër
colour selection
short press

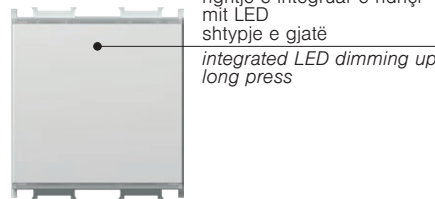

ngritje e integruar e ndriçimit
LED
shtypje e gjatë
integrated LED dimming up
long press

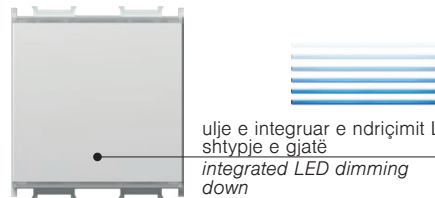

ulje e integruar e ndriçimit LED
shtypje e gjatë
integrated LED dimming
down
long press

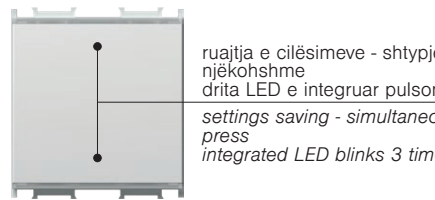

ruajtja e cilësimeve - shtypje e shkurtër e
njëkohshme
drita LED e integruar pulson 3 herë
settings saving - simultaneous short
press
integrated LED blinks 3 times

*funksion "RESET"/
"RESET" function

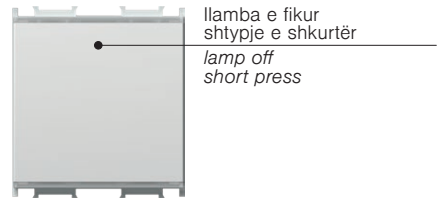

llamba e fikur
shtypje e shkurtër
lamp off
short press

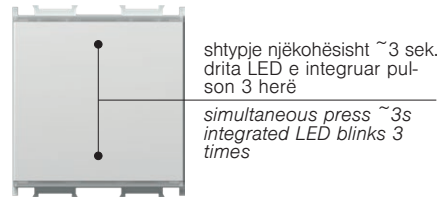

shtypje njëkohësisht ~3 sek.
drita LED e integruar pulson
3 herë
simultaneous press ~3s
integrated LED blinks 3
times

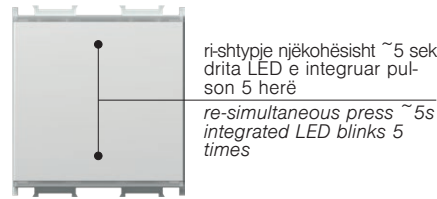

ri-shtypje njëkohësisht ~5 sek.
drita LED e integruar pulson
5 herë
re-simultaneous press ~5s
integrated LED blinks 5
times

- * - rekomandohet në instalimin e reostatit dhe ndërrimin e llambës
- e detyrueshme kur përdoren llamba pa ulje ndriçimi
- funksioni "RESET" nuk është i mundur kur përdoret lidhje me dy tela
- i mundur vetëm në EM25
- it is recommended at dimmer installation and lamp replacement
- mandatory when using non-dimmable lamps
- "RESET" function is not possible when using two-wire connection
- only possible on EM25

masat paraprake të instalimit /
installation precautions

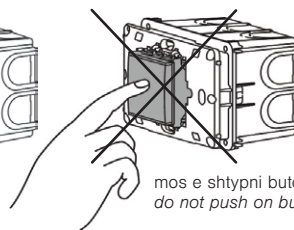
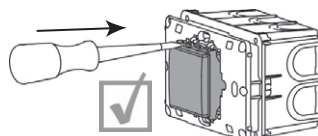
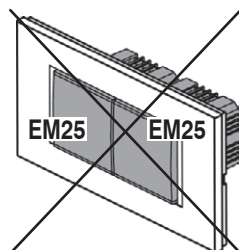
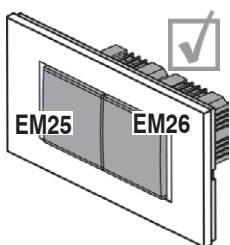

mos e shtypni butonin gjatë montimit /
do not push on button during mounting



- EM26PW
- EM26SB
- EM26AT
- EM26ES
- EM26IW

NJËSI KONTROLLI ME BUTON ME SHËTYPJE 2M

- e lidhur me reostatit universal EM25 lejon kontrollimin e llambave me të njëjtin funksionim (deri) si EM25
- tensioni i furnizimit, 230 V ~ 50 Hz
- në përputhje me standardet EN 60669-1 dhe EN 60669-2-1
- kontaktet e vidave 1,5 mm² (maks. e shtrëngimit 0,4 Nm)

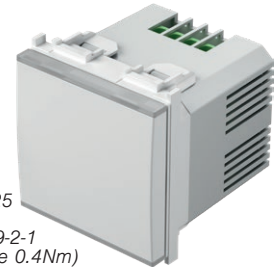

PUSH-BUTTON CONTROL UNIT 2M

- connected to universal dimmer EM25 allows controlling of lamps with same functionality as EM25
- supply voltage 230V ~ 50Hz
- in accordance with EN 60669-1 and EN 60669-2-1
- screw contacts 1.5mm² (max. tightening torque 0.4Nm)

(1) lidhje me dy tela
two-wire connection

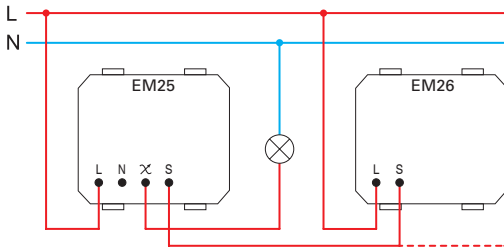

- lidhja me dy tela lejon uljen e ndriçimit të llambave me ulje ndriçimi
- në një lidhje me dy tela secila njësi shtesë kontrolli rrit ngarkesën minimale me 25 W
- two-wire connection allows dimming of dimmable lamps
- in a two-wire connection each additional control unit increases the minimum load by 25W

(2) lidhje me tre tela
three-wire connection

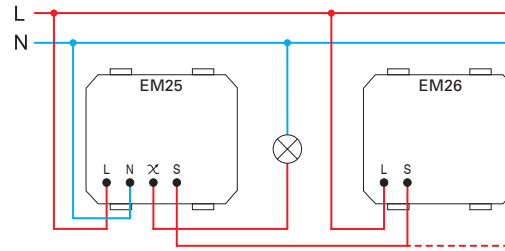

- lidhja me tre tela lejon uljen e ndriçimit të llambave me ulje ndriçimi dhe disa pa ulje ndriçimi dhe llambave CFL
- three-wire connection allows dimming of dimmable lamps and some of non-dimmable LED and CFL lamps



EM27

FILTRI I FREKUENCËS

- filtri i frekuencës për EM25
- imazhi është simbolik
- FREQUENCY FILTER**
- frequency filter for EM25
- image is symbolic

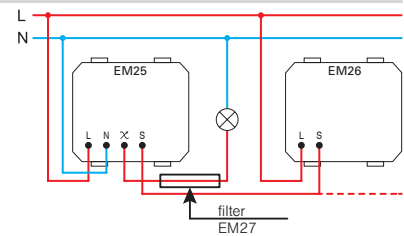

SET ÇELËS / REOSTAT UNIVERSAL RLC 0-300W 2M PP OL20

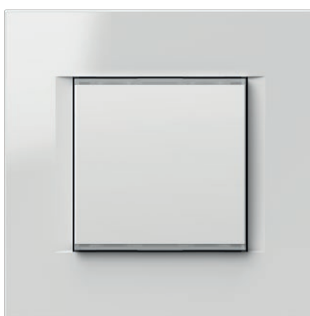

□ EM25PPOL20

- seti përfshin reostatit EM25, kornizën e montimit 2M dhe kapakun mbulues LINE 2M PW
- për detaje teknike shikoni EM25

SET SWITCH / DIMMER UNIVERSAL RLC 0-300W 2M PP OL20

- set includes dimmer EM25, mounting frame 2M and cover plate LINE 2M PW
- for technical details see EM25



2M = 45 x 45

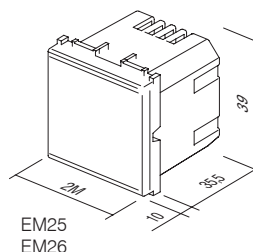

EM25
EM26



- EM31PW
- EM31SB
- EM31AT
- EM31ES
- EM31IW

ÇELËS IR 5A X 230V~ 1M

- çelës IR me infra të kuqe
- tensioni i furnizimit: 230 V~ ±10 % 50 Hz
- rele: 5 A / 250 V~ dalja për rrymën e kufizuar me rezistencë të lartë për kryqëzim zero
- vlerësimi i mbrojtjes: IP40
- prerja e tërthortë e telave në kontakt 0,75 - 2,5 mm²
- zona e zbulimit: deri në 110° në 20°C
- zona e zbulimit: rreth 8 m në 20°C
- rregullimi i kohëzgjatjes: nga rreth 5 sek. në 12 min.
- rregullimi i ndriçimit: nga rreth 5 deri 200 LUX
- temperatura e funksionimit: nga 0°C në +40°C
- i papërshtatshëm për instalim në kuti me thellësi 45 mm dhe kuti montimi në sipërfaqe CUBO IP20
- vetëm për përdorim të brendshëm



IR SWITCH 5A 230V~ 1M

- IR infrared switch
- supply voltage: 230V~ ±10 % 50Hz
- relay: 5A / 250V~ output for limited current with high resistance for zero crossing
- protection rating: IP40
- cross-section of wires at the contact terminal: 0.75 - 2.5 mm²
- detection angle: up to 110° at 20°C
- detection area: approx. 8 m at 20°C
- adjustability of duration: from approx. 5 s to 12 min
- adjustability of brightness: from approx. 5 to 200 LUX
- operating temperature: from 0°C to +40°C
- not suitable for installation in 45 mm deep boxes and surface mount box CUBO IP20
- only for indoor usage



- EM32PW
- EM32SB
- EM32AT
- EM32ES
- EM32IW

IR STIKALO 5 A 230 V~ 2M

- çelës IR me infra të kuqe
- tensioni i furnizimit: 230 V~ ±10 % 50 Hz
- rele: 5 A / 250 V~ dalja për rrymën e kufizuar me rezistencë të lartë për kryqëzim zero
- vlerësimi i mbrojtjes: IP40
- prerja e tërthortë e telave në kontakt 0,75 - 2,5 mm²
- zona e zbulimit: deri në 110° në 20°C
- zona e zbulimit: rreth 8 m në 20°C
- rregullimi i kohëzgjatjes: nga rreth 5 sek. në 12 min
- rregullimi i ndriçimit: nga rreth 5 deri 200 LUX
- temperatura e funksionimit: nga 0°C në +40°C
- i papërshtatshëm për instalim në kuti me thellësi 45 mm dhe kuti montimi në sipërfaqe CUBO IP20
- vetëm për përdorim të brendshëm



IR SWITCH 5A 230V~ 2M

- IR infrared switch
- supply voltage: 230V~ ±10 % 50Hz
- relay: 5A / 250V~ output for limited current with high resistance for zero crossing
- protection rating: IP40
- cross-section of wires at the contact terminal: 0.75 - 2.5 mm²
- detection angle: up to 110° at 20°C
- detection area: approx. 8 m at 20°C
- adjustability of duration: from approx. 5 s to 12 min
- adjustability of brightness: from approx. 5 to 200 LUX
- operating temperature: from 0°C to +40°C
- not suitable for installation in 45 mm deep boxes and surface mount box CUBO IP20
- only for indoor usage

gama e zbulimit /
detection range

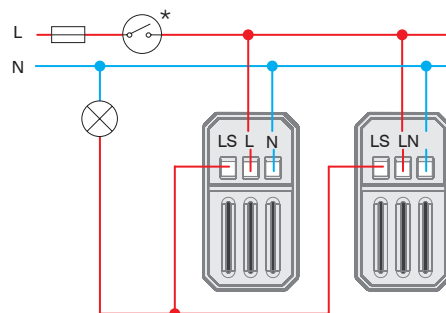
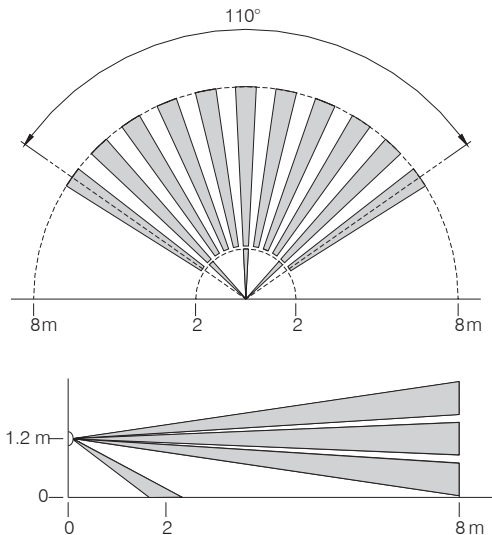

koha dhe rregullimi për muzgun /
time and twilight adjustment

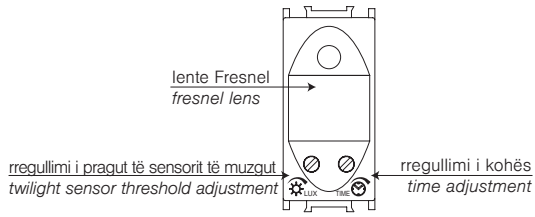

5 LUX	~5 s	200 LUX
		~12 min

	1	2	3	4	5	6	7	8
Min.	1 W	1 W		1 VA	1 W	1 W	1 VA	1 VA
Max.	800 W	800 W	5A	6x20 VA	6x36 W	4x36 W (20µF)	6x23 VA	6x20 VA

1 - llambë inkandeshente /
incandescent lamp

2 - llambë halogjene /
halogen lamp

3 - element ngrohjeje me rezistencë /
resistive heating element

4 - transformator elektrik /
electronic transformer

5 - llambë neoni fluoreshente (versioni 1) /
fluorescent tube (version 1)

6 - llambë neoni fluoreshente (versioni 2) /
fluorescent tube (version 2)

7 - llambë CLF me kursim energjie /
energy saving CFL lamp

8 - llambë LED /
LED lamp

kujdes /
attention

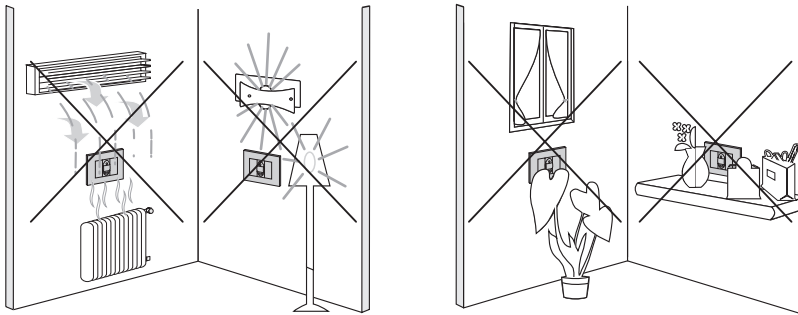

1M = 22,5 x 45

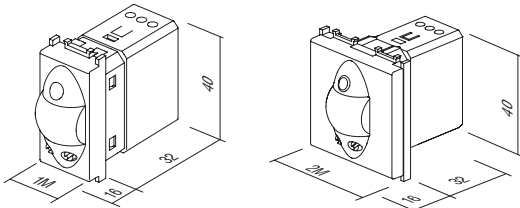

TERMOSTAT BAZË 6 A 230 V ~ 2M



- EM37PW
- EM37SB
- EM37AT
- EM37ES
- EM37IW



Termostatit është i destinuar për rregullimin e temperaturës në dhomë. Termostatit mundëson dy regjime funksionimi - ngrohje ose ftohje. Ai ka funksione sigurie të instaluar për mbrojtje kundër ngrirjes (regjimi i ngrohjes) dhe mbrojtje kundër mbinxehjes (regjimi i ftohjes). Funksionimi tregohet përmes dritave LED. Konfigurimi i termostatit kryhet me ndihmën e një butoni rrotullues për caktimin e temperaturës dhe me butona të tjerë me prekje kapacitive.

The thermostat is intended for regulating temperature in a room. A thermostat enables two modes of operation – heating or cooling. It has safety functions installed for protection against freezing (heating mode) and protection against overheating (cooling mode). The operation is indicated via LED lights. Thermostat setup is performed with the help of a rotary button for setting the temperature and with other capacitive touch buttons.

- termostat elektronik, bazë
- regjimi i funksionimit: ngrohje/ftohje/fikje
- tensioni i furnizimit: 230 V AC, 50 Hz
- dalja: 6(2) A, 230 V AC, çelësi i relesë
- gama e rregullimit: +10 °C deri +30 °C
- histereza: ±0,5 °C, ED = 20 min
- mbrojtja kundër ngrirjes (regjimi i ngrohjes): +6 °C
- mbrojtja nga mbinxehja (regjimi i ftohjes): +32 °C
- funksioni ECO për uljen e temperaturës me 3 °C për 6 orë në regjimin e ngrohjes dhe rritjen e temperaturës me 3 °C për 6 orë në regjimin e ftohjes
- funksioni përshtatës ECO, automatikisht çdo ditë në të njëjtën orë ul temperaturën me 3 °C për 6 orë në regjimin e ngrohjes dhe e rrit temperaturën me 3 °C për 6 orë në regjimin e ftohjes
- opsioni për të aktivizuar regjimin e funksionimit ECO me aktivizim të jashtëm përmes një hyrjeje të veçantë
- treguesi LED i funksionimit
- i papërshtatshëm për ngrohje elektrike nga dyshemeja
- kontaktet e vidave maks. 2,5 mm²
- në përputhje me Direktivën LV, Direktivën EMC, standardet EN60730-1 dhe EN60730-2-9
- për funksionim të saktë, rekomandojmë instalimin e një kutie të pavarur, të ndarë nga pajisjet që gjenerojnë nxehtësi
- temperatura e funksionimit: 5 ÷ 35 °C
- temperatura e magazinimit: -20 ÷ 50 °C

THERMOSTAT BASIC 6A 230 V ~ 2M

- electronic thermostat, basic
- operation mode: heating/cooling/turn off
- power supply: 230 VAC, 50 Hz
- output: 6(2) A, 230 VAC, relay switch
- regulation range: +10 °C to +30 °C
- hysteresis: ±0.5 °C, ED = 20min
- anti-freeze protection (heating mode): +6 °C
- overheating protection (cooling mode): +32 °C
- ECO function for lowering the temperature by 3 °C for 6 hours in the heating mode and raising temperature by 3 °C for 6 hours in the cooling mode
- adaptive ECO function, automatically every day at the same time lowers the temperature by 3 °C for 6 hours in the heating mode and raises temperature by 3 °C for 6 hours in the cooling mode
- option to turn on the ECO operating mode by external trigger via a separate input
- LED indication of operation
- not suitable for electrical floor heating
- screw contacts max. 2.5 mm²
- in accordance with the LV Directive, the EMC Directive, standards EN60730-1 and EN60730-2-9
- for correct operation, we recommend installing in an independent single box, separate from devices that generate heat
- operating temperature: 5 ÷ 35 °C
- storage temperature: -20 ÷ 50 °C

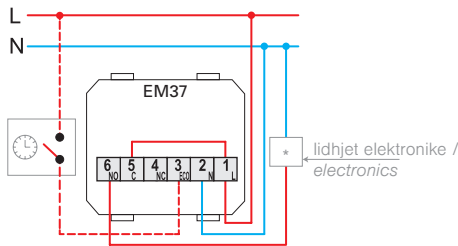

pompa e qarkullimit, vatra (lidhja direkte),
transmission termoelektrik /
circulation pump, burner (direct connection)
thermoelectric drive

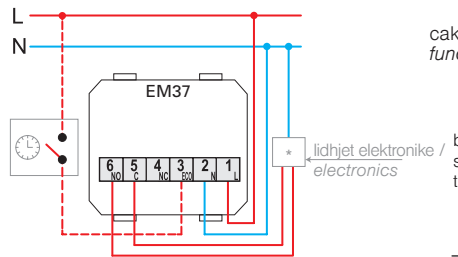

bojleri, pompa e nxehtësisë, vatra (hyrja e kontrollit T1/T2) /
boiler, heat pump, burner (control input T1/T2)

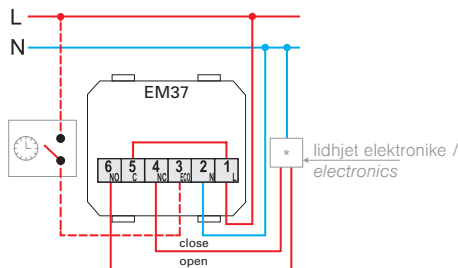

transmissioni me motor (përdorim i kufizuar me ngrohje nën dysheme) /
motor drive (limited use with underfloor heating)

caktimi i funksionit në temperaturë /
function and temperature adjustment

butoni i përzgjedhjes së funksioneve dhe treguesit i statusit të LED-it:
e kuqe: ngrohje
blu: kondicioner pa ndriçim: e fikur

function selection button and LED status indicator:
red: heating
blue: air conditioning
no light: switched off

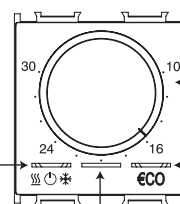

caktimi i funksionit të temperaturës
temperature setting

butoni i përzgjedhjes së funksioneve "ECO" dhe treguesit të statusit "ECO" të LED-it e gjelbër: kursimi i energjisë ECO aktiv portokalli: regjimi ECO adaptiv i aktivizuar pa ndriçim: regjimi i ditës

"ECO" function selection button and LED "ECO" status indicator
green: ECO energy saving ON
orange: adaptive ECO mode activated
no light: day mode

treguesi LED i gjendjes së relesë së daljes e bardhë: releja e ndezur pa ndriçim: releja e fikur

LED output relay state indicator
white: relay ON
no light: relay OFF

kujdes /
attention

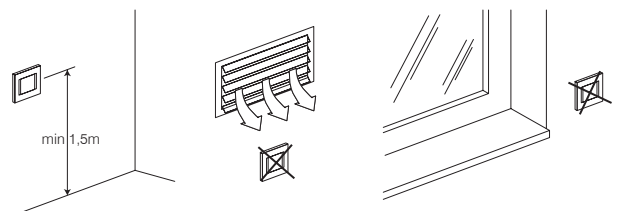

2M = 45 x 45

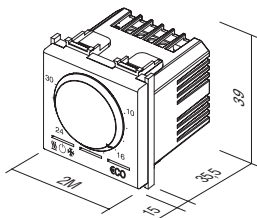

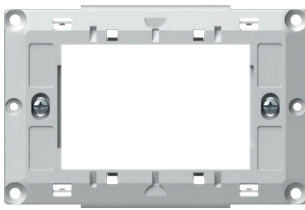

NM39

KORNIZË MONTIMI ME VIDA PËR TERMOSTATE FANTINI COSMI 3M

- kornizë montimi me vida për termostate Fantini Cosmi 3M
- i përshtatshëm për përdorim me modelet e përditshme të termostateve Fantini Cosmi CH121 dhe CH123
- i përshtatshëm për përdorim me modelet javore të termostateve Fantini Cosmi CH141A dhe CH143A
- për montim në kutitë drejtkëndore 3M
- i përshtatshëm për montimin me kapakët mbulues PURE, Line, Soft



MOUNTING FRAME WITH SCREWS FOR FANTINI COSMI THERMOSTATS 3M

- mounting frame with screws for Fantini Cosmi thermostats 3M
- suitable for use with Fantini Cosmi daily thermostats models CH121 and CH123
- suitable for use with Fantini Cosmi weekly thermostats models CH141A and CH143A
- for mounting in rectangular boxes 3M
- suitable for assembling with cover plates PURE, Line, Soft



- EM40PW
- EM40SB
- EM40AT
- EM40ES
- EM40IW

ÇELËSI I KARTËS SË KURSIMIT TË ENERGJISË 3 A 250 V~ 3M

- çelës karte bazë, çdo kartë ISO
- tensioni i furnizimit, 230 V ~ 50 Hz
- dalja 3 A 250 V~ për kontaktorin e çelësit *
- vonesa e fikjes 15-20 sek.
- në përputhje me EN 61000-6-1
- karta nuk është e përfshirë
- jo për kontrollin e aksesit



ENERGY SAVER CARD SWITCH 3A 250V~ 3M

- card switch basic, any ISO card
- supply voltage 230V ~ 50Hz
- output 3A 250V~ for switching contactor *
- switch off delay 15-20s
- in accordance with EN 61000-6-1
- card is not included
- not for access control

3M = 67,5 x 45

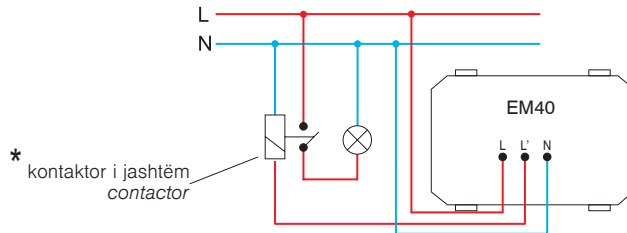
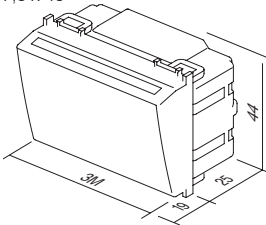

* kontaktor i jashtëm
contactor

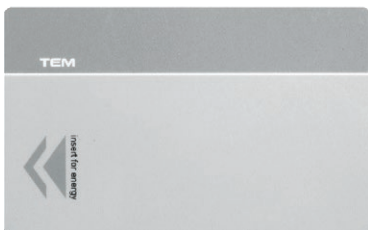

EM47

KARTË ISO

- kartë ISO
- për kombinim me çelës karte EM40
- madhësia: 85x54 mm

CARD ISO

- ISO card
- for combination with card switch EM40
- size: 85x54 mm

ÇELËS KARTË PËR KURSIM TË ENERGJISË RF HF 13,56 MHz 3M



EM44BK

- çelës kartë elektronike për kartë RFID ISO
- furnizimi nga njësia e relesë EM49 përmes konektorëve të kabllave RJ12
- dalja të lidhet me njësinë e daljes së relesë EM49
- vonesë 15-20 sek. e çelësit "kryesor të energjisë" me heqjen e kartës
- vonesë 1 min. e çelësit "HVAC" me heqjen e kartës kur hapen dyert ose dritaret e ballkonit
- në përputhje me EN 61000-6-1
- karta nuk është e përfshirë
- jo për kontrollin e aksesit

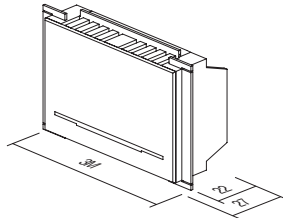

ENERGY SAVER CARD SWITCH RF HF 13,56MHz 3M

- electronic card switch for RFID ISO card
- supply from relay unit EM49 through cable connectors RJ12
- output to be connected to relay output unit EM49
- 15-20s "main power" switch off delay with card withdrawal
- 1 min "HVAC" switch off delay with card withdrawal when balcony doors or windows opened
- in accordance with EN 61000-6-1
- card is not included
- not for access control

NJËSIA E KONTROLLIT TË KURSIMIT TË ENERGJISË 2x16 A 250 V~

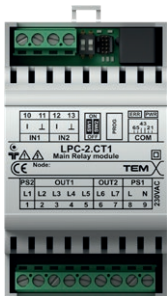

EM49

- njësi releje për çelësat e kartës EM44
- tensioni i furnizimit, 230 V ~ 50 Hz
- në përputhje me EN 61000-6-1
- montim në shinë DIN 35 mm, 3MU
- hyrje dhe dalje në varësi të implementimit: dhomë njëshe ose dyshe

ENERGY SAVER CONTROL UNIT 2x16A 250V~

- relay unit for card switches EM44
- supply voltage 230V~ 50Hz
- in accordance with EN 61000-6-1
- mounting on DIN rail 35mm, 3MU
- input and output depending on implementation: single or double room

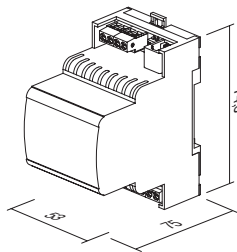

SHPËRNDARËS SPL-1



EM45

- përdoret për të lidhur dy module periferike EM44 me njësinë e relesë EM49
- konektori i komunikimit RJ12
- madhësia: 37 x 30 x 27 mm

SPLITTER SPL-1

- used to connect two peripheral modules EM44 to relay unit EM49
- communication connector RJ12
- size: 37 x 30 x 27 mm

skema e instalimeve elektrike për implementim në dhomë njëshe / wiring diagram for single room implementation

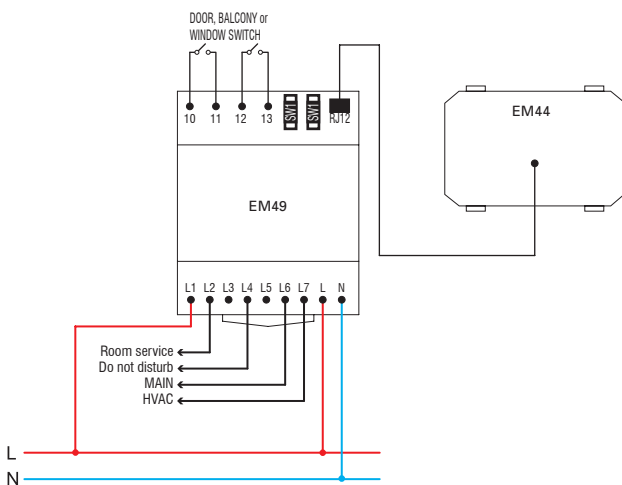

skema e instalimeve elektrike për implementim në dhomë dyshe / wiring diagram for double room implementation

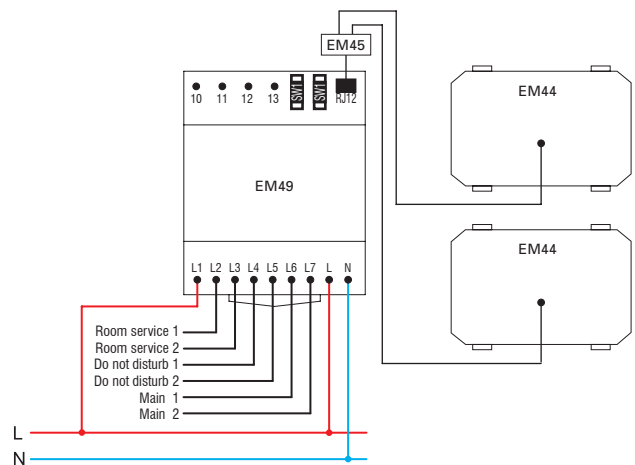

kabllloja e lidhjes RJ12 mes EM44 dhe EM49 / connection cable RJ12 between EM44 and EM49

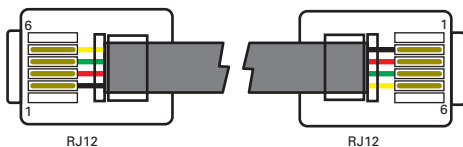



- EM60PW
- EM60SB
- EM60AT
- EM60ES
- EM60IW

PRIZË PËR RROJË 230 V~/120 V~ 3M

- njësi furnizimi për rrojë me transformator izolues 20 VA
- furnizimi: 230 V~ 50-60 Hz
- dalja: 230 V~ për 2P 2,5 A spinë Euro ose 120V~ për 2P 15 A spinë amerikane
- Klasi II
- në përputhje me EN 61558-2-5



SOCKET SHAVER 230V~/120V~ 3M

- shaver supply unit with isolating transformer 20VA
- supply: 230V~ 50-60Hz
- output: 230V~ for 2P 2.5A Europlug or 120V~ for 2P 15A American plug
- Class II
- in accordance with EN 61558-2-5

3M = 67,5 x 45

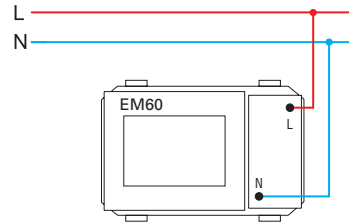
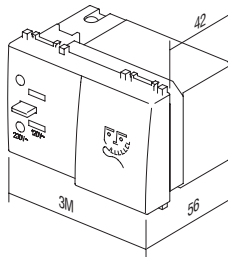

- EM66PW
- EM66SB
- EM66AT
- EM66ES
- EM66IW

NJËSIA E FURNIZIMIT ME ENERGJI USB 5 V 2,1 A 1M

- për karikimin e pajisjeve elektronike përmes një porte standarde USB (e përputhshme gjithashtu edhe me pajisjet Apple)
- furnizimi me energji: 100-230 V~ 50/60 Hz
- konsumi i energjisë: 300 mA në 100 V~/150 mA në 230 V~
- konsumi i energjisë në gatishmëri: 30mW në 230 V~
- tensioni nominal në dalje: 5 VDC (±5 %) SELV
- tensioni i ondulacionit në dalje: 150 mV
- rryma nominale në dalje: 2,1 A (1 x 2100 mA) (±10 %)
- efikasiteti: maksimumi 77%
- temperatura e funksionimit: 0°C/+45°C (përdorimi i brendshëm)
- Klasi i mbrojtjes IP: IP20, vetëm për përdorim në ambiente të brendshme
- klasi i pajisjes II
- kategoria e mbitensionit (EN 62109): klasi III
- kontaktet e vidave: maks. 2,5 mm²
- pajisje me hapësirë kontakti prej të paktën 3 mm
- në përputhje me standardet EN 60950-1 dhe Direktivës LVC dhe EMC

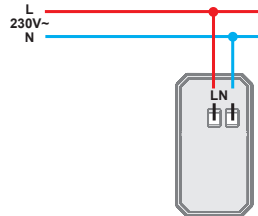
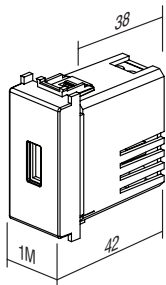

USB POWER SUPPLY UNIT 5V 2,1A 1M

- for charging of electronic devices via a standard USB port (also compatible with Apple devices)
- power supply: 100-230V~ 50/60Hz
- power consumption: 300mA at 100V~/150mA at 230V~
- standby power consumption: 30mW at 230V~
- nominal output voltage: 5 VCD (± 5%) SELV
- output ripple voltage: 150mV
- nominal output current: 2,1A (1 x 2.100mA) (±10%)
- efficiency: maximum of 77%
- operating temperature: 0°C/+45°C (indoor use)
- IP protection class: IP20, indoor use only
- class device II
- overvoltage category (EN 62109): Class III
- screw contacts: max. 2.5 mm²
- device with a contact gap of at least 3mm
- in accordance with EN 60950-1 and LVD & EMC directives

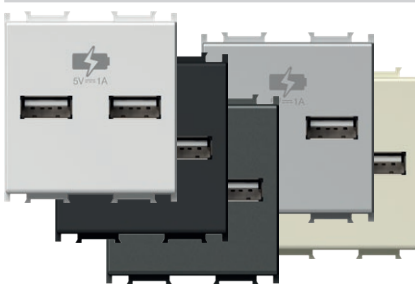

- EM65PW
- EM65SB
- EM65AT
- EM65ES
- EM65IW

NJËSI FURNIZIMI ME ENERGJI USB 5 V 1 A 2M

- për karikimin e pajisjeve elektronike përmes një porte standarde USB (e përputhshme gjithashtu edhe me pajisjet Apple)
- mundëson karikimin e dy pajisjeve njëkohësisht
- tensioni i furnizimit: 230 V~ 50 Hz
- konsumi i energjisë në gatishmëri: 50 mW në 230 V~
- tensioni nominal në dalje: 5 VDC (±5%) SELV
- tensioni i ondulacionit në dalje: 150 mV
- rryma nominale në dalje: 1 A (1 x 1000 mA ose 2 x 500 mA) (±10%)
- efikasiteti: më i madh se 67%
- klasi i mbrojtjes IP: IP20, vetëm për përdorim në ambiente të brendshme
- kontaktet e vidave 2,5 mm²
- në përputhje me standardet EN 60950-1 dhe Direktivës EMC
- duhet të konsiderohet si pjesë e instalimit një pajisje shkëputëse e jashtme

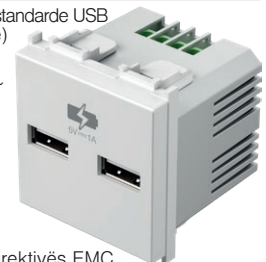

2M = 45 x 45

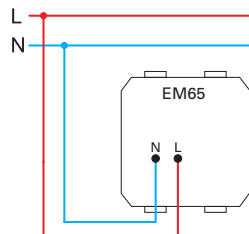
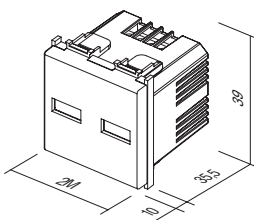

POWER SUPPLY UNIT USB 5V 1A 2M

- for charging of electronic devices via a standard USB port (also compatible with Apple devices)
- enables charging of two devices simultaneously
- power supply: 230V~ 50Hz
- stand-by power consumption: 50 mW at 230V~
- nominal output voltage: 5 VDC (±5%) SELV
- output ripple voltage: 150 mV
- nominal output current: 1 A (1 x 1.000 mA or 2 x 500 mA) (±10%)
- efficiency: greater than 67%
- IP protection class: IP20, indoor use only
- screw contacts: max. 2.5 mm²
- in accordance with EN 60950-1 and EMC directive
- an appropriate external disconnect device needs to be considered as part of installation



- EM67PW
- EM67SB
- EM67AT
- EM67ES
- EM67IW

NJËSIA E FURNIZIMIT ME ENERGJI USB 5 V 2,4 A 1M

- për karikimin e pajisjeve elektronike përmes një porte standarde USB (e përputhshme gjithashtu edhe me pajisjet Apple)
- furnizimi me energji: 100-230 V~ 50/60 Hz
- konsumi i energjisë: 300 mA në 100 V~/150 mA në 230 V~
- konsumi i energjisë në gatishmëri: 30mW në 230 V~
- tensioni nominal në dalje: 5 VDC (±5 %) SELV
- tensioni i ondulacionit në dalje: 150 mV
- rryma nominale në dalje: 2,4 A (±10 %)
- efikasiteti: maksimumi 77%
- temperatura e funksionimit: 0°C/+45°C (përdorimi i brendshëm)
- Klasi i mbrojtjes IP: IP20, vetëm për përdorim në ambiente të brendshme
- klasi i pajisjes II
- kategoria e mbtensionit (EN 62109): klasi III
- kontaktet e vidave: maks. 2,5 mm²
- pajisje me hapësirë kontakti prej të paktën 3 mm
- në përputhje me standardet EN 60950-1 dhe Direktivës LVC dhe EMC

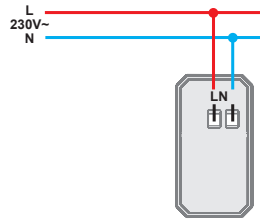
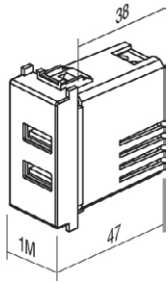

USB POWER SUPPLY UNIT 5V 2,4A 1M

- for charging of electronic devices via a standard USB port (also compatible with Apple devices)
- power supply: 100-230V~ 50/60Hz
- power consumption: 300mA at 100V~/150mA at 230V~
- standby power consumption: 30mW at 230V~
- nominal output voltage: 5 VDC (± 5%) SELV
- output ripple voltage: 150mV
- nominal output current: 2,4A (±10%)
- efficiency: maximum of 77%
- operating temperature: 0°C/+45°C (indoor use)
- IP protection class: IP20, indoor use only
- class device II
- overvoltage category (EN 62109): Class III
- screw contacts: max. 2.5 mm²
- device with a contact gap of at least 3mm
- in accordance with EN 60950-1 and LVD & EMC directives

DRITË EMERGJENCE LED 250 V~ 0,90 W, NiCd 3h 7M



- EM55

- dritë emergjence LED
- tensioni i furnizimit 250 V~ 50 Hz 3x LED 0,3 W, 10000 mcd, 6500K
- akumulator NiCd 400 mAh, i ndërrueshëm
- autonomia 3 orë, karikimi 24h
- Klasi II
- në përputhje me standardet EN 60598-1, EN 60598-2-2, EN 60598-2-22



LED EMERGENCY LIGHT 250V~ 0.90W, NiCd 3h 7M

- emergency LED lamp
- supply voltage 250V~ 50Hz 3x LED 0,3W, 10000mcd, 6500K
- NiCd accumulator 400 mAh, replaceable
- autonomy 3h, charging 24h
- Class II
- in accordance with EN 60598-1, EN 60598-2-2, EN 60598-2-22

7M = 151,5 x 45

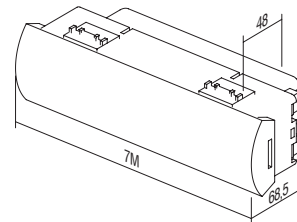
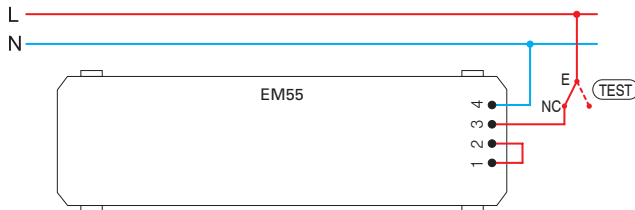

DRITË EMERGJENCE LED 230 V~50 Hz, 0,5 W, NiMH 2 ORË 2M



- EM57

- llambë emergjence LED
- opsjon për ta përdorur si llambë koke (mekanizmi me tërheqje)
- tensioni i furnizimit 230 V~50 Hz, 1xLED 0,5 W
- Akumulator NiMH 140 mAh, i zëvendësueshëm
- autonomia 2 orë, karikimi 36 orë
- klasi i pajisjes II
- në përputhje me standardet EN60598-1, EN60598-2-2, EN62471, EN55015:2006, EN61547

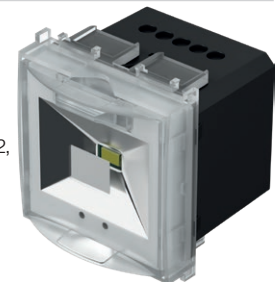

LED EMERGENCY LIGHT 230V~50Hz, 0.5W, NiMH 2h 2M

- emergency LED lamp
- option to use it as a hand lamp (pull-out mechanism)
- supply voltage 230V~50Hz, 1xLED 0.5W
- NiMH accumulator 140mAh, replaceable
- autonomy 2h, charging 36h
- class device II
- in accordance EN60598-1, EN60598-2-2, EN62471, EN55015:2006, EN61547

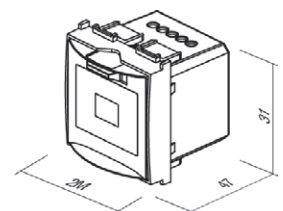
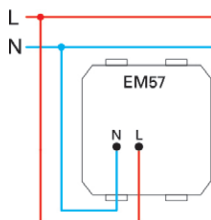

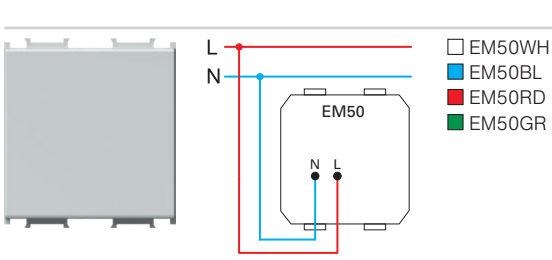

LLAMBË LED NJËNGJYRËSHE 250 V~ 0,8 W 2M

- llambë LED shënuese
- tensioni i furnizimit, 230 V ~ 50 Hz, 0,8 W, 6500K
- Klasi II
- në përputhje me EN 60598-1
- përdorim opsional për ndriçimin e drejtit ose sinjalit me printim të personalizuar me lazer në difuzor

LED LAMP MONOCOLOR 250V~ 0,8W 2M

- step marker LED lamp
- supply voltage 230V~ 50Hz 0,8W, 6500K
- Class II
- in accordance with EN 60598-1
- optional usage for directional or signal illumination with customized laser printing on diffuser

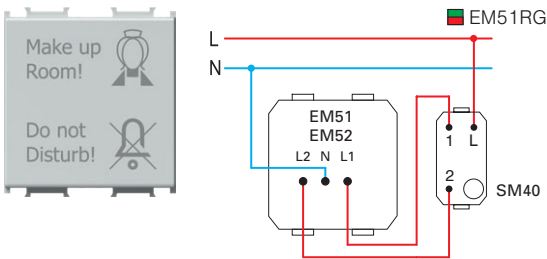

LLAMBË LED ME DY NGJYRA 250 V~ 2 x 0,4 W 2M

- llambë LED sinjalizuese me dy ngjyra (e kuqe/e gjelbër)
- tensioni i furnizimit, 230 V ~ 50 Hz, 0,8 W, 6500K
- Klasi II
- në përputhje me EN 60598-1
- difuzori përfshin grafikët siç tregohet
- mundësi për printim të personalizuar me lazer në difuzor

LED LAMP DUAL COLOR 250V~ 2x0,4W 2M

- signaling dual color (red/green) LED lamp
- supply voltage 230V~ 50Hz 2x0,4W, 6500K
- Class II
- in accordance with EN 60598-1
- diffuser includes graphics as shown
- possible customized laser printing on diffuser

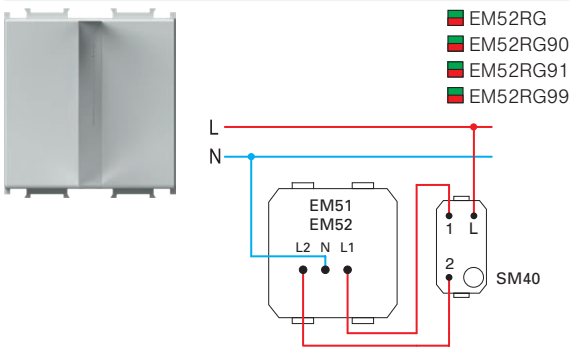
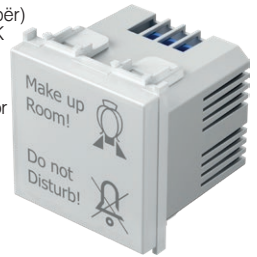

LLAMBË LED 3D ME DY NGJYRA 250 V~ 2 x 0,4 W 2M

- llambë LED sinjalizuese me dy ngjyra (e kuqe/e gjelbër) me simbol 3D
- tensioni i furnizimit, 230 V ~ 50 Hz, 0,8 W, 6500K
- Klasi II
- në përputhje me EN 60598-1
- mundësi për grafikë të personalizuar sipas kërkesës
- 90 simbol mashkull, 91 simbol femër, 99 simbol sipas kërkesës

LED LAMP 3D DUAL COLOR 250V~ 2x0,4W 2M

- signalling LED lamp, dual color (red/green) with 3D symbol
- supply voltage 230V~ 50Hz 2x0,4W, 6500K
- class II
- in accordance with EN 60598-1
- possible customized graphics on request
- 90 male symbol, 91 female symbol, 99 symbol on request

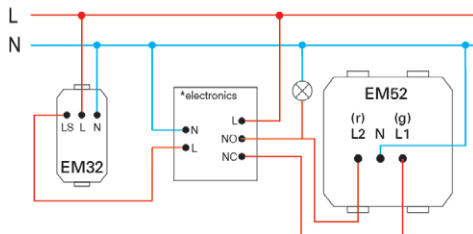
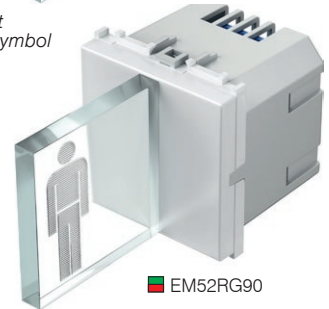
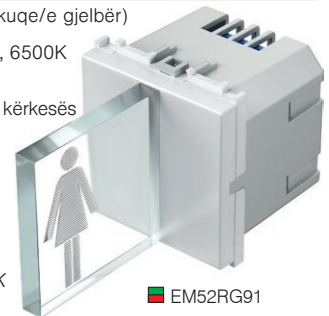

2M = 45 x 45

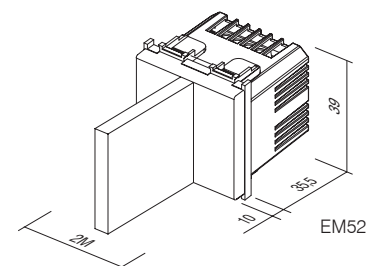
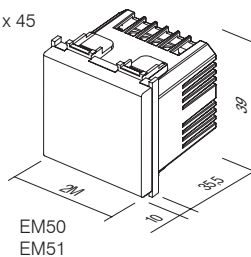



- EM71PW
- EM71SB
- EM71AT
- EM71ES
- EM71IW

ÇELËS ME GJURMË GISHTI BIOPASS 2M

- çelës me gjurmë gishti me njësi releje të brendshme dhe furnizim me energji
- Kapaciteti: 500 gjurmë gishtash
- Menaxhim i lehtë përmes aplikacionit për celular X-Manager
- Tensioni i furnizimit me energji: 8-30 V – DC ose AC (përfshihet furnizimi me energji)
- Sensor me prekje kapacitative
- Rele me 2 dalje
- Tensioni/rryma maksimale në rele: 40 V/3 A
- Koha e aktivizimit të relesë: 1-10 sek.
- Fuqia maksimale: 3,6 W
- lidhje e enkriptuar 256-bit mes çelësit dhe njësisë së relesë së brendshme
- Seti përfshin gjithashtu kornizën e montimit NM24 dhe pllakën e kapakut dekorativ OS20.

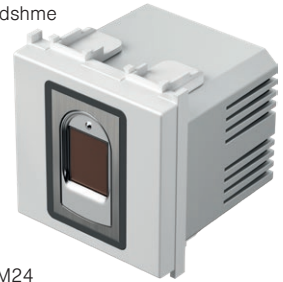

FINGERPRINT SWITCH BIOPASS 2M

- fingerprint switch with included internal relay unit and power supply
- capacity: 500 fingerprints
- easy management via X-Manager mobile app
- power supply voltage: 8-30V – DC or AC (power supply included)
- capacitive sensor
- 2 output relays
- maximum voltage/current on relay: 40V/3A
- relay triggering time: 1-10 sec
- maximum power: 3.6W
- 256-bit encrypted link between switch and internal relay unit
- Set also includes NM24 mounting frame and OS20 decorative cover plate.

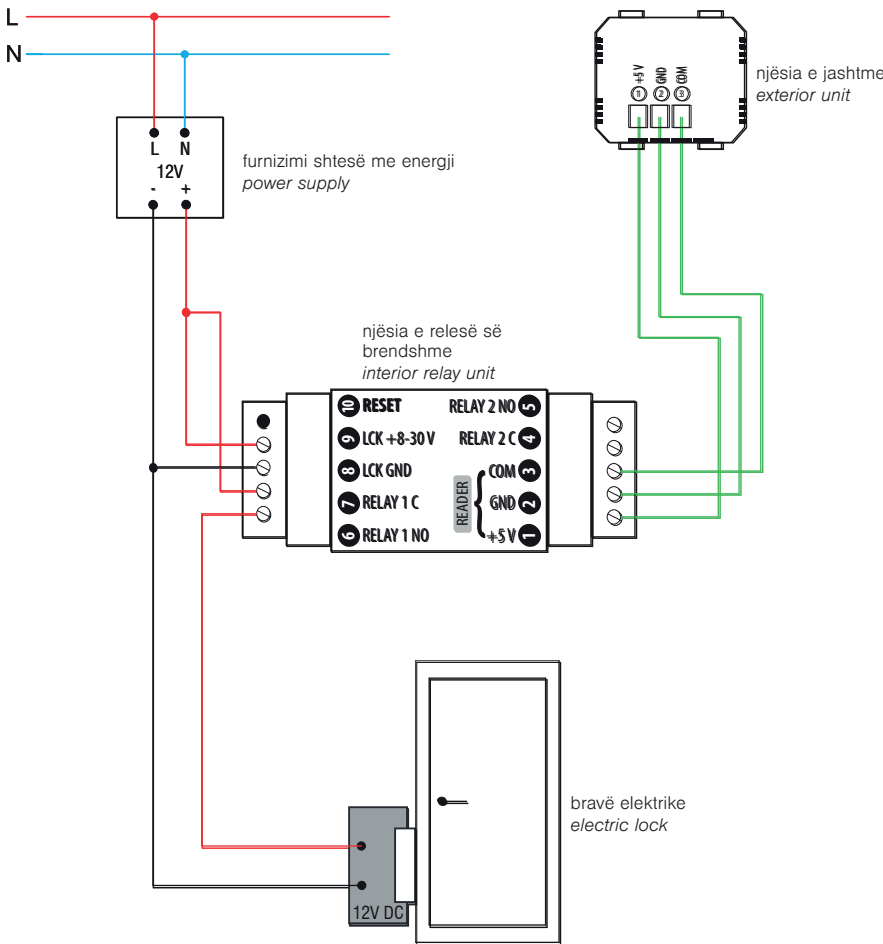

X-Manager app



support.tem.si



njësia e jashtme exterior unit

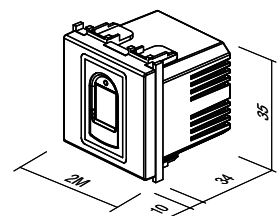

ÇELËS, PA PREKJE 10 A 240 V~



■ EM80GW

- çelës pa prekje për ndezje/fikje ("master")
- furnizimi me energji: 240 V~ 50 Hz
- releja e daljes 10 A / 250 V~ (2400 W në 240 V~)
- gama e rregullueshme nga 2 deri 10 cm
- për instalimin në kuti të rrumbullakët standarde Ø60 mm
- për lidhjen kërkohet një tel nul (N)
- nuk është e mundur lidhja me çelës me 2 drejtime
- është e mundur lidhja me deri në 5 çelësa kontrolli EM81
- instalim i lehtë i kapakëve dekorativë me ndihmën e magnetëve
- shtrëngimi i vidave të telave deri në 2,5 mm² (maks. forca e shtrëngimit të vidës është 0,4 Nm)
- në përputhje me standardet EN 60669-1 dhe EN 60669-2-1
- vetëm për përdorim të brendshëm



SWITCH, TOUCHLESS 10A 240V~

- touchless switch for turning on/off ("master")
- power supply: 240 V~ 50 Hz
- output relay 10A / 250V~ (2400W at 240V~)
- adjustable range from 2 to 10 cm
- intended for installation into a standard round Ø60 mm box
- a neutral lead (N) is required for connection
- connection with toggle switches is not possible
- connection with up to 5 EM81 control switches is possible
- simple installation of decorative covers with the help of magnets
- screw fastening of leads up to 2.5 mm² (max. screw tightening torque is 0.4 Nm)
- in accordance with EN 60669-1 and EN 60669-2-1
- only for indoor use

ÇELËS, PA PREKJE, NJËSI KONTROLLI



■ EM81GW

- çelësi i kontrollit ("slave")
- funksionon vetëm kur lidhet me çelësin EM80 ("master")
- gama e rregullueshme nga 2 deri 10 cm
- instalim i lehtë i kapakëve dekorativë me ndihmën e magnetëve
- shtrëngimi i vidave të telave deri në 2,5 mm² (forca maks. e shtrëngimit të vidës është 0,4 Nm)
- në përputhje me standardet EN 60669-1 dhe EN 60669-2-1
- vetëm për përdorim të brendshëm

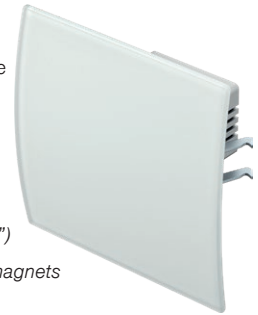

SWITCH, TOUCHLESS, CONTROL UNIT

- control switch ("slave")
- works only when connected with the EM80 switch ("master")
- adjustable range from 2 to 10 cm
- simple installation of decorative covers with the help of magnets
- screw fastening of leads up to 2.5 mm² (max. screw tightening torque is 0.4 Nm)
- in accordance with EN 60669-1 and EN 60669-2-1
- only for indoor use

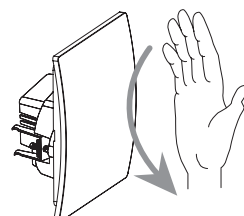
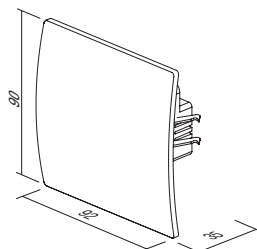
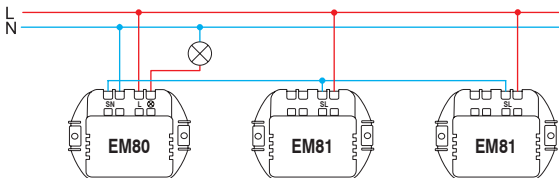
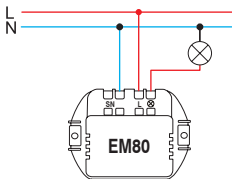

SINJALIZUES 8 VA 230 V~1M

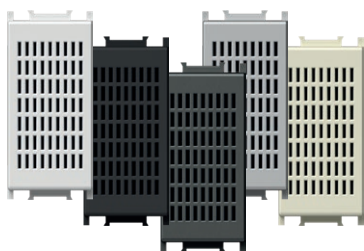

- EM90PW
- EM90SB
- EM90AT
- EM90ES
- EM90IW

- sinjalizues
- dalja e tingullit ka të njëjtën kohëzgjatje si funksionimi i kontrollit
- tensioni i furnizimit, 230V ~ 50 Hz 8 VA

BUZZER 8VA 230V~1M

- signal buzzer
- the sound emission has the same lasting time as the control operation
- supply voltage 230V~ 50Hz 8VA



SINJALIZUES 8 VA 12 V~1M

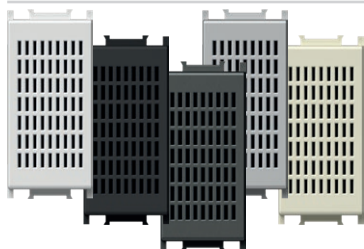

- EM91PW
- EM91SB
- EM91AT
- EM91ES
- EM91IW

- sinjalizues
- dalja e tingullit ka të njëjtën kohëzgjatje si funksionimi i kontrollit
- tensioni i furnizimit, 12V ~ 50 Hz 8 VA

BUZZER 8VA 12V~1M

- signal buzzer
- the sound emission has the same lasting time as the control operation
- supply voltage 12V~ 50Hz 8VA



ZILE 8 VA 230 V~1M

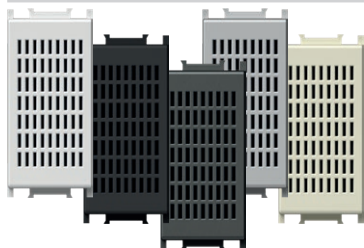

- EM92PW
- EM92SB
- EM92AT
- EM92ES
- EM92IW

- zile sinjalizuese
- dalja e tingullit ka të njëjtën kohëzgjatje si funksionimi i kontrollit
- tensioni i furnizimit, 230V ~ 50 Hz 8 VA

BELL 8VA 230V~1M

- signal bell
- the sound emission has the same lasting time as the control operation
- supply voltage 230V~ 50Hz 8VA



ZILE 8 VA 12V~1M

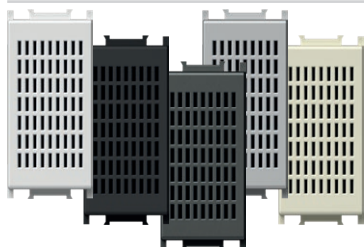

- EM93PW
- EM93SB
- EM93AT
- EM93ES
- EM93IW

- zile sinjalizuese
- dalja e tingullit ka të njëjtën kohëzgjatje si funksionimi i kontrollit
- tensioni i furnizimit, 12V ~ 50 Hz 8 VA

BELL 8VA 12V~1M

- signal bell
- the sound emission has the same lasting time as the control operation
- supply voltage 12V~ 50Hz 8VA

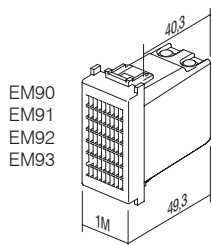

EM90
EM91
EM92
EM93

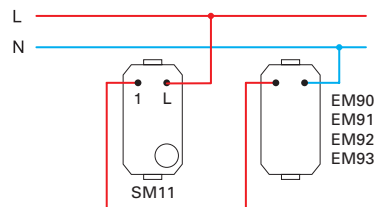

EM90
EM91
EM92
EM93

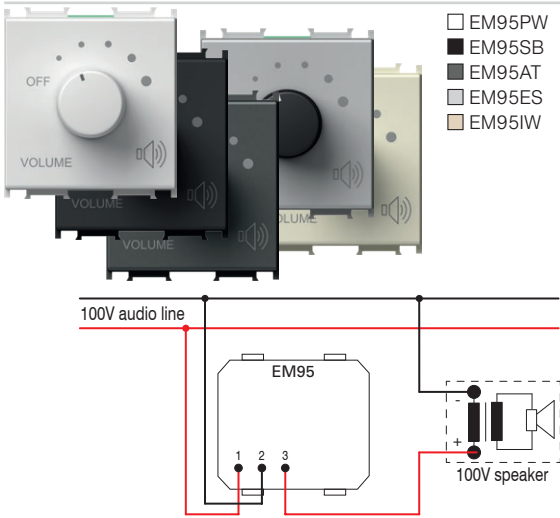

KONTROLL VOLUMI 100 V LINJË AUDIO 35 W 2M

- kontroll volumi (atenuator) për sisteme audio 100 V
- vlerësimi i fuqisë 35 W (maks. 45 W), 6 hapa kontrolli volumi
- i përshtatshëm për kuti (min. 60 mm thellësi)
- i papërshtatshëm për instalim në kuti me thellësi 45 mm dhe kuti montimi në sipërfaqe CUBO IP20
- vetëm për përdorim të brendshëm

VOLUME CONTROL 100V AUDIO LINE 35W 2M

- volume control (attenuator) for 100V audio systems
- power rating 35W (max.45W), 6 steps volume control
- suitable for boxes min. 60 mm deep
- not suitable for installation in 45 mm deep boxes and surface mount boxes CUBO IP20
- for indoor use only

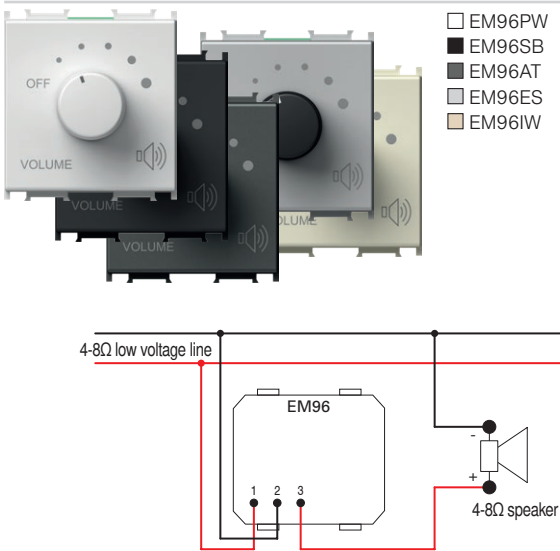
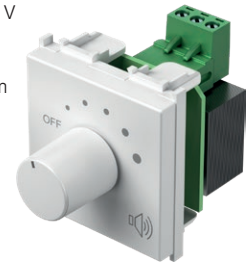

KONTROLL VOLUMI 4-8 Ω 35 W 2M

- kontroll volumi (atenuator) për dalje të tensionit të ulët 4-8 Ω, 35 W
- mundësi lidhjeje me pajisjet HI-FI
- fuqi nominale 35 W, kontroll i volumit me 6 hapa
- i përshtatshëm për kuti (min. 60 mm thellësi)
- i papërshtatshëm për instalim në kuti me thellësi 45 mm dhe kuti montimi në sipërfaqe CUBO IP20
- vetëm për përdorim të brendshëm

VOLUME CONTROL 4-8 Ω 35W 2M

- volume control (attenuator) for low voltage outputs 4-8 Ω, 35W
- power rating 35W, 6 steps volume control
- suitable for boxes min. 60 mm deep
- not suitable for installation in 45 mm deep boxes and surface mount boxes CUBO IP20
- for indoor use only

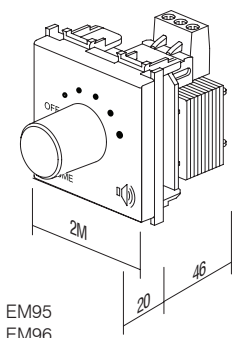
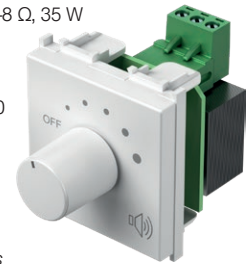

EM95
EM96



CM25

PW

OS

Iloji type	përshkrimi description	të dhënat teknike technical data	madhësia size	ngjyra colour	të dhënat opsionale 1 optional data 1
CM10	SET PRIZE 2x SCHUKO SOCKET SET 2x SCHUKO	2P+E 16A 250V~	4M	<input type="checkbox"/> PW e bardhë polare polar white	<input type="checkbox"/> OL kapak mbulues LINE cover plate LINE
CM11	SET PRIZE 3x SCHUKO SOCKET SET 3x SCHUKO	2P+E 16A 250V~	7M	<input checked="" type="checkbox"/> SB e zezë soft touch soft touch black	<input type="checkbox"/> OS kapak mbulues SOFT cover plate SOFT
CM15	SET LIDHJEJE LINK WIRE SET	3x1.5mm ²	1M	<input checked="" type="checkbox"/> AT antracit anthracite	
...	<input type="checkbox"/> ES e argjendtë elox elox silver	
...	<input type="checkbox"/> IW e bardhë fildishi ivory white	

SET PRIZASH 2x SCHUKO 2P+E 16 A 250 V~ 4M

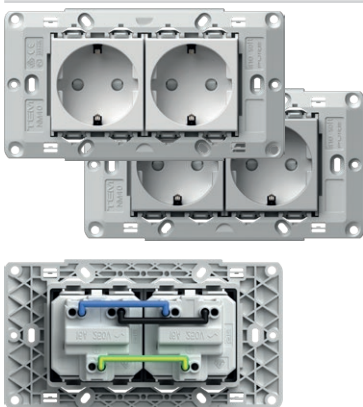

- CM10PW
- CM10ES

- set prizash 2x schuko VM10 2P+E 16 A 250 V~
- pajisur paraprakisht me lidhje telash CM16
- me kornizë montimi 4M pa vida
- për montimin e kornizës përdorni vida CM17, CM18 ose CM19
- kontaktet e vidave 1,5-2,5 mm²
- në përputhje me IEC 60884-1, CEE7

SOCKETS SET 2x SCHUKO 2P+E 16A 250V~ 4M

- socket set 2x schuko VM10 2P+E 16A 250V~
- prewired with link wires CM16
- with mounting frame 4M without screws
- for mounting frame fixing use screws CM17, CM18 or CM19
- screw contacts 1.5-2.5 mm²
- in accordance with IEC-60884-1, CEE7

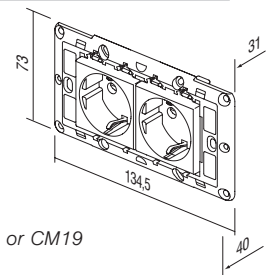

SET PRIZASH 3x SCHUKO 2P+E 16 A 250 V~ 7M

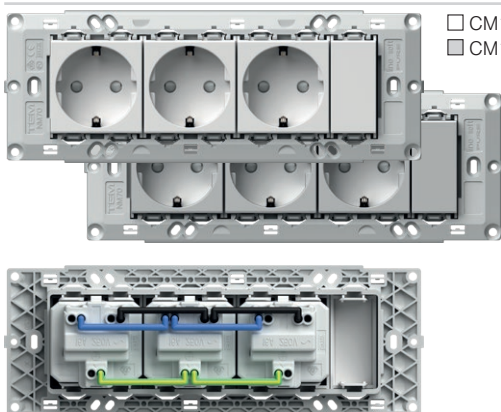

- CM11PW
- CM11ES

- set prizash 3x schuko VM10 2P+E 16 A 250 V~
- pajisur paraprakisht me lidhje telash CM16
- me kornizë montimi 7M pa vida
- për montimin e kornizës përdorni vida CM17, CM18 ose CM19
- kontaktet e vidave 1,5-2,5 mm²
- në përputhje me IEC 60884-1, CEE7

SOCKETS SET 3x SCHUKO 2P+E 16A 250V~ 7M

- socket set 3x schuko VM10 2P+E 16A 250V~
- prewired with link wires CM16
- with mounting frame 7M without screws
- for mounting frame fixing use screws CM17, CM18 or CM19
- screw contacts 1.5-2.5 mm²
- in accordance with IEC-60884-1, CEE7

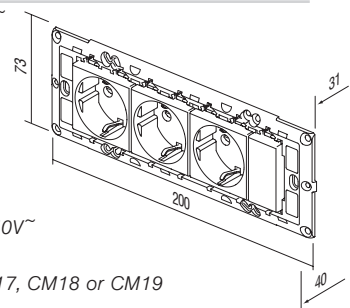

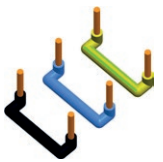

SET LIDHJEJE 3x1,5 mm² 1M

CM15

- set lidhjeje për të lidhur dy elemente madhësia 1M
- përfshin 10 tela të zi, 10 blu dhe 10 të verdhë/të gjelbër

LINK WIRE SET 3x1.5mm² 1M

- link wire set to connect two elements size 1M
- includes 10 black, 10 blue and 10 yellow/green wires

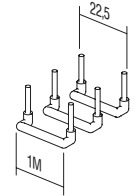

22,5
1M



SET LIDHJEJE 3x2,5 mm² 2M

CM16

- set lidhjeje për të lidhur dy elemente madhësia 2M
- përfshin 10 tela të zi, 10 blu dhe 10 të verdhë/të gjelbër

LINK WIRE SET 3x2.5mm² 2M

- link wire set to connect two elements size 2M
- includes 10 black, 10 blue and 10 yellow/green wires

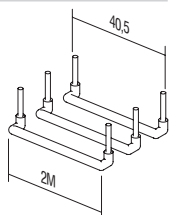

40,5
2M



SET VIDASH 3,5

CM17
CM18
CM19

- set vidash për fiksimin e kornizave të montimit
- NM30, NM32, NM40, NM41, NM70
- CM17 - l=20mm, 100 copë
- CM18 - l=35mm, 50 copë
- CM19 - l=50mm, 50 copë

SCREW SET 3,5

- screw set for fixing mounting frames NM30, NM32, NM40, NM41, NM70
- CM17 - l=20mm, 100pcs
- CM18 - l=35mm, 50pcs
- CM19 - l=50mm, 50pcs

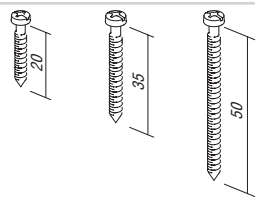

20
35
50



SET ÇELËSASH IP44 2M

CM22PW

- për përdorim në zona me lagështirë
- të gjithë çelësat Modul janë të pajisur me mbrojtje IP44
- çelësat dhe butonat nuk janë pjesë e setit
- kapak mbulues SOFT 2M me pllakë me mbishkrim
- në përputhje me IEC 60669-1

SET SWITCHES IP44 2M

- for usage in humid areas
- IP44 protection provides for all Modul switches
- switches and buttons are not part of the set
- SOFT 2M cover plate with inscription plate
- in accordance with IEC 60669-1





SET PRIZASH IP44 2M

CM23PW

- për përdorim në zona me lagështirë
- mbrojtja IP44 mund të arrihet vetëm në kombinim me prizën e mbuluar (VM11, VM41)
- prizat nuk janë pjesë e setit
- kapak mbulues SOFT 2M me pllakë me mbishkrim
- në përputhje me IEC 60884-1

SET SOCKETS IP44 2M

- for usage in humid areas
- IP44 protection can be achieved only in combination with covered socket (VM11, VM41)
- sockets are not part of the set
- SOFT 2M cover plate with inscription plate
- in accordance with IEC 60884-1



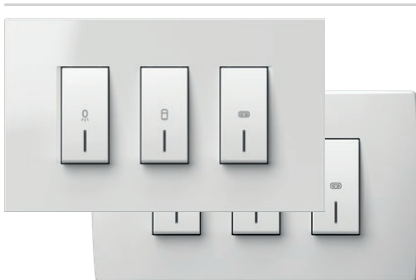

SET ÇELËSASH PËR BANJË 3x20 A 250 V~ 4M

CM25PWOL
 CM25IWOL

CM25PWOS
 CM25IWOS

- set çelësash 3xSM12 20 A 250 V~ me kornizë montimi dhe kapak mbulues
- kontaktet e vidave 1,5-2,5 mm²
- në përputhje me EN 60669-1
- zgjidhje universale për rinovimin e kutive me dimensione fikse 108-135 mm
- ose kuti madhësia 4M
- kapak mbulues lartësia 90 mm

SWITCH SET FOR BATHROOM 3x20A 250V~ 4M

- switch set 3xSM12 20A 250V~ with mounting frame and cover plate
- screw contacts 1.5-2.5mm²
- in accordance with EN 60669-1
- universal solution for renovation on boxes with fixing dimensions 108-135mm or boxes 4M size
- cover plate height 90mm



90
24
150-01
154-05
90

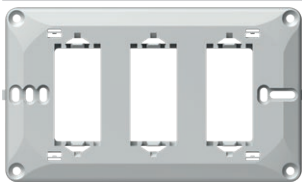

NM41





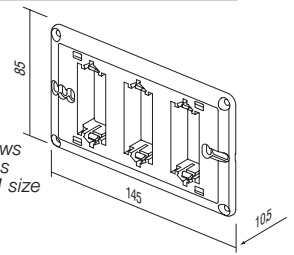

SET KORNIZË MONTIMI PËR BANJË 4M

- kornizë montimi universale për set banjë me vida
- zgjidhje universale për montimin në kutitë drejtkëndore me dimensione fikse 108-135 mm ose kuti madhësia 4M
- në përputhje me EN 60669-1

MOUNTING FRAME BATHROOM SET 4M

- universal mounting frame for bathroom set with screws
- universal solution for mounting on rectangular boxes with fixing dimensions 108-135mm or boxes 4M size
- in accordance with EN 60669-1



-  OL41PW
-  OL41NB
-  OL41IW
-  OL41ES
-  OL41SG
-  OL41IB

SETI KAPAKU MBULUES LINE PËR BANJË

- set dekorativ kapaku mbulues për banjë LINE
- lartësia 90 mm
- në përputhje me EN 60669-1

COVER PLATE LINE BATHROOM SET

- decorative cover plate bathroom set LINE
- height 90mm
- in accordance with EN 60669-1

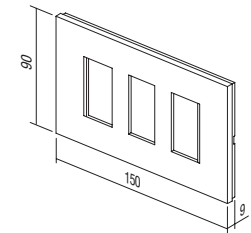

-  OS41PW
-  OS41NB
-  OS41IW
-  OS41ES
-  OS41SG
-  OS41SB
-  OS41WE

SETI KAPAKU MBULUES SOFT PËR BANJË



- set dekorativ kapaku mbulues për banjë SOFT
- lartësia 90 mm
- në përputhje me EN 60669-1

COVER PLATE SOFT BATHROOM SET

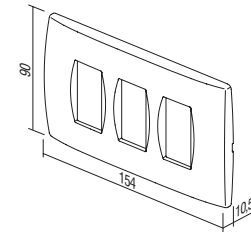
- decorative cover plate bathroom set SOFT
- height 90mm
- in accordance with EN 60669-1





Iloji type	përshkrimi description	madhësia size	ngjyra colour	të dhënat opsionale 1 optional data 1
TM11	BUTON BUTTON	1M	<input type="checkbox"/> AW e bardhë antibakteriale antibacterial white	 NT neutral neutral
TM21	FALSO BLANK	1M		
VM10	PRIZË SOCKET	2M		 IN treguesi indicator
.	.	.		
.	.	.		

PROGRAMI ANTIBAKTERIAL MODUL

- çelësat dhe prizat preken çdo ditë nga shumë njerëz, prandaj janë një vend i zakonshëm për zhvillimin dhe përhapjen e baktereve
- falë karakteristikave të veta natyrale, argjendi është përdorur për tremijë vjet si dezinfektues i sigurt dhe efikas, duke qenë se është plotësisht natyral, i shëndetshëm dhe miqësor për mjedisin
- jonet speciale antibakteriale të argjendit ofrojnë mbrojtje afatgjatë, të qëndrueshme dhe efektive kundër zhvillimit dhe përhapjes së baktereve, viruseve, mikrobeve dhe kërpudhave
- mbrojtja antibakteriale siguron higjienë, pastërti dhe shëndet për njerëzit
- programi antibakterial MODUL është plotësisht i përshtatshëm për përdorim në mjedise me kushte të rrepta higjienike (spitale, qendra shëndetësore, ambiente farmaceutike, azile pleqsh, laboratorë, restorante, hotele, aeroporte, stacione hekurudhore dhe autobusi, qendra biznesi dhe tregtare, institucione publike...)
- janë kryer teste të pavarura laboratorike në përputhje me standardet më të larta japoneze JIS Z 2801
- kosto e ulët për të siguruar shëndetin e njeriut
- dizajni dhe funksionimi i programit antibakterial MODUL lejon pastrim dhe mirëmbajtje të lehtë
- butonat antibakteriale, kapakët mbulues dhe prizat kombinohen me versione klasike të kornizave dhe çelësave
- produktet etiketohen në pjesën e pasme me AW (e bardhë antibakteriale)

ANTIBACTERIAL PROGRAM MODUL

- switches and sockets are daily touched by many people, so this is a common place for development and spread of bacteria
- thanks to its natural antibacterial characteristics silver has been used for three millennia as a safe and effective disinfectant, since it is completely natural, healthy and environmentally friendly
- special antibacterial silver ions additive provides long-term, reliable and effective protection against the development and spread of bacteria, viruses, microbes and fungi
- antibacterial protection ensures hygiene, cleanliness and health for people
- perfectly suitable for use in environments with strict hygiene conditions (hospitals, health centers, pharmaceutical facilities, homes for elderly, nursing homes, laboratories, restaurants, hotels, airports, bus and railway stations, business and shopping areas, public institutions ...)
- independent laboratory testings have been carried out in accordance with highest Japanese standards JIS Z 2801
- low cost for providing human health
- design and functionality of antibacterial program MODUL allow easy cleaning and maintenance
- antibacterial buttons, cover plates and sockets are combined with classic mounting frames and switches
- products are labelled on the back with AW (antibacterial white)

A N T I B A C T E R I A L P R O G R A M M O D U L

	□ TM11AW	<p>BUTON 1M</p> <ul style="list-style-type: none"> - buton i ndërrueshëm 1M - në përputhje me EN 60669-1 - mbrojtje antibakteriale në përputhje me standardin JIS Z 2801 <p><i>BUTTON 1M</i></p> <ul style="list-style-type: none"> - replaceable button 1M - in accordance with EN 60669-1 - antibacterial protection in accordance with JIS Z 2801 	
	□ TM11AWIN	<p>TREGUES BUTONI 1M</p> <ul style="list-style-type: none"> - buton i ndërrueshëm 1M - në përputhje me EN 60669-1 - mbrojtje antibakteriale në përputhje me standardin JIS Z 2801 <p><i>BUTTON 1M INDICATOR</i></p> <ul style="list-style-type: none"> - replaceable button 1M - in accordance with EN 60669-1 - antibacterial protection in accordance with JIS Z 2801 	
	□ TM12AW	<p>BUTON 2M</p> <ul style="list-style-type: none"> - buton i ndërrueshëm 2M me mbajtëse butoni - për të përditësuar çelësin ose butonin me shtypje nga madhësia 1M në madhësinë 2M - në përputhje me EN 60669-1 - mbrojtje antibakteriale në përputhje me standardin JIS Z 2801 <p><i>BUTTON 2M</i></p> <ul style="list-style-type: none"> - replaceable button 2M with button carrier - to upgrade switch or push button from size 1M to size 2M - in accordance with EN 60669-1 - antibacterial protection in accordance with JIS Z 2801 	
	□ TM12AWIN	<p>TREGUES BUTONI 2M</p> <ul style="list-style-type: none"> - buton i ndërrueshëm 2M me mbajtëse butoni - për të përditësuar çelësin ose butonin me shtypje nga madhësia 1M në madhësinë 2M - në përputhje me EN 60669-1 - mbrojtje antibakteriale në përputhje me standardin JIS Z 2801 <p><i>BUTTON 2M INDICATOR</i></p> <ul style="list-style-type: none"> - replaceable button 2M with button carrier - to upgrade switch or push button from size 1M to size 2M - in accordance with EN 60669-1 - antibacterial protection in accordance with JIS Z 2801 	
	□ TM21AW	<p>FALSO 1M</p> <ul style="list-style-type: none"> - modul falso për të mbushur hapësirat boshe - në përputhje me EN 60669-1 - mbrojtje antibakteriale në përputhje me standardin JIS Z 2801 <p><i>BLANK 1M</i></p> <ul style="list-style-type: none"> - blank modul to fill up empty spaces - in accordance with EN 60669-1 - antibacterial protection in accordance with JIS Z 2801 	
	□ TM22AW	<p>FALSO 2M</p> <ul style="list-style-type: none"> - modul falso për të mbushur hapësirat boshe - në përputhje me EN 60669-1 - mbrojtje antibakteriale në përputhje me standardin JIS Z 2801 <p><i>BLANK 2M</i></p> <ul style="list-style-type: none"> - blank modul to fill up empty spaces - in accordance with EN 60669-1 - antibacterial protection in accordance with JIS Z 2801 	



□ VM10AW

PRIZË SCHUKO+KS 2P+E 16 A 250 V~ 2M

- 2P+E schuko
- 16 A 250 V~, lloji VM10
- në përputhje me IEC 60884-1, CEE7
- kontaktet e vidave 1,5-2,5 mm²
- kontaktet me rrymën të mbuluara
- mbrojtje antibakteriale në përputhje me standardin JIS Z 2801

SOCKET SCHUKO+KS 2P+E 16A 250V~ 2M

- 2P+E schuko
- 16A 250V~, type VM10
- in accordance with IEC 60884-1, CEE7
- screw contacts 1.5-2.5 mm²
- shuttered live contacts
- antibacterial protection in accordance with JIS Z 2801



□ VM11AW

PRIZË SCHUKO+KS+KAPAK 2P+E 16 A 250 V~ 2M

- 2P+E schuko+kapak
- 16 A 250 V~, lloji VM11
- në përputhje me IEC 60884-1, CEE7
- kontaktet e vidave 1,5-2,5 mm²
- kontaktet me rrymën të mbuluara
- mbrojtje antibakteriale në përputhje me standardin JIS Z 2801

SOCKET SCHUKO+KS+COVER

- 2P+E schuko+cover
- 16A 250V~, type VM11
- in accordance with IEC 60884-1, CEE7
- screw contacts 1.5-2.5 mm²
- shuttered live contacts
- antibacterial protection in accordance with JIS Z 2801



□ VM20AW

PRIZË EURO+KS 2P 10A 250 V~ 1M

- 2P Euro
- 10A 250 V~, lloji VM20
- në përputhje me IEC 60884-1, CEE7
- kontaktet e vidave 1,5-2,5 mm²
- kontaktet me rrymën të mbuluara
- mbrojtje antibakteriale në përputhje me standardin JIS Z 2801

SOCKET EURO+KS 2P 10A 250V~ 1M

- 2P Euro
- 10A 250V~, type VM20
- in accordance with IEC 60884-1, CEE7
- screw contacts 1.5-2.5 mm²
- shuttered live contacts
- antibacterial protection in accordance with JIS Z 2801



□ KM11AW

PRIZË TV ME KAPAK FUNDOR 1dB 1M

- TV me kapak fundor
- gama e frekuencës 5÷2400 MHz
- reduktimi < 1 dB
- në përputhje me EN 50083-1
- kontaktet e vidave
- mbrojtje antibakteriale në përputhje me standardin JIS Z 2801

SOCKET TV END-LINE 1dB 1M

- TV end-line
- frequency range 5÷2400 MHz
- reduction < 1 dB
- in accordance with EN 50083-1
- screw contacts
- antibacterial protection in accordance with JIS Z 2801

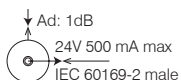

□ KM35AW

PËRSHTATËS KS 1M

- standard fiksues trapez KS
- AMP, Avaya, Brandrex, FMT, Mfico, Tyco, ...
- moduli i komunikimit nuk përfshihet
- mbrojtje antibakteriale në përputhje me standardin JIS Z 2801

ADAPTER KS 1M

- KS keystone fixing standard
- AMP, Avaya, Brandrex, FMT, Mfico, Tyco, ...
- communication module not included
- antibacterial protection in accordance with JIS Z 2801



A N T I B A C T E R I A L P R O G R A M M O D U L



OS20AW

KAPAK MBULUES SOFT 2M

- kapak mbulues dekorativ SOFT 2M
- në përputhje me EN 60669-1
- mbrojtje antibakteriale në përputhje me standardin JIS Z 2801

COVER PLATE SOFT 2M

- decorative cover plate SOFT 2M
- in accordance with EN 60669-1
- antibacterial protection in accordance with JIS Z 2801



OS24AW

KAPAK MBULUES SOFT 2x2M

- kapak mbulues dekorativ SOFT 2x2M
- montim horizontal ose vertikal
- në përputhje me EN 60669-1
- mbrojtje antibakteriale në përputhje me standardin JIS Z 2801

COVER PLATE SOFT 2x2M

- decorative cover plate SOFT 2x2M
- horizontal or vertical mounting
- in accordance with EN 60669-1
- antibacterial protection in accordance with JIS Z 2801



OS26AW

KAPAK MBULUES SOFT 3x2M

- kapak mbulues dekorativ SOFT 3x2M
- montim horizontal ose vertikal
- në përputhje me EN 60669-1
- mbrojtje antibakteriale në përputhje me standardin JIS Z 2801

COVER PLATE SOFT 3x2M

- decorative cover plate SOFT 3x2M
- horizontal or vertical mounting
- in accordance with EN 60669-1
- antibacterial protection in accordance with JIS Z 2801



OS30AW

KAPAK MBULUES SOFT 3M

- kapak mbulues dekorativ SOFT 3M
- në përputhje me EN 60669-1
- mbrojtje antibakteriale në përputhje me standardin JIS Z 2801

COVER PLATE SOFT 3M

- decorative cover plate SOFT 3M
- in accordance with EN 60669-1
- antibacterial protection in accordance with JIS Z 2801



OS40AW

KAPAK MBULUES SOFT 4M

- kapak mbulues dekorativ SOFT 4M
- në përputhje me EN 60669-1
- mbrojtje antibakteriale në përputhje me standardin JIS Z 2801

COVER PLATE SOFT 4M

- decorative cover plate SOFT 4M
- in accordance with EN 60669-1
- antibacterial protection in accordance with JIS Z 2801

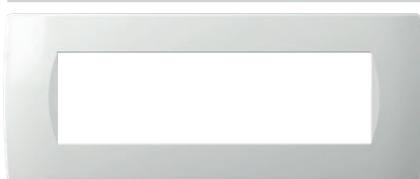

OS70AW

KAPAK MBULUES SOFT 7M

- kapak mbulues dekorativ SOFT 7M
- në përputhje me EN 60669-1
- mbrojtje antibakteriale në përputhje me standardin JIS Z 2801

COVER PLATE SOFT 7M

- decorative cover plate SOFT 7M
- in accordance with EN 60669-1
- antibacterial protection in accordance with JIS Z 2801

dru
wood

WB bambu
bamboo



WW arrë
walnut



WM panjë
maple



WE venge
wenge



Natyra është unike dhe e çmuar, sepse kapakët tanë mbulues dekorativë nuk janë dy njësoj.
Nuk mund të konsiderohen ankesat rreth pamjes diverse dhe ndryshimeve të kapakëve dekorativë prej druri.

Nature is unique and precious, as our decorative cover plates where no two are the same.
Complaints about wooden decorative cover plate's diverse appearance and differentiation cannot be considered.

COVER PLATES PURE OP

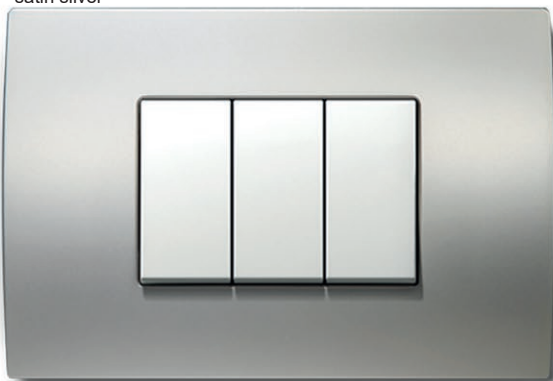
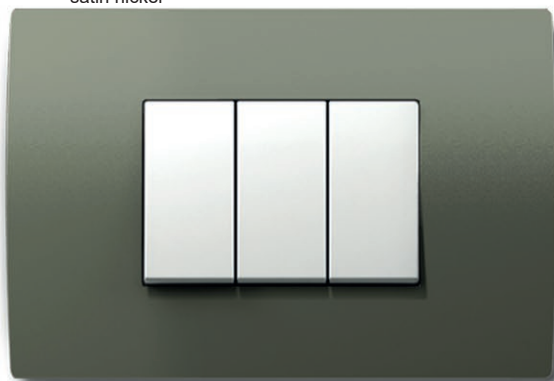
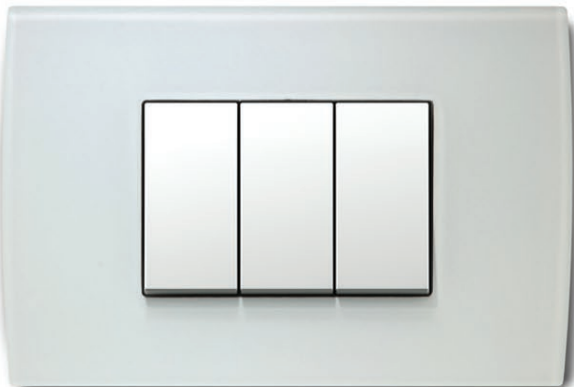
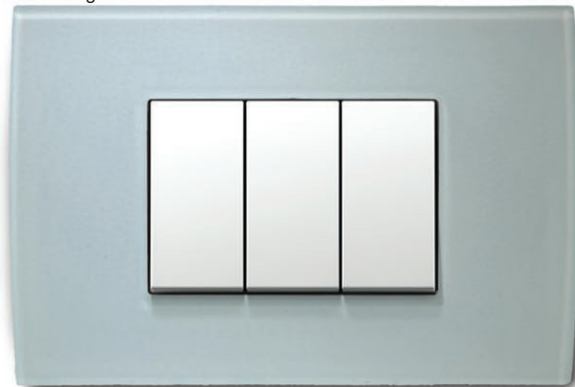
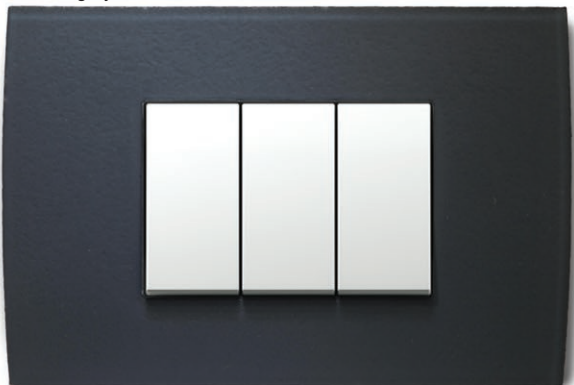
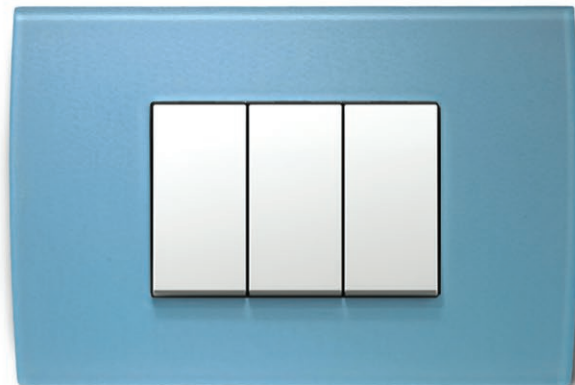
metal
metalMH çelik i rrahur
hammered steelME hekur i ngrënë
etched ironMS argjend satin
satin silverMN nikel satin
satin nickelxham
glassGW e bardhë akulli
ice whiteGG e gjelbër akulli
ice greenGY gri akulli
ice greyGB blu akulli
ice blue



OP30

WB

Iloji type	përshkrimi description	madhësia size	ngjyra colour	
OP13	KAPAK MBULUES PURE COVER PLATE PURE	1/3M	MH çelik i rrahur hammered steel	WB bambo
OP20	KAPAK MBULUES PURE COVER PLATE PURE	2M	ME hekur i ngrënë etched iron	WW arrë walnut
OP23	KAPAK MBULUES PURE COVER PLATE PURE	2/3M	MS argjend satin satin silver	WM panjë maple
.	.	.	MN nikel satin satin nickel	WE venge wenge
.	.	.	GW e bardhë akulli ice white	GG e gjelbër akulli ice green
.	.	.	GY gri akulli ice grey	GB blu akulli ice blue



OP20MH	OP20WB
OP20ME	OP20WW
OP20MS	OP20WM
OP20MN	OP20WE
	OP20GW
	OP20GG
	OP20GY
	OP20GB

KAPAK MBULUES PURE 2M

- kapak mbulues dekorativ PURE 2M
- në përputhje me EN 60669-1
- vetëm në kombinim me kornizë montimi NM24 ose NM25

COVER PLATE PURE 2M

- decorative cover plate PURE 2M
- in accordance with EN 60669-1
- only in combination with mounting frames NM24 or NM25



OP24MH	OP24WB
OP24ME	OP24WW
OP24MS	OP24WM
OP24MN	OP24WE
	OP24GW
	OP24GG
	OP24GY
	OP24GB

KAPAK MBULUES PURE 2x2M

- kapak mbulues dekorativ PURE 2x2M
- montim horizontal ose vertikal
- në përputhje me EN 60669-1
- vetëm në kombinim me kornizë montimi NM24 ose NM25

COVER PLATE PURE 2x2M

- decorative cover plate PURE 2x2M
- horizontal or vertical mounting
- in accordance with EN 60669-1
- only in combination with mounting frames NM24 or NM25



OP26MH	OP26WB
OP26ME	OP26WW
OP26MS	OP26WM
OP26MN	OP26WE
	OP26GW
	OP26GG
	OP26GY
	OP26GB

KAPAK MBULUES PURE 3x2M

- kapak mbulues dekorativ PURE 3x2M
- montim horizontal ose vertikal
- në përputhje me EN 60669-1
- vetëm në kombinim me kornizë montimi NM24 ose NM25

COVER PLATE PURE 3x2M

- decorative cover plate PURE 3x2M
- horizontal or vertical mounting
- in accordance with EN 60669-1
- only in combination with mounting frames NM24 or NM25

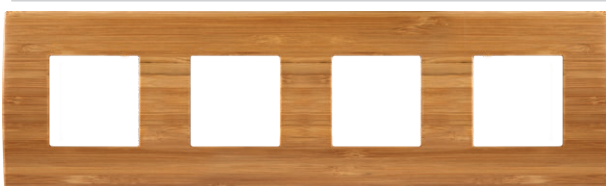

OP28MH	OP28WB
OP28ME	OP28WW
OP28MS	OP28WM
OP28MN	OP28WE
	OP28GW
	OP28GG
	OP28GY
	OP28GB

KAPAK MBULUES PURE 4x2M

- kapak mbulues dekorativ PURE 4x2M
- montim horizontal ose vertikal
- në përputhje me EN 60669-1
- vetëm në kombinim me kornizë montimi NM24 ose NM25

COVER PLATE PURE 4x2M

- decorative cover plate PURE 4x2M
- horizontal or vertical mounting
- in accordance with EN 60669-1
- only in combination with mounting frames NM24 or NM25

COVER PLATES PURE OP



	OP30MH		OP30WB
	OP30ME		OP30WW
	OP30MS		OP30WM
	OP30MN		OP30WE
			OP30GW
			OP30GG
			OP30GY
			OP30GB

KAPAK MBULUES PURE 3M

- kapak mbulues dekorativ PURE 3M
- në përputhje me EN 60669-1

COVER PLATE PURE 3M

- decorative cover plate PURE 3M
- in accordance with EN 60669-1



	OP40MH		OP40WB
	OP40ME		OP40WW
	OP40MS		OP40WM
	OP40MN		OP40WE
			OP40GW
			OP40GG
			OP40GY
			OP40GB

KAPAK MBULUES PURE 4M

- kapak mbulues dekorativ PURE 4M
- në përputhje me EN 60669-1

COVER PLATE PURE 4M

- decorative cover plate PURE 4M
- in accordance with EN 60669-1



	OP70MH		OP70WB
	OP70ME		OP70WW
	OP70MS		OP70WM
	OP70MN		OP70WE
			OP70GW
			OP70GG
			OP70GY
			OP70GB

KAPAK MBULUES PURE 7M

- kapak mbulues dekorativ PURE 7M
- në përputhje me EN 60669-1

COVER PLATE PURE 7M

- decorative cover plate PURE 7M
- in accordance with EN 60669-1



	OP13MH		OP13WB
	OP13ME		OP13WW
	OP13MS		OP13WM
	OP13MN		OP13WE
			OP13GW
			OP13GG
			OP13GY
			OP13GB

KAPAK MBULUES PURE 1/3M

- kapak mbulues dekorativ PURE 1/3M
- në përputhje me EN 60669-1

COVER PLATE PURE 1/3M

- decorative cover plate PURE 1/3M
- in accordance with EN 60669-1



	OP23MH		OP23WB
	OP23ME		OP23WW
	OP23MS		OP23WM
	OP23MN		OP23WE
			OP23GW
			OP23GG
			OP23GY
			OP23GB

KAPAK MBULUES PURE 2/3M

- kapak mbulues dekorativ PURE 2/3M
- në përputhje me EN 60669-1

COVER PLATE PURE 2/3M

- decorative cover plate PURE 2/3M
- in accordance with EN 60669-1

bazë
basic

PW e bardhë polare
polar white

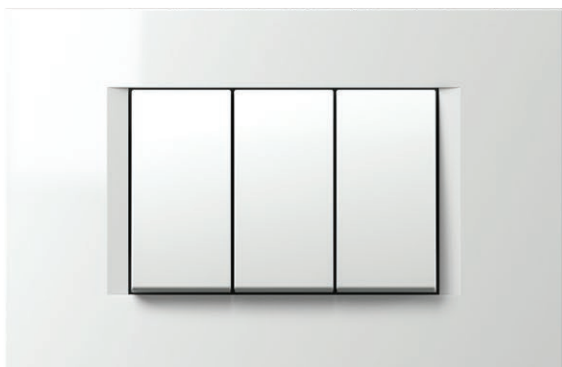

IW e bardhë fildishi
ivory white

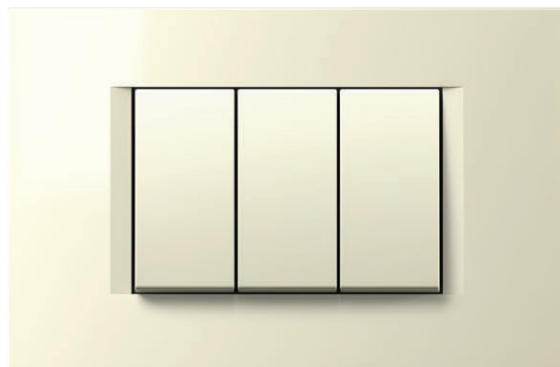

ES e argjendtë elox
elox silver



SB e zezë soft touch
soft touch black

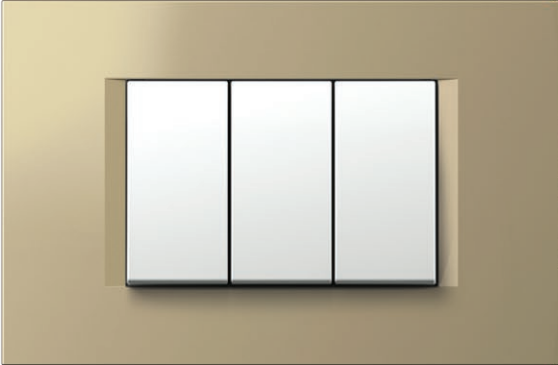
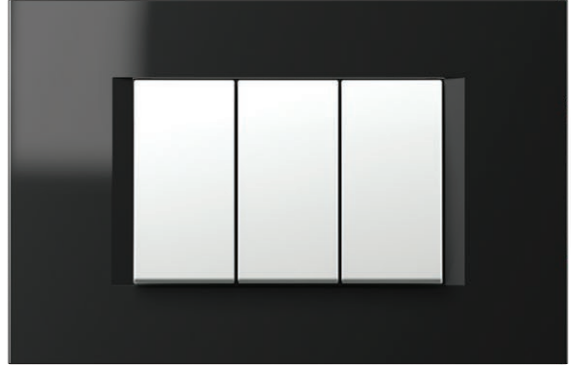
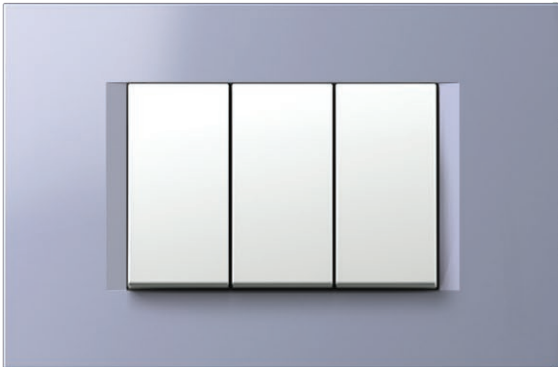
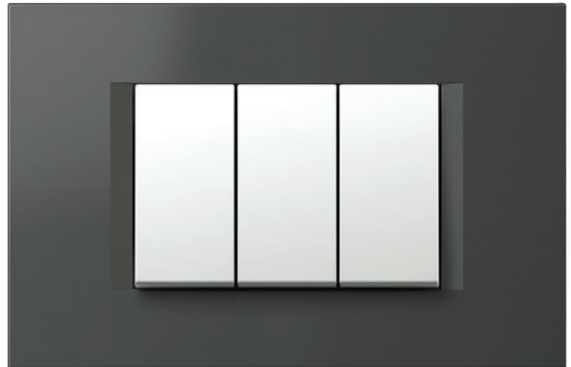
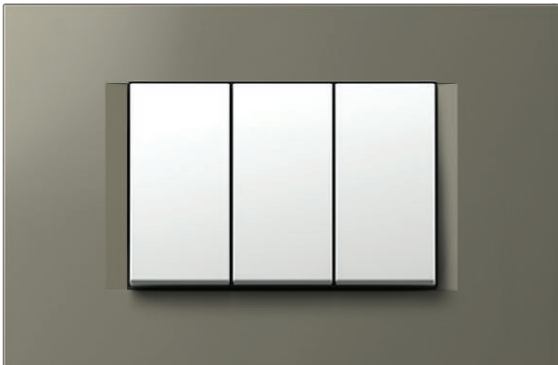

C O V E R P L A T E S L I N E O L

dekor
decorSG e artë ranore
sand goldNB e zezë mesnate
night blackIB Impuls blu
impulse blueAT antracit
anthraciteTI titan
titaniumSW e bardhë guri
stone white

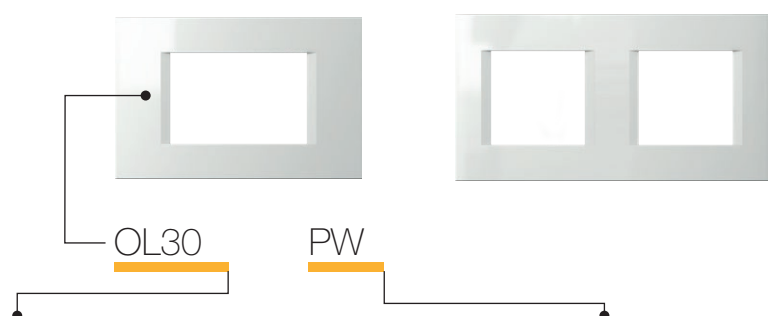

Iloji type	përshkrimi description	madhësia size	ngjyra colour												
OL10	KAPAK MBULUES LINE COVER PLATE LINE	1/2M	<table border="0"> <tr> <td></td> <td>PW e bardhë polare polar white</td> <td></td> <td>SG e artë ranore sand gold</td> <td></td> <td>AT antracit anthracite</td> </tr> </table>		PW e bardhë polare polar white		SG e artë ranore sand gold		AT antracit anthracite						
	PW e bardhë polare polar white		SG e artë ranore sand gold		AT antracit anthracite										
OL13	KAPAK MBULUES LINE COVER PLATE LINE	1/3M	<table border="0"> <tr> <td></td> <td>IW e bardhë fildishi ivory white</td> <td></td> <td>NB e zezë mesnate night black</td> <td></td> <td>TI titan titanium</td> </tr> </table>		IW e bardhë fildishi ivory white		NB e zezë mesnate night black		TI titan titanium						
	IW e bardhë fildishi ivory white		NB e zezë mesnate night black		TI titan titanium										
OL20	KAPAK MBULUES LINE COVER PLATE LINE	2M	<table border="0"> <tr> <td></td> <td>ES e argjendtë elox elox silver</td> <td></td> <td>IB Impuls blu impulse blue</td> <td></td> <td>SW e bardhë guri stone white</td> </tr> <tr> <td></td> <td>SB e zezë soft touch soft touch black</td> <td></td> <td></td> <td></td> <td></td> </tr> </table>		ES e argjendtë elox elox silver		IB Impuls blu impulse blue		SW e bardhë guri stone white		SB e zezë soft touch soft touch black				
	ES e argjendtë elox elox silver		IB Impuls blu impulse blue		SW e bardhë guri stone white										
	SB e zezë soft touch soft touch black														



KAPAK MBULUES LINE 2M

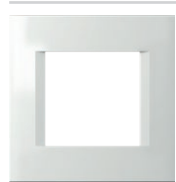

- | | | | |
|--|--------|--|--------|
| | OL20PW | | OL20SG |
| | OL20IW | | OL20NB |
| | OL20ES | | OL20IB |
| | OL20SB | | OL20AT |
| | | | OL20TI |
| | | | OL20SW |

- kapak mbulues dekorativ LINE 2M
 - në përputhje me EN 60669-1
COVER PLATE LINE 2M
 - decorative cover plate LINE 2M
 - in accordance with EN 60669-1

KAPAK MBULUES LINE 2x2M



- | | | | |
|--|--------|--|--------|
| | OL24PW | | OL24SG |
| | OL24IW | | OL24NB |
| | OL24ES | | OL24IB |
| | OL24SB | | OL24AT |
| | | | OL24TI |
| | | | OL24SW |

- kapak mbulues dekorativ LINE 2x2M
 - montim horizontal ose vertikal
 - në përputhje me EN 60669-1
COVER PLATE LINE 2x2M
 - decorative cover plate LINE 2x2M
 - horizontal or vertical mounting
 - in accordance with EN 60669-1

KAPAK MBULUES LINE 3x2M

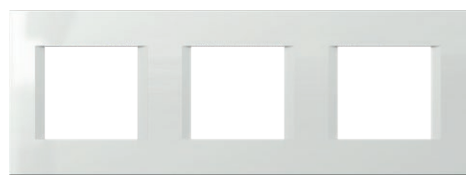

- | | | | |
|--|--------|--|--------|
| | OL26PW | | OL26SG |
| | OL26IW | | OL26NB |
| | OL26ES | | OL26IB |
| | OL26SB | | OL26AT |
| | | | OL26TI |
| | | | OL26SW |

- kapak mbulues dekorativ LINE 3x2M
 - montim horizontal ose vertikal
 - në përputhje me EN 60669-1
COVER PLATE LINE 3x2M
 - decorative cover plate LINE 3x2M
 - horizontal or vertical mounting
 - in accordance with EN 60669-1

KAPAK MBULUES LINE 4x2M



- | | | | |
|--|--------|--|--------|
| | OL28PW | | OL28SG |
| | OL28IW | | OL28NB |
| | OL28ES | | OL28IB |
| | OL28SB | | OL28AT |
| | | | OL28TI |
| | | | OL28SW |

- kapak mbulues dekorativ LINE 4x2M
 - montim horizontal ose vertikal
 - në përputhje me EN 60669-1
COVER PLATE LINE 4x2M
 - decorative cover plate LINE 4x2M
 - horizontal or vertical mounting
 - in accordance with EN 60669-1

KAPAK MBULUES LINE 5x2M

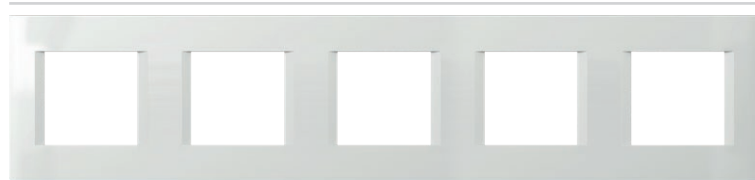





- | | |
|--|--------|
| | OL29PW |
| | OL29IW |
| | OL29ES |
| | OL29SB |
| | OL29AT |
| | OL29TI |

- kapak mbulues dekorativ LINE 5x2M
 - montim horizontal ose vertikal
 - në përputhje me EN 60669-1
COVER PLATE LINE 5x2M
 - decorative cover plate LINE 5x2M
 - horizontal or vertical mounting
 - in accordance with EN 60669-1

COVER PLATES LINE OL



 OL30PW	 OL30SG
 OL30IW	 OL30NB
 OL30ES	 OL30IB
 OL30SB	 OL30AT
	 OL30TI
	 OL30SW











KAPAK MBULUES LINE 3M

- kapak mbulues dekorativ LINE 3M
- në përputhje me EN 60669-1

COVER PLATE LINE 3M

- decorative cover plate LINE 3M
- in accordance with EN 60669-1



 OL40PW	 OL40SG
 OL40IW	 OL40NB
 OL40ES	 OL40IB
 OL40SB	 OL40AT
	 OL40TI
	 OL40SW

KAPAK MBULUES LINE 4M

- kapak mbulues dekorativ LINE 4M
- në përputhje me EN 60669-1

COVER PLATE LINE 4M

- decorative cover plate LINE 4M
- in accordance with EN 60669-1

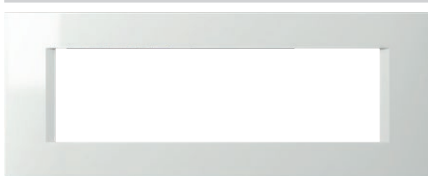

 OL70PW	 OL70SG
 OL70IW	 OL70NB
 OL70ES	 OL70IB
 OL70SB	 OL70AT
	 OL70TI
	 OL70SW

KAPAK MBULUES LINE 7M

- kapak mbulues dekorativ LINE 7M
- në përputhje me EN 60669-1

COVER PLATE LINE 7M

- decorative cover plate LINE 7M
- in accordance with EN 60669-1



 OL10PW	 OL10SG
 OL10IW	 OL10NB
 OL10ES	 OL10IB
 OL10SB	 OL10AT
	 OL10TI
	 OL10SW

KAPAK MBULUES LINE 1/2M

- kapak mbulues dekorativ LINE 1/2M
- në përputhje me EN 60669-1

COVER PLATE LINE 1/2M

- decorative cover plate LINE 1/2M
- in accordance with EN 60669-1

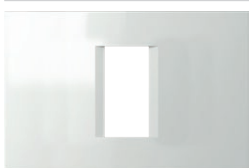

 OL13PW	 OL13SG
 OL13IW	 OL13NB
 OL13ES	 OL13IB
 OL13SB	 OL13AT
	 OL13TI
	 OL13SW











KAPAK MBULUES LINE 1/3M

- kapak mbulues dekorativ LINE 1/3M
- në përputhje me EN 60669-1

COVER PLATE LINE 1/3M

- decorative cover plate LINE 1/3M
- in accordance with EN 60669-1



 OL23PW	 OL23SG
 OL23IW	 OL23NB
 OL23ES	 OL23IB
 OL23SB	 OL23AT
	 OL23TI
	 OL23SW

KAPAK MBULUES LINE 2/3M

- kapak mbulues dekorativ LINE 2/3M
- në përputhje me EN 60669-1

COVER PLATE LINE 2/3M

- decorative cover plate LINE 2/3M
- in accordance with EN 60669-1

bazë
basic

PW e bardhë polare
polar white

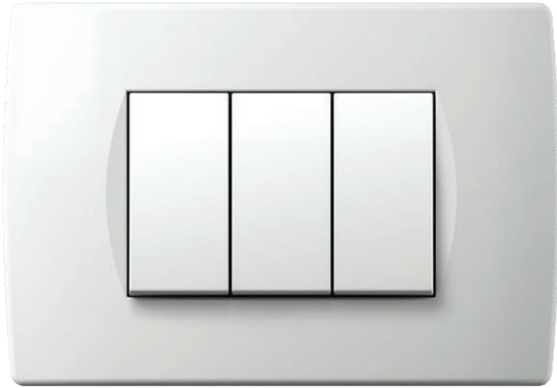

IW e bardhë fildishi
ivory white

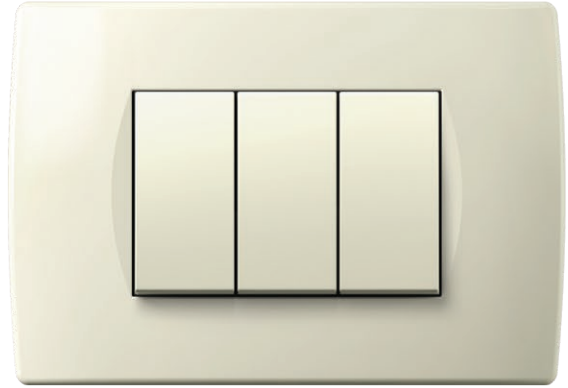

ES e argjendtë elox
elox silver

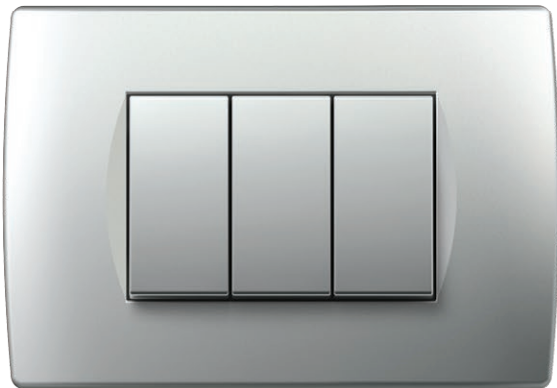

SB e zezë soft touch
soft touch black

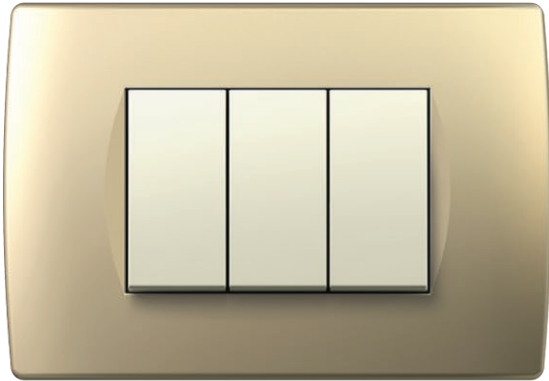
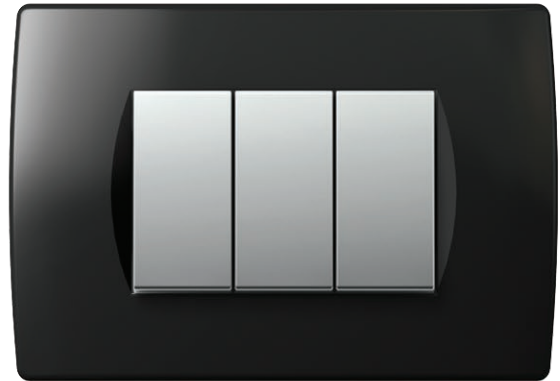
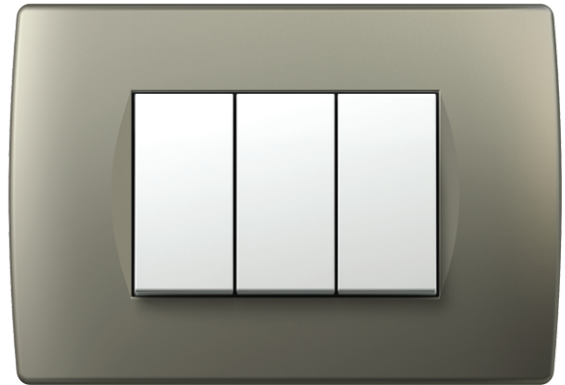
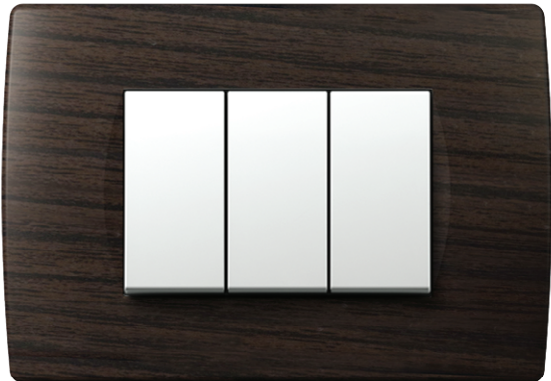

COVER PLATES SOFT OS

dekor
decorSG e artë ranore
sand goldNB e zezë mesnate
night blackAT antracit
anthraciteTI titan
titaniumWE venge
wengeWW arrë
walnut



OS30

PW

lloji type	përshkrimi description	madhësia size	ngjyra colour												
OS10	KAPAK MBULUES SOFT COVER PLATE SOFT	1/2M	<table border="0"> <tr> <td></td> <td>PW e bardhë polare polar white</td> <td></td> <td>SG e artë ranore sand gold</td> <td></td> <td>WW arrë walnut</td> </tr> </table>		PW e bardhë polare polar white		SG e artë ranore sand gold		WW arrë walnut						
	PW e bardhë polare polar white		SG e artë ranore sand gold		WW arrë walnut										
OS13	KAPAK MBULUES SOFT COVER PLATE SOFT	1/3M	<table border="0"> <tr> <td></td> <td>IW e bardhë fildishi ivory white</td> <td></td> <td>NB e zezë mesnate night black</td> <td></td> <td>WE venge venge</td> </tr> </table>		IW e bardhë fildishi ivory white		NB e zezë mesnate night black		WE venge venge						
	IW e bardhë fildishi ivory white		NB e zezë mesnate night black		WE venge venge										
OS20	KAPAK MBULUES SOFT COVER PLATE SOFT	2M	<table border="0"> <tr> <td></td> <td>ES e argjendtë elox elox silver</td> <td></td> <td>AT antracit anthracite</td> <td></td> <td></td> </tr> <tr> <td></td> <td>SB e zezë soft touch soft touch black</td> <td></td> <td>TI titan titanium</td> <td></td> <td></td> </tr> </table>		ES e argjendtë elox elox silver		AT antracit anthracite				SB e zezë soft touch soft touch black		TI titan titanium		
	ES e argjendtë elox elox silver		AT antracit anthracite												
	SB e zezë soft touch soft touch black		TI titan titanium												
...												



	OS20PW		OS20SG
	OS20IW		OS20NB
	OS20ES		OS20AT
	OS20SB		OS20TI
			OS20WW
			OS20WE

KAPAK MBULUES SOFT 2M
 - kapak mbulues dekorativ SOFT 2M
 - në përputhje me EN 60669-1
COVER PLATE SOFT 2M
 - decorative cover plate SOFT 2M
 - in accordance with EN 60669-1



	OS24PW		OS24SG
	OS24IW		OS24NB
	OS24ES		OS24AT
	OS24SB		OS24TI
			OS24WW
			OS24WE

KAPAK MBULUES SOFT 2x2M
 - kapak mbulues dekorativ SOFT 2x2M
 - montim horizontal ose vertikal
 - në përputhje me EN 60669-1
COVER PLATE SOFT 2x2M
 - decorative cover plate SOFT 2x2M
 - horizontal or vertical mounting
 - in accordance with EN 60669-1



	OS26PW		OS26SG
	OS26IW		OS26NB
	OS26ES		OS26AT
	OS26SB		OS26TI
			OS26WW
			OS26WE

KAPAK MBULUES SOFT 3x2M
 - kapak mbulues dekorativ SOFT 3x2M
 - montim horizontal ose vertikal
 - në përputhje me EN 60669-1
COVER PLATE SOFT 3x2M
 - decorative cover plate SOFT 3x2M
 - horizontal or vertical mounting
 - in accordance with EN 60669-1



	OS28PW		OS28SG
	OS28IW		OS28NB
	OS28ES		OS28AT
	OS28SB		OS28TI
			OS28WW
			OS28WE

KAPAK MBULUES SOFT 4x2M
 - kapak mbulues dekorativ SOFT 4x2M
 - montim horizontal ose vertikal
 - në përputhje me EN 60669-1
COVER PLATE SOFT 4x2M
 - decorative cover plate SOFT 4x2M
 - horizontal or vertical mounting
 - in accordance with EN 60669-1

COVER PLATES SOFT OS



 OS30PW	 OS30SG
 OS30IW	 OS30NB
 OS30ES	 OS30AT
 OS30SB	 OS30TI
	 OS30WW
	 OS30WE



KAPAK MBULUES SOFT 3M

- kapak mbulues dekorativ SOFT 3M
- në përputhje me EN 60669-1

COVER PLATE SOFT 3M

- decorative cover plate SOFT 3M
- in accordance with EN 60669-1



 OS40PW	 OS40SG
 OS40IW	 OS40NB
 OS40ES	 OS40AT
 OS40SB	 OS40TI
	 OS40WW
	 OS40WE





KAPAK MBULUES SOFT 4M

- kapak mbulues dekorativ SOFT 4M
- në përputhje me EN 60669-1

COVER PLATE SOFT 4M

- decorative cover plate SOFT 4M
- in accordance with EN 60669-1



 OS70PW	 OS70SG
 OS70IW	 OS70NB
 OS70ES	 OS70AT
 OS70SB	 OS70TI
	 OS70WW
	 OS70WE



KAPAK MBULUES SOFT 7M

- kapak mbulues dekorativ SOFT 7M
- në përputhje me EN 60669-1

COVER PLATE SOFT 7M

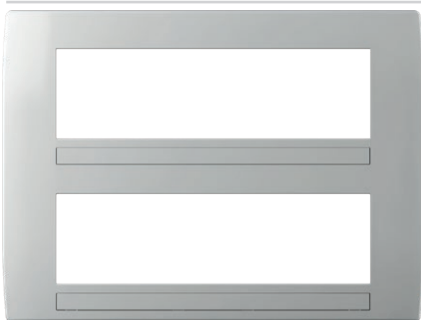
- decorative cover plate SOFT 7M
- in accordance with EN 60669-1



 OS72PW	 OS72AT
 OS72IW	 OS72TI
 OS72ES	
 OS72SB	

KAPAK MBULUES SOFT 2x7M

- kapak mbulues dekorativ SOFT 7x2M
me pllakë me mbishkrim
- në përputhje me EN 60669-1

COVER PLATE SOFT 2x7M

- decorative cover plate SOFT 2x7M
with inscription plate
- in accordance with EN 60669-1



 OS10PW	 OS10SG
 OS10IW	 OS10NB
 OS10ES	 OS10AT
 OS10SB	 OS10TI
	 OS10WW
	 OS10WE









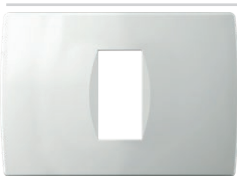

KAPAK MBULUES SOFT 1/2M

- kapak mbulues dekorativ SOFT 1/2M
- në përputhje me EN 60669-1

COVER PLATE SOFT 1/2M

- decorative cover plate SOFT 1/2M
- in accordance with EN 60669-1



 OS13PW	 OS13SG
 OS13IW	 OS13NB
 OS13ES	 OS13AT
 OS13SB	 OS13TI
	 OS13WW
	 OS13WE



KAPAK MBULUES SOFT 1/3M

- kapak mbulues dekorativ SOFT 1/3M
- në përputhje me EN 60669-1

COVER PLATE SOFT 1/3M

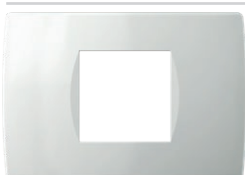
- decorative cover plate SOFT 1/3M
- in accordance with EN 60669-1



 OS23PW	 OS23SG
 OS23IW	 OS23NB
 OS23ES	 OS23AT
 OS23SB	 OS23TI
	 OS23WW
	 OS23WE

KAPAK MBULUES SOFT 2/3M

- kapak mbulues dekorativ SOFT 2/3M
- në përputhje me EN 60669-1

COVER PLATE SOFT 2/3M

- decorative cover plate SOFT 2/3M
- in accordance with EN 60669-1

PRINTIMIT ME LAZER MBI KAPAKËT MBULUES



- printim me lazer i çdo grafike
- prodhuar sipas kërkesës
- i përshtatshëm për kapakët mbulues OL, OS

LASER PRINT ON COVER PLATES

- laser print of any graphics
- made on request
- suitable for cover plates OL, OS

ZBUKURIMET E KAPAKËVE MBULUES





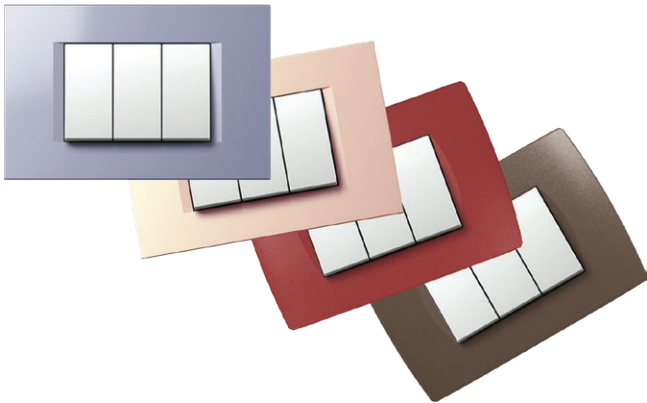

- tekstura dhe ngjyra të personalizuar
- prodhuar sipas kërkesës
- i përshtatshëm për kapakët mbulues OL, OS

COVER PLATES DECORATIONS

- customised textures and colours
- made on request
- suitable for cover plates OL, OS

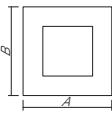
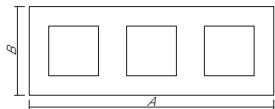
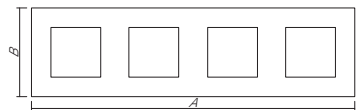
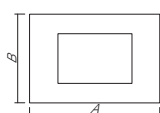
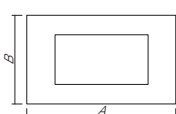
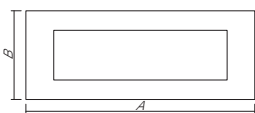
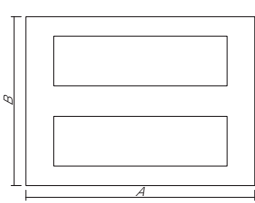

F R A M E S

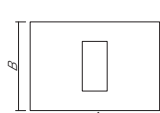
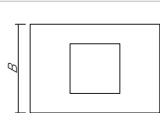
	 line A x B	 soft A x B	 PURE A x B
2M 	80 x 80 mm	84 x 84 mm	93 x 90 mm
2x2M 	151 x 80 mm	155 x 84 mm	164 x 90 mm
3x2M 	222 x 80 mm	226 x 84 mm	235 x 90 mm
4x2M 	293 x 80 mm	297 x 84 mm	304 x 90 mm
 3M 	122 x 80 mm	122 x 84 mm	134 x 90 mm
4M 	149 x 80 mm	144 x 84 mm	157 x 90 mm
7M 	207 x 80 mm	212 x 84 mm	224 x 90 mm
2x7M 		212 x 158 mm	
 1/2M 	80 x 80 mm	84 x 84 mm	
1/3M 	122 x 80 mm	122 x 84 mm	134 x 90 mm
2/3M 	122 x 80 mm	122 x 84 mm	134 x 90 mm

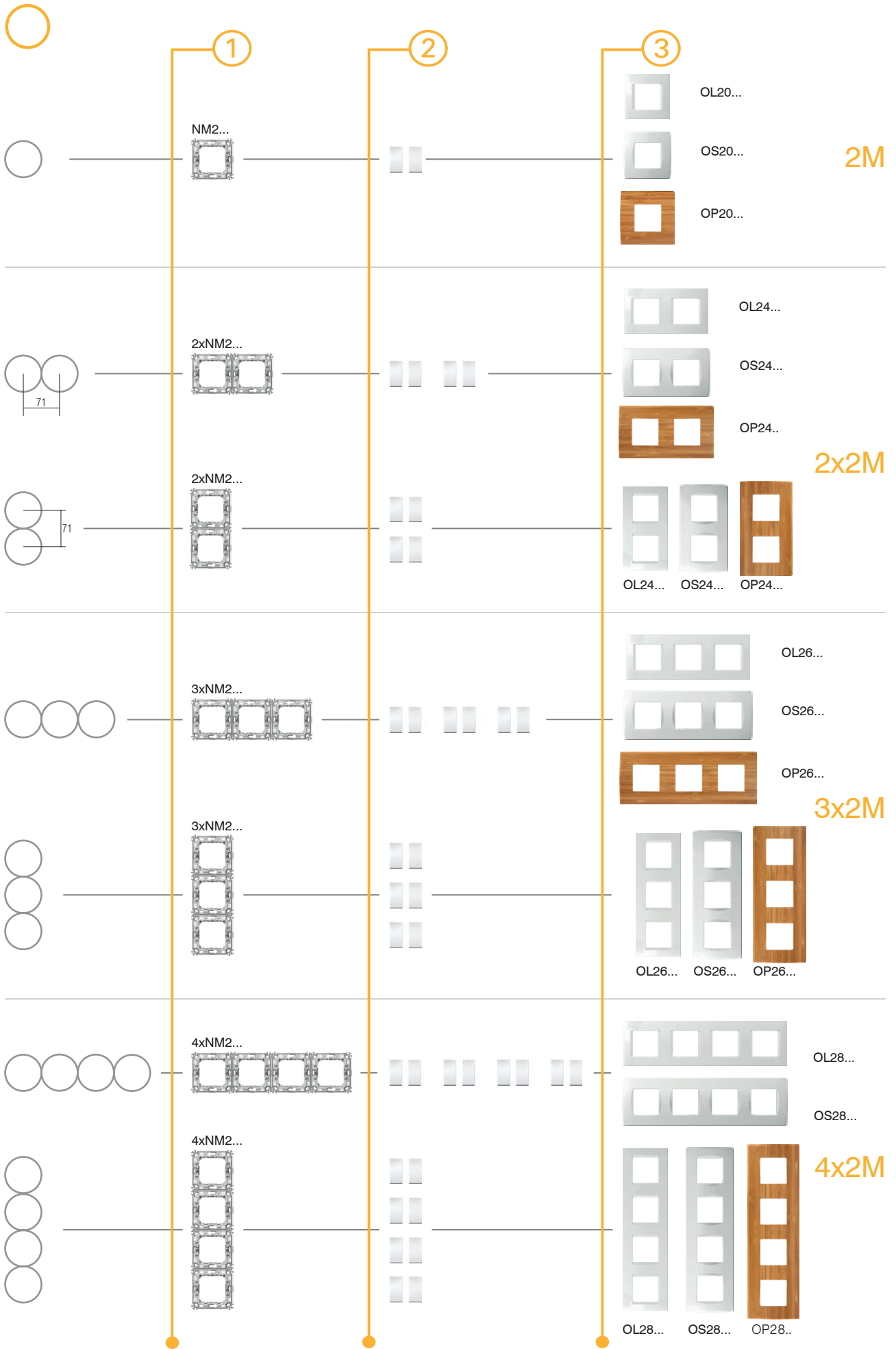

COMBINATIONS

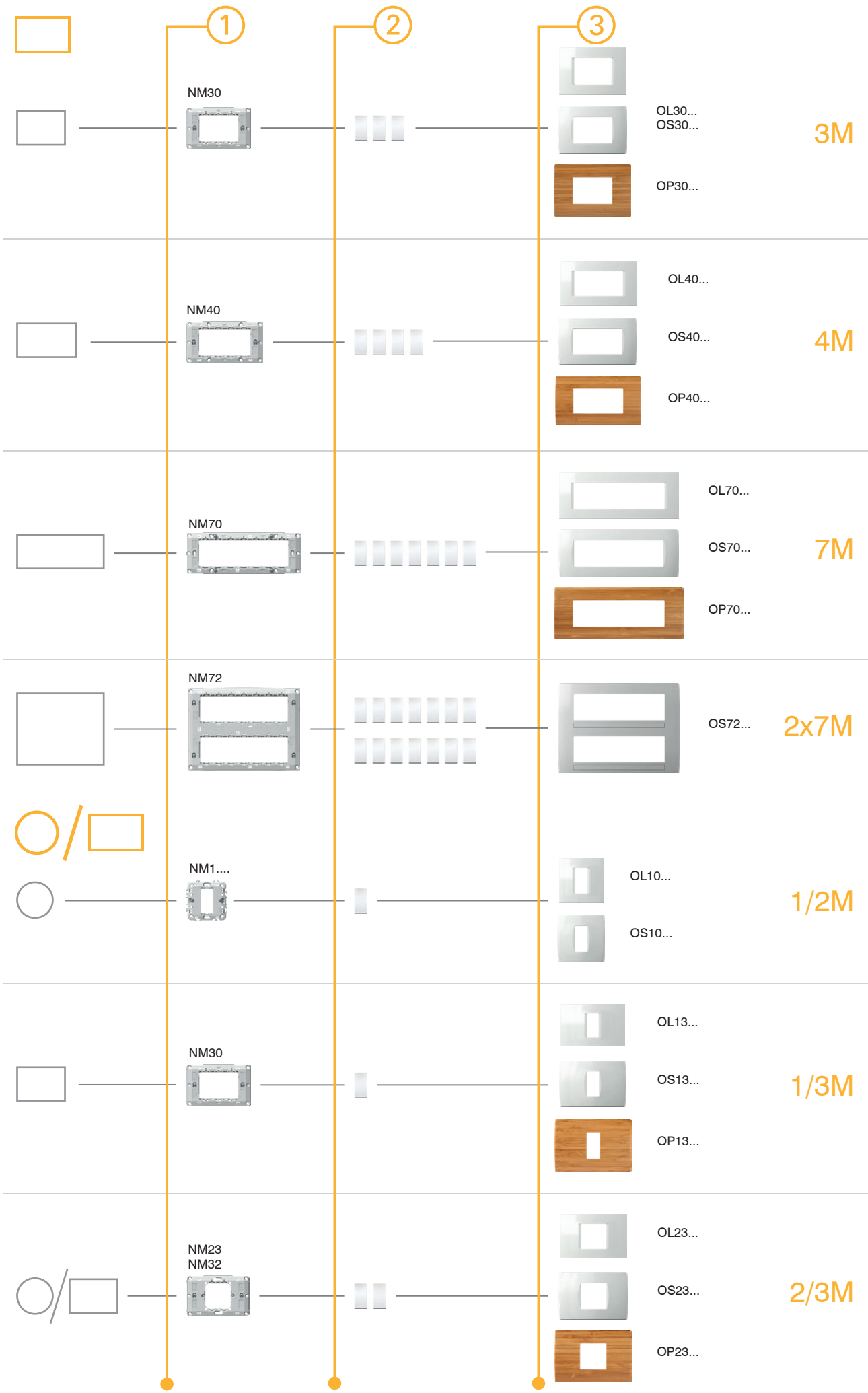

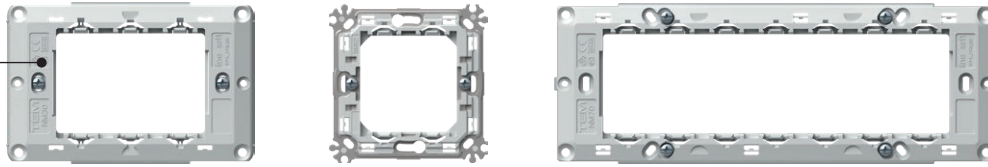

NM30

Iloji type	përshkrimi description	madhësia size
NM10	KORNIZË MONTIMI ME KTHETRA MOUNTING FRAME WITH CLAWS	1/2M
NM11	KORNIZË MONTIMI PA VIDA MOUNTING FRAME WITHOUT SCREWS	1/2M
NM20	KORNIZË MONTIMI ME KTHETRA MOUNTING FRAME WITH CLAWS	2M
...



KORNIZË MONTIMI ME KTHETRA 2M

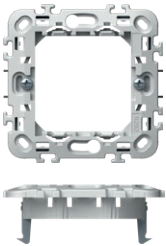

NM20

- kornizë montimi 2M me kthetra
- për montimin në kutitë Ø60 (DE..) me kthetra
- kombinime të mundshme horizontale ose vertikale 2x2M, 3x2M dhe 4x2M
- i përshatshëm për montimin me kapakët mbulues LINE dhe SOFT
- në përputhje me EN 60669-1

MOUNTING FRAME WITH CLAWS 2M

- mounting frame 2M with claws
- for mounting on boxes Ø60 (DE..) with claws
- possible horizontal or vertical combinations 2x2M, 3x2M and 4x2M
- suitable for assembling with cover plates LINE and SOFT
- in accordance with EN 60669-1

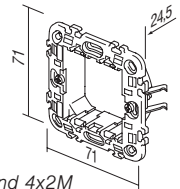

KORNIZË MONTIMI PA VIDA 2M

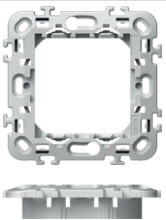

NM21

- kornizë montimi 2M pa vida dhe pa kthetra
- për montimin në kutitë Ø60 (HE..., DE..) me vida
- kombinime të mundshme horizontale ose vertikale 2x2M, 3x2M dhe 4x2M
- i përshatshëm për montimin me kapakët mbulues LINE dhe SOFT
- në përputhje me EN 60669-1

MOUNTING FRAME WITHOUT SCREWS 2M

- mounting frame 2M without screws and without claws
- for mounting on boxes Ø60 (HE..., DE..) with screws
- possible horizontal or vertical combinations 2x2M, 3x2M and 4x2M
- suitable for assembling with cover plates LINE and SOFT
- in accordance with EN 60669-1

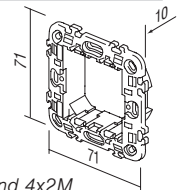

KORNIZË MONTIMI METALIKE ME KTHETRA 2M

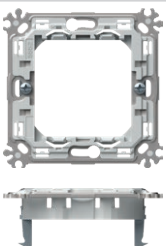

NM24

- kornizë montimi metalike 2M me kthetra - versioni i fortë
- për montimin në kutitë Ø60 (DE..) me kthetra
- kombinime të mundshme horizontale ose vertikale 2x2M, 3x2M dhe 4x2M
- i përshatshëm për montimin me kapakët mbulues PURE, LINE dhe SOFT
- në përputhje me EN 60669-1

MOUNTING FRAME METAL WITH CLAWS 2M

- metal mounting frame 2M with claws - stiff version
- for mounting on boxes Ø60 (DE..) with claws
- possible horizontal or vertical combinations 2x2M, 3x2M and 4x2M
- suitable for assembling with cover plates PURE, LINE and SOFT
- in accordance with EN 60669-1

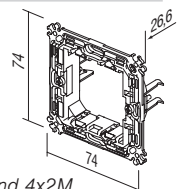

KORNIZË MONTIMI METALIKE PA VIDA 2M

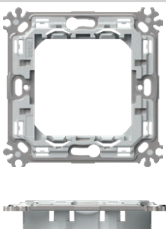

NM25

- kornizë montimi metalike me vida dhe pa kthetra - versioni i fortë
- për montimin në kutitë Ø60 (HE..., DE..) me vida
- kombinime të mundshme horizontale ose vertikale 2x2M, 3x2M dhe 4x2M
- i përshatshëm për montimin me kapakët mbulues PURE, LINE dhe SOFT
- në përputhje me EN 60669-1

MOUNTING FRAME METAL WITHOUT SCREWS 2M

- metal mounting frame 2M without screws and without claws - stiff version
- for mounting in boxes Ø60 (HE..., DE..) with screws
- possible horizontal or vertical combinations 2x2M, 3x2M and 4x2M
- suitable for assembling with cover plates PURE, LINE and SOFT
- in accordance with EN 60669-1

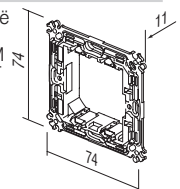

M O U N T I N G F R A M E S N M

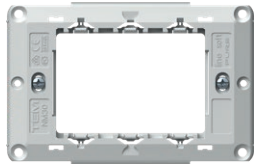

NM30

KORNIZË MONTIMI ME VIDA 3M

- kornizë montimi 3M me vida
 - për montim në kutitë drejtkëndore 3M
 - i përshtatshëm për montimin me kapakët mbulues PURE, LINE dhe SOFT
 - në përputhje me EN 60669-1
- MOUNTING FRAME WITH SCREWS 3M**
- mounting frame 3M with screws
 - for mounting on rectangular boxes 3M
 - suitable for assembling with cover plates PURE, LINE and SOFT
 - in accordance with EN 60669-1

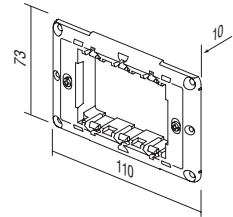

NM40

KORNIZË MONTIMI ME VIDA 4M

- kornizë montimi 4M me vida
 - për montim në kutitë drejtkëndore 4M
 - i përshtatshëm për montimin me kapakët mbulues PURE, LINE dhe SOFT
 - në përputhje me EN 60669-1
- MOUNTING FRAME WITH SCREWS 4M**
- mounting frame 4M with screws
 - for mounting on rectangular boxes 4M
 - suitable for assembling with cover plates PURE, LINE and SOFT
 - in accordance with EN 60669-1

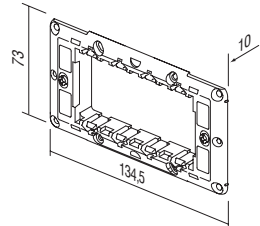

NM70

KORNIZË MONTIMI ME VIDA 7M

- kornizë montimi 7M me vida
- për montim në kutitë drejtkëndore 7M
- i përshtatshëm për montimin me kapakët mbulues PURE LINE DHE SOFT
- në përputhje me EN 60669-1

MOUNTING FRAME WITH SCREWS 7M

- mounting frame 7M with screws
- for mounting on rectangular boxes 7M
- suitable for assembling with cover plates PURE, LINE and SOFT
- in accordance with EN 60669-1

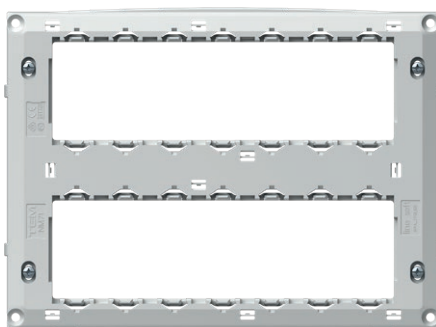
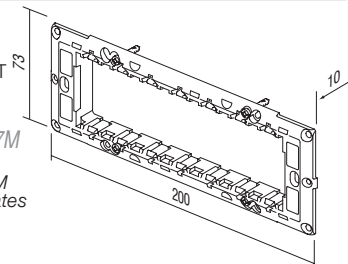

NM72

KORNIZË MONTIMI ME VIDA 2x7M

- kornizë montimi me vida 2x7M
- për montim në kutitë drejtkëndore 2x7M
- i përshtatshëm për montimin me kapak mbulues SOFT OS72
- në përputhje me EN 60669-1

MOUNTING FRAME WITH SCREWS 2x7M

- mounting frame 2x7M with screws
- for mounting on rectangular boxes 2x7M
- suitable for assembling with cover plate SOFT OS72
- in accordance with EN 60669-1

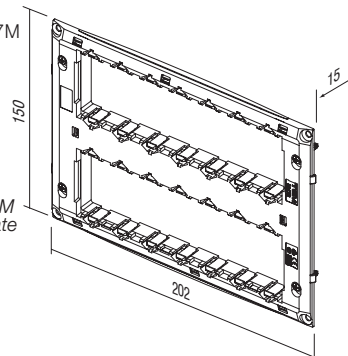

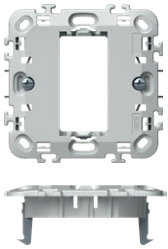

NM10

KORNIZË MONTIMI ME KTHETRA 1/2M

- kornizë montimi 1/2M me kthetra
- për montimin në kutitë Ø60 (DE..) me kthetra
- i përshtatshëm për montimin me kapakët mbulues LINE dhe SOFT
- në përputhje me EN 60669-1

MOUNTING FRAME WITH CLAWS 1/2M

- mounting frame 1/2M with claws
- for mounting on boxes Ø60 (DE..) with claws
- suitable for assembling with cover plates LINE and SOFT
- in accordance with EN 60669-1

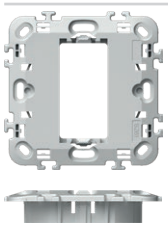
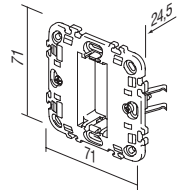

NM11

KORNIZË MONTIMI PA VIDA 1/2M

- kornizë montimi 1/2M pa vida dhe pa kthetra
- për montimin në kutitë Ø60 (HE., DE..) me vida
- i përshtatshëm për montimin me kapakët mbulues LINE dhe SOFT
- në përputhje me EN 60669-1

MOUNTING FRAME WITHOUT SCREWS 1/2M

- mounting frame 1/2M without screws and without claws
- for mounting on boxes Ø60 (HE., DE..) with screws
- suitable for assembling with cover plates LINE and SOFT
- in accordance with EN 60669-1

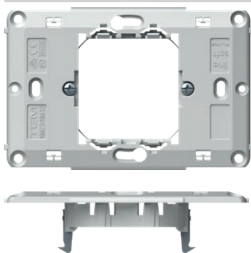
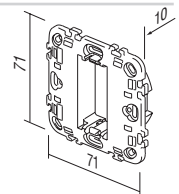

NM23

KORNIZË MONTIMI ME KTHETRA 2/3M

- kornizë montimi 2/3M me kthetra
- për montimin në kutitë Ø60 (DE..) me kthetra
- i përshtatshëm për montimin me kapakët mbulues PURE, LINE dhe SOFT
- në përputhje me EN 60669-1

MOUNTING FRAME WITH CLAWS 2/3M

- mounting frame 2/3M with claws
- for mounting on boxes Ø60 (DE..) with claws
- suitable for assembling with cover plates PURE, LINE and SOFT
- in accordance with EN 60669-1

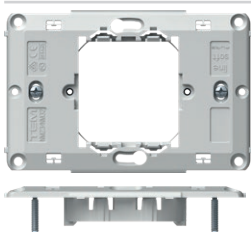
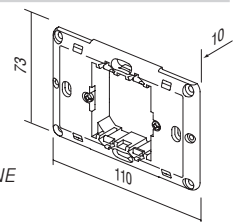

NM32

KORNIZË MONTIMI ME VIDA 2/3M

- kornizë montimi 2/3M me vida
- për montim në kutitë drejtkëndore 3M
- i përshtatshëm për montimin me kapakët mbulues PURE, LINE dhe SOFT
- në përputhje me EN 60669-1

MOUNTING FRAME WITH SCREWS 2/3M

- mounting frame 2/3M with screws
- for mounting on rectangular boxes 3M
- suitable for assembling with cover plates PURE, LINE and SOFT
- in accordance with EN 60669-1

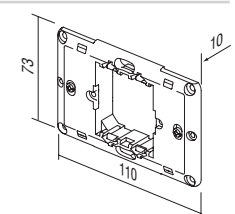

TEM

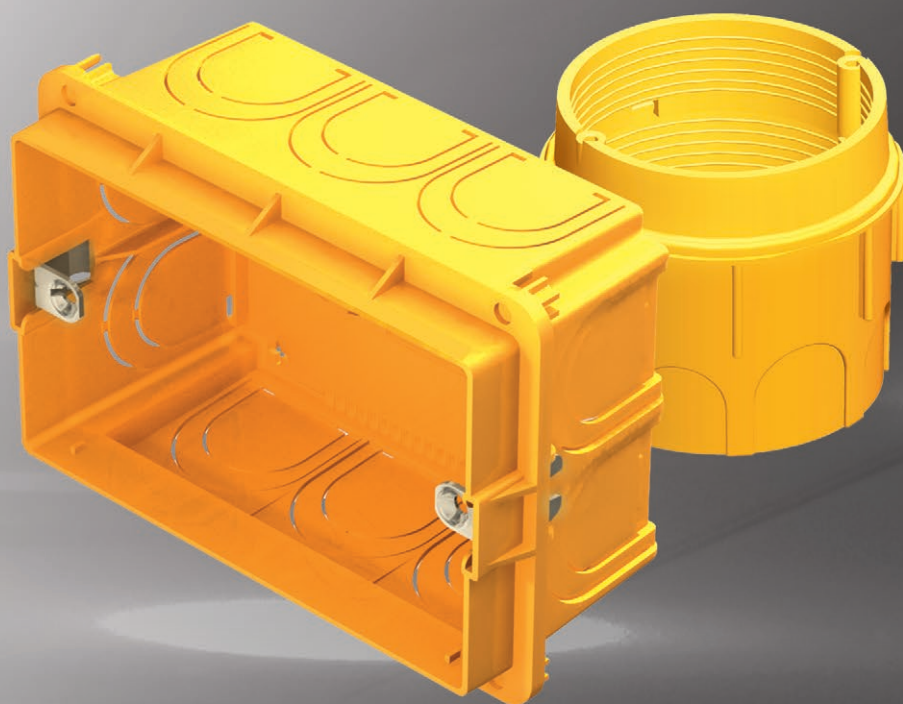

KUTITË



 KUTITË E RRUMBULLAKËTA
 ROUND BOXES

140

 KUTITË DREJTKËNDORE
 RECTANGULAR BOXES



148

 KUTITË LIDHËSE
 JUNCTION BOXES

156

 AKSESORËT E LIDHJEVE
 WIRING ACCESSORIES

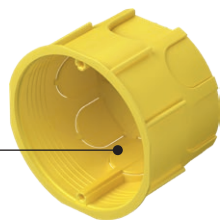
158



DE12



HE11



BE10

lloji type	përshkrimi description	madhësia size
DE10	KUTI E RRUMBULLAKËT TULLË ROUND BOX BRICK	SM60-01
HE10	KUTI E RRUMBULLAKËT MUR BOSH ROUND BOX HOLLOW WALL	SM68X40
BE10	KUTI E RRUMBULLAKËT BETON ROUND BOX CONCRETE	
:	:	:
:	:	:

KUTI E RRUMBULLAKËT TULLË SM60-01



DE10

- Ø60, thellësia 40mm
- 650°C, 500 V \sim
- në përputhje me IEC 60670-1
- pa halogjenë

ROUND BOX BRICK SM60-01

- Ø60, depth 40mm
- 650°C, 500V \sim
- in accordance with IEC 60670-1
- halogen free

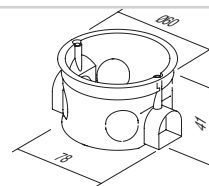

KUTI E RRUMBULLAKËT TULLË E THELLË SM60-06



DE11

- Ø60, thellësia 60mm
- 650°C, 500 V \sim
- në përputhje me IEC 60670-1
- pa halogjenë

ROUND BOX BRICK DEEP SM60-06

- Ø60, depth 60mm
- 650°C, 500V \sim
- in accordance with IEC 60670-1
- halogen free

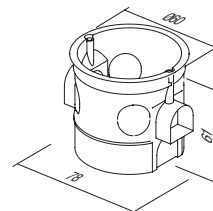

KAPËSE E KOMBINUAR SM60-03



DE30

- për montimin vertikal të kutive SM60-06 ose SM60-01
- në distancë prej 91 mm
- në përputhje me IEC 60670-1
- pa halogjenë

COMBI-CLIP SM60-03

- for vertical fitting of boxes SM60-06 or SM60-01 on distance 91 mm
- in accordance with IEC 60670-1
- halogen free



KAPËSE E KOMBINUAR SM60-04

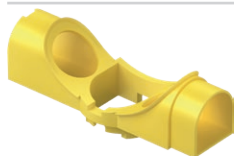

DE31







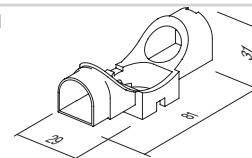



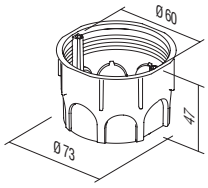

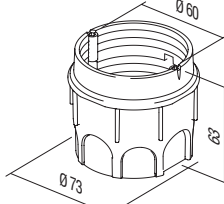

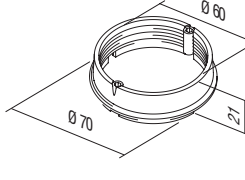
- për montimin horizontal të kutive SM60-06 ose SM60-01
- në distancë prej 71mm
- në përputhje me IEC 60670-1
- pa halogjenë

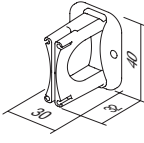
COMBI-CLIP SM60-04

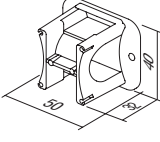
- for horizontal fitting of boxes SM60-06 or SM60-01 on distance 71mm
- in accordance with IEC 60670-1
- halogen free

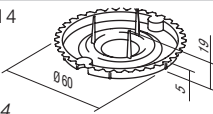

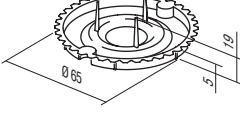
R O U N D B O X E S

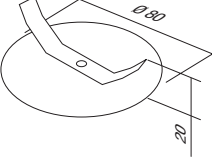
	DE12	<p>KUTI E RRUMBULLAKËT TULLË MD65-46</p> <ul style="list-style-type: none"> - Ø65, thellësia 46 mm - 650°C, 500 V~ - në përputhje me IEC 60670-1 - pa halogjenë <p><i>ROUND BOX BRICK MD65-46</i></p> <ul style="list-style-type: none"> - Ø65, depth 46mm - 650°C, 500V~ - in accordance with IEC 60670-1 - halogen free 	
	DE13	<p>KUTI E RRUMBULLAKËT TULLË E THELLË MD65-60</p> <ul style="list-style-type: none"> - Ø65/60, thellësia 62 mm - 650°C, 500 V~ - në përputhje me IEC 60670-1 - pa halogjenë <p><i>ROUND BOX BRICK DEEP MD65-60</i></p> <ul style="list-style-type: none"> - Ø65/60, depth 62mm - 650°C, 500V~ - in accordance with IEC 60670-1 - halogen free 	
	DE14	<p>PJESË SHITESË PËR MD65-46</p> <ul style="list-style-type: none"> - Ø65/60, thellësia 17mm - 650°C, 500 V~ - në përputhje me IEC 60670-1 - pa halogjenë <p><i>ADDITIONAL PIECE FOR MD65-46</i></p> <ul style="list-style-type: none"> - Ø65/60, depth 17mm - 650°C, 500V~ - in accordance with IEC 60670-1 - halogen free 	
	DE32	<p>KAPËSE E KOMBINUAR MD65-71</p> <ul style="list-style-type: none"> - për montimin e kutive MD65 në distancë prej 71 mm - në përputhje me IEC 60670-1 - pa halogjenë <p><i>COMBI-CLIP MD65-71</i></p> <ul style="list-style-type: none"> - for fitting of boxes MD65 on distance 71mm - in accordance with IEC 60670-1 - halogen free 	
	DE33	<p>KAPËSE E KOMBINUAR MD65-91</p> <ul style="list-style-type: none"> - për montimin e kutive MD65 në distancë prej 91mm - në përputhje me IEC 60670-1 - pa halogjenë <p><i>COMBI-CLIP MD65-91</i></p> <ul style="list-style-type: none"> - for fitting of boxes MD65 on distance 91mm - in accordance with IEC 60670-1 - halogen free 	
	DE20	<p>KAPAK MBROJTËS PËR KUTI 60</p> <ul style="list-style-type: none"> - kapak mbrojtës për kuti Ø60 për DE10, DE11, DE13, DE14 - në përputhje me IEC 60670-1 - mbrojtje për kuti gjatë suvatimit <p><i>BOX COVER PROTECTIVE 60</i></p> <ul style="list-style-type: none"> - protective cover for box Ø60 for DE10, DE11, DE13, DE14 - in accordance with IEC 60670-1 - box protection during plastering 	
	DE21	<p>KAPAK MBROJTËS PËR KUTI 65</p> <ul style="list-style-type: none"> - kapak mbrojtës për kuti Ø65 për DE12 - në përputhje me IEC 60670-1 - mbrojtje për kuti gjatë suvatimit <p><i>BOX COVER PROTECTIVE 65</i></p> <ul style="list-style-type: none"> - protective cover for box Ø65 for DE12 - in accordance with IEC 60670-1 - box protection during plastering 	
	DE22	<p>KAPAK DEKORATIV PËR KUTI SM60</p> <ul style="list-style-type: none"> - kapak dekorativ për kuti Ø60 - në përputhje me IEC 60670-1 - pa halogjenë <p><i>BOX COVER DECORATIVE SM60</i></p> <ul style="list-style-type: none"> - decorative cover for boxes Ø60 - in accordance with IEC 60670-1 - halogen free 	



K U T I T Ë

udhëzime për montimin /
assembly instructions

distanca mes kutive /
distance between boxes: 71 mm

distanca mes kutive /
distance between boxes: 91 mm

DE10,11

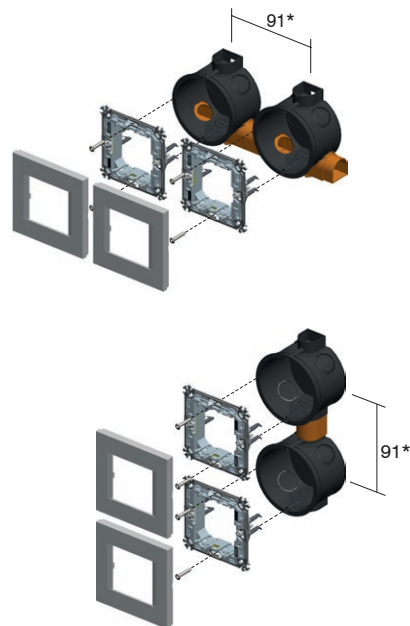
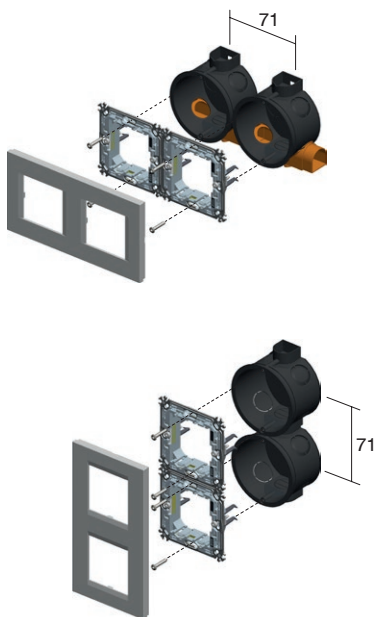
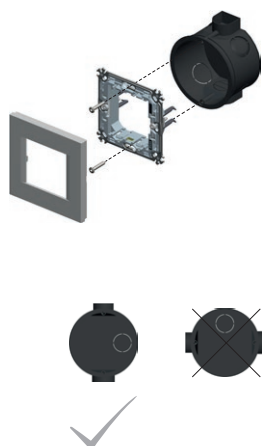

DE12,13

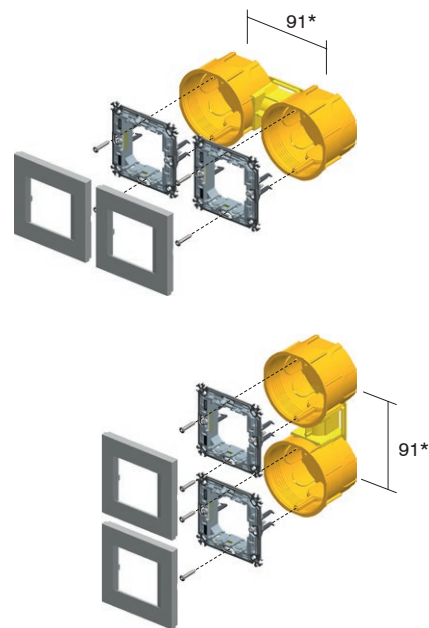
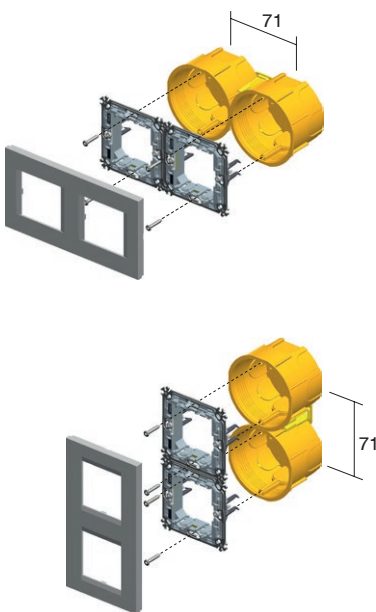
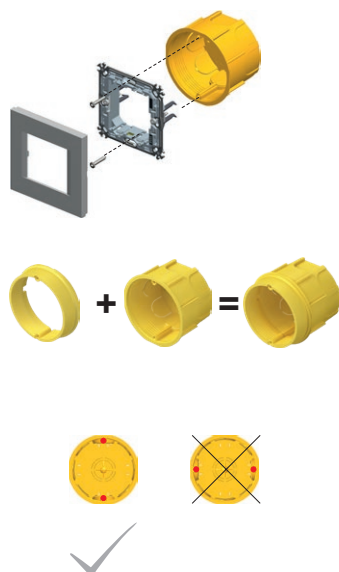

* për kapakët mbulues PURE distanca minimale mes kutive është 100 mm
* for PURE cover plates the minimum distance between boxes is 100mm

R O U N D B O X E S



DE10,11



DE12,13



NM20



NM24



DE10,11



DE12,13



NM10



DE10,11



DE12,13



NM23



71

2xDE10,11 + 2xDE31



2xNM20



2xDE12,13 + 1xDE32



2xNM24



2xDE10,11 2xDE12,13 + 1xDE32

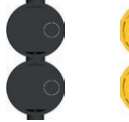

2xNM20



2xNM24



3xDE10,11 + 3xDE31



3xNM20



3xDE12,13 + 2xDE32



3xNM24



3xDE10,11 3xDE12,13 + 2xDE32

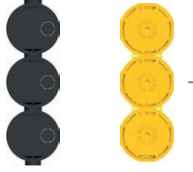

3xNM20



3xNM24



4xDE10,11 + 4xDE31



4xNM20



4xDE12,13 + 3xDE32



4xNM24



4xDE10,11 4xDE12,13 + 3xDE32

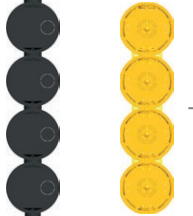

4xNM20



4xNM24

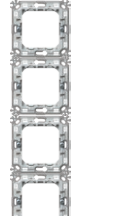



HE10

KUTI E RRUMBULLAKËT MUR BOSH SM68x40

- Ø60, thellësia 40 mm
- vrima e prerjes Ø68
- 850°C, 400V~
- në përputhje me IEC 60670-1
- montim me kthetra
- pa halogjenë

ROUND BOX HOLLOW WALL SM68x40

- Ø60, depth 40mm
- cutting hole Ø68
- 850°C, 400V~
- in accordance with IEC 60670-1
- mounting with claws
- halogen free

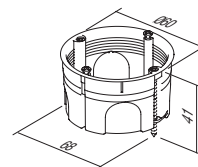

HE11

KUTI E RRUMBULLAKËT MUR BOSH SM68x55

- Ø60, thellësia 55mm
- vrima e prerjes Ø68
- 850°C, 400V~
- në përputhje me IEC 60670-1
- montim me kthetra
- pa halogjenë

ROUND BOX HOLLOW WALL SM68x55

- Ø60, depth 55mm
- cutting hole Ø68
- 850°C, 400V~
- in accordance with IEC 60670-1
- mounting with claws
- halogen free

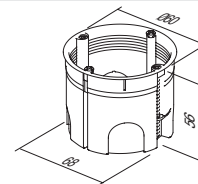

BE10

KUTI E RRUMBULLAKËT BETON

- Ø60, thellësia 49mm
- 650°C, 500 V~
- në përputhje me IEC 60670-1
- pa halogjenë

ROUND BOX CONCRETE

- Ø60mm, depth 49mm
- 650°C, 500V~
- in accordance with IEC 60670-1
- halogen free

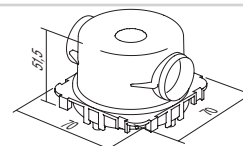

BE11

KUTI E RRUMBULLAKËT BETON E THELLË

- Ø60, thellësia 58mm
- 650°C, 500 V~
- në përputhje me IEC 60670-1
- pa halogjenë

ROUND BOX CONCRETE DEEP

- Ø60mm, depth 58mm
- 650°C, 500V~
- in accordance with IEC 60670-1
- halogen free

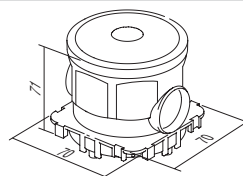

BE20

KUNDËR-SUPORT KUTIE PËR BETON

- për suportin e kutive për beton me profil në distancë BM82 muri përballë
- në përputhje me IEC 60670-1
- pa halogjenë

COUNTER BOX SUPPORT CONCRETE

- to support concrete boxes with discance profile BM82 for extreme loads
- in accordance with IEC 60670-1
- halogen free

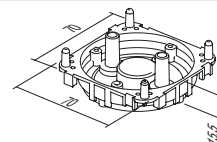

BE21

KUTI PËR BETON PËR BLOKUES TUBI 16

- për mbajtjen e tubit të instalimit në kuti
- në përputhje me IEC 60670-1
- pa halogjenë

PIPE STOPPER CONCRETE BOX 16

- for firming installation pipe to box
- in accordance with IEC 60670-1
- halogen free

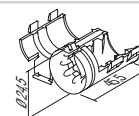

R O U N D B O X E S

mure bosh / hollow walls



beton / concrete

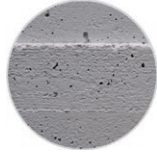

udhëzime për montimin /
assembly instructions

distanca mes kutive /
distance between boxes: 71mm

distanca mes kutive /
distance between boxes: 91mm

HE10,11

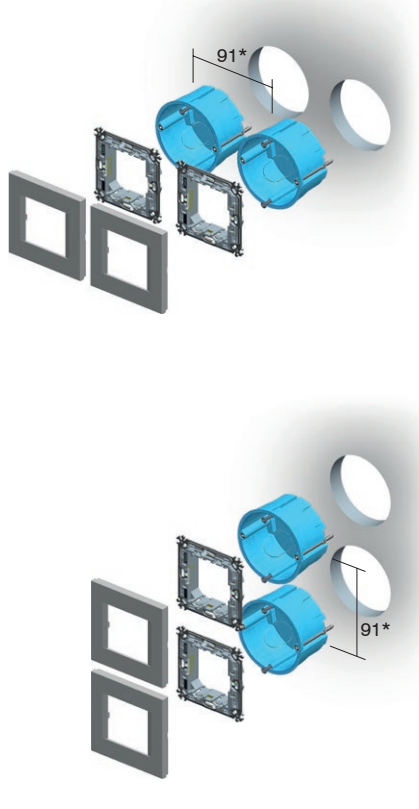
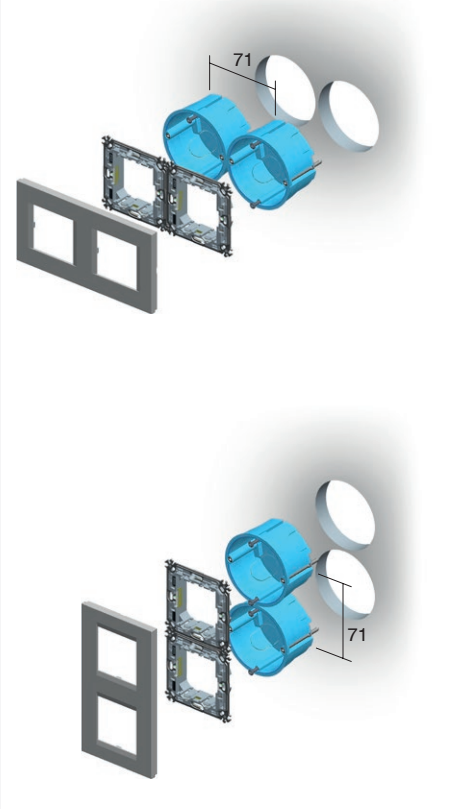
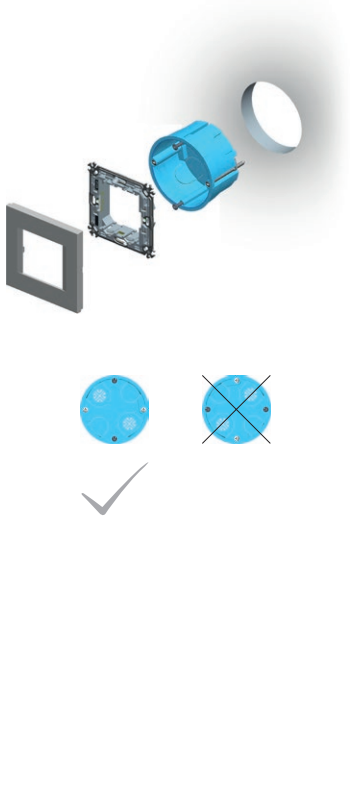

BE10

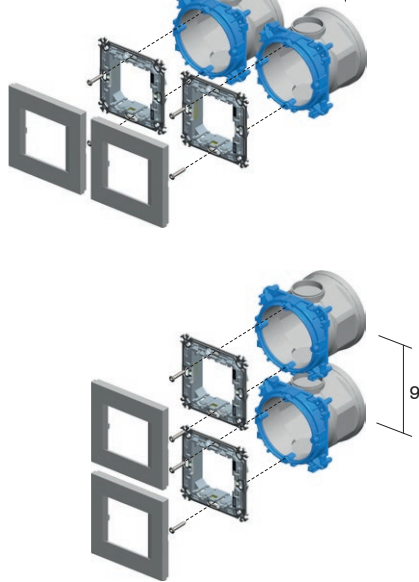
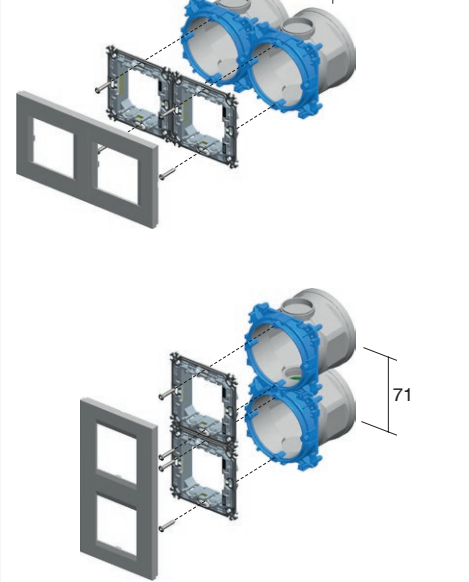
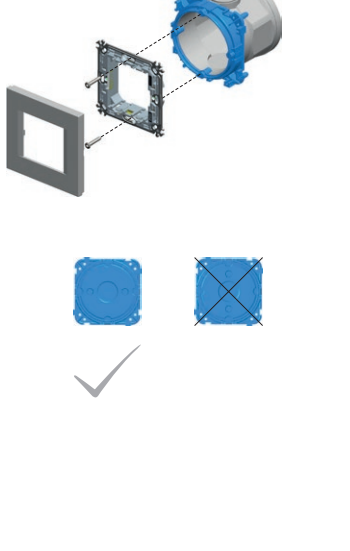

* për kapakët mbulues PURE distanca minimale mes kutive është 100 mm
* for PURE cover plates the minimum distance between boxes is 100mm

K U T I T

K U T I T Ě E R R U M B U L L A K Ě T A

mure bosh / hollow walls



beton / concrete



HE10,11



BE10,11



NM21



NM25



2M

HE10,11



BE10,11



NM11



1/2M

2xHE10,11



2xBE10,11



2xNM21



2xNM25



2x2M

HE10,11



BE10,11



NM32



2/3M

2xHE10,11



2xBE10,11



2xNM21



2xNM25



3xHE10,11



3xBE10,11



3xNM21



3xNM25



3x2M

3xHE10,11



3xBE10,11



3xNM21



3xNM25

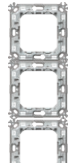

4xHE10,11



4xBE10,11



4xNM21



4xNM25



4x2M

4xHE10,11



4xBE10,11



4xNM21



4xNM25



R O U N D B O X E S

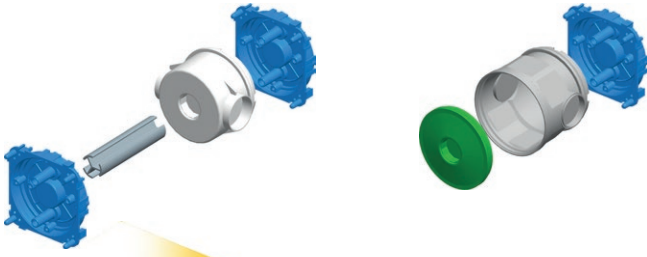

udhëzime për montimin /
assembly instructions

1

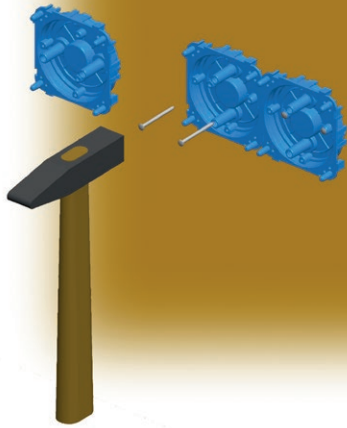

3

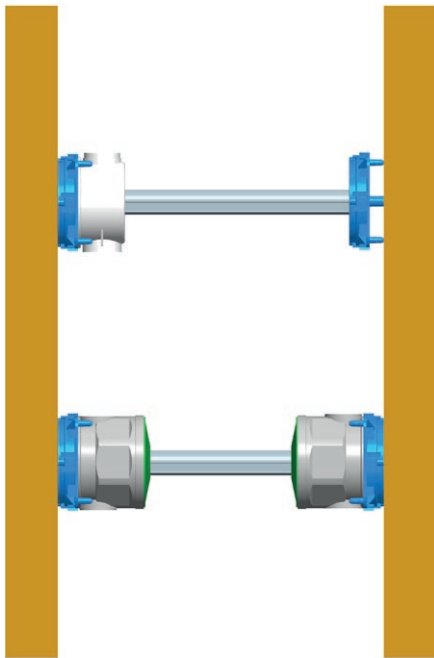

2

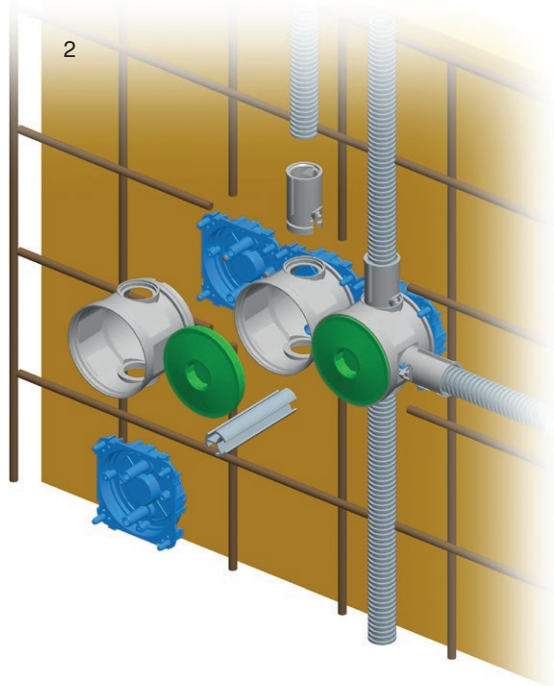

4

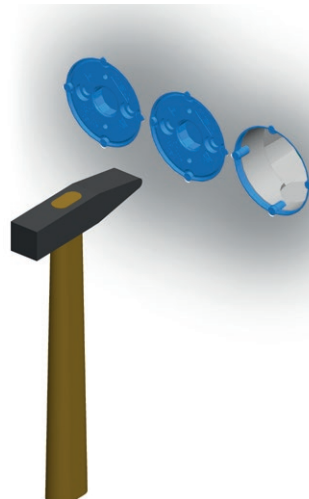

DM30

HM30

BM30

Iloji type	përshkrimi description	madhësia size
DM30	KUTI DREJTKËNDORE TULLË RECTANGULAR BOX BRICK	PM3
HM30	KUTI DREJTKËNDORE MUR BOSH RECTANGULAR BOX HOLLOW WALL	VM3
BM30	KUTI DREJTKËNDORE BETON RECTANGULAR BOX CONCRETE	BM3
·	·	·
·	·	·

KUTI DREJTKËNDORE TULLË PM3



DM30

- madhësia 3M, thellësia 49 mm
- 650°C, 400V[~]
- në përputhje me IEC 60670-1
- pa halogjenë

RECTANGULAR BOX BRICK PM3

- size 3M, depth 49mm
- 650°C, 400V[~]
- in accordance with IEC 60670-1
- halogen free

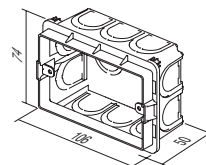

KUTI DREJTKËNDORE TULLË PM3-65



DM31

- madhësia 3M, thellësia 65mm
- 650°C, 400V[~]
- në përputhje me IEC 60670-1
- pa halogjenë

RECTANGULAR BOX BRICK PM3-65

- size 3M, depth 65mm
- 650°C, 400V[~]
- in accordance with IEC 60670-1
- halogen free

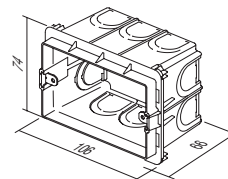

KUTI DREJTKËNDORE TULLË PM4



DM40

- madhësia 4M, thellësia 49 mm
- 650°C, 400V[~]
- në përputhje me IEC 60670-1
- pa halogjenë

RECTANGULAR BOX BRICK PM4

- size 4M, depth 49mm
- 650°C, 400V[~]
- in accordance with IEC 60670-1
- halogen free

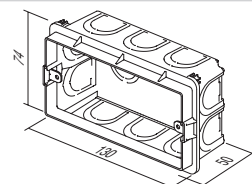

KUTI DREJTKËNDORE TULLË PM4-65



DM41

- madhësia 4M, thellësia 65mm
- 650°C, 400V[~]
- në përputhje me IEC 60670-1
- pa halogjenë

RECTANGULAR BOX BRICK PM4-65

- size 4M, depth 65mm
- 650°C, 400V[~]
- in accordance with IEC 60670-1
- halogen free

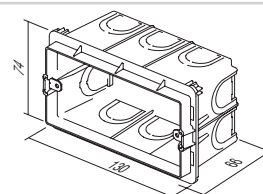

R E C T A N G U L A R B O X E S

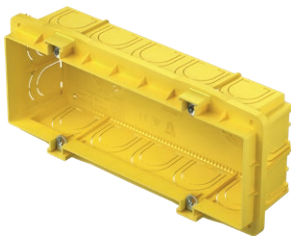

DM70

KUTI DREJTKËNDORE TULLË PM7

- madhësia 7M, thellësia 49 mm
- 650°C, 400V[~]
- në përputhje me IEC 60670-1
- pa halogjenë

RECTANGULAR BOX BRICK PM7

- size 7M, depth 49mm
- 650°C, 400V[~]
- in accordance with IEC 60670-1
- halogen free

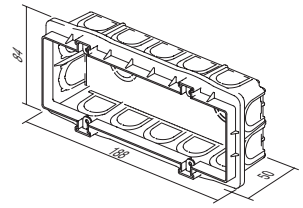

DM71

KUTI DREJTKËNDORE TULLË PM7-65

- madhësia 7M, thellësia 65mm
- 650°C, 400V[~]
- në përputhje me IEC 60670-1
- pa halogjenë

RECTANGULAR BOX BRICK PM7-65

- size 7M, depth 65mm
- 650°C, 400V[~]
- in accordance with IEC 60670-1
- halogen free

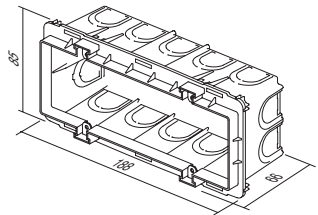

DM72

KUTI DREJTKËNDORE TULLË PM72-65

- madhësia 2x7M, thellësia 64mm
- 650°C, 400V[~]
- në përputhje me IEC 60670-1
- pa halogjenë

RECTANGULAR BOX BRICK PM72-65

- size 2x7M, depth 64mm
- 650°C, 400V[~]
- in accordance with IEC 60670-1
- halogen free

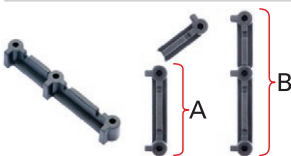
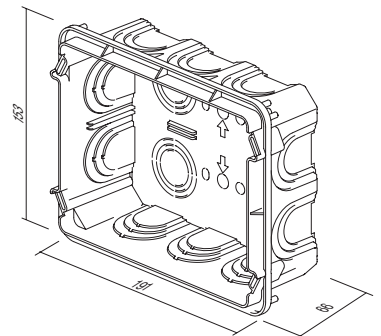

DM80

PJESË DISTANCUESE PËR KUTI PM

- për montim vertikal (A) dhe horizontal (B)
- të kutive PM3, PM4 në PM7
- i përshtatshëm për kapakë mbulues dekorativë Line dhe Soft (jo për PURE)

DISTANCE PIECE FOR BOX PM

- for vertical (A) and horizontal (B) fitting of boxes PM3, PM4 and PM7
- suitable for Line and Soft decorative cover plates (not for PURE)

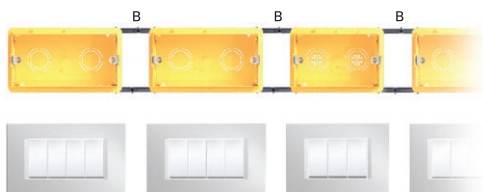
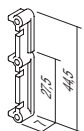



DM33

KAPAK MBROJTËS PËR KUTI PM3

- kapak mbrojtës për kuti PM3
- në përputhje me IEC 60670-1
- pa halogjenë
- mbrojtje për kuti gjatë suvatimit

BOX COVER PROTECTIVE PM3

- protective cover for box PM3
- in accordance with IEC 60670-1
- halogen free
- box protection during plastering

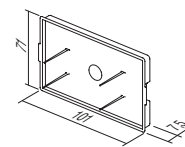

DM34

KAPAK DEKORATIV PËR KUTI PM3

- kapak dekorativ për kuti 3M
- vidat janë të përfshira
- në përputhje me IEC 60670-1
- pa halogjenë

BOX COVER DECORATIVE PM3

- decorative cover for boxes 3M
- screws are included
- in accordance with IEC 60670-1
- halogen free

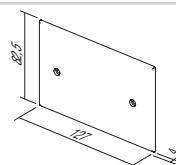

DM43

KAPAK MBROJTËS PËR KUTI PM4

- kapak mbrojtës për kuti PM4
- në përputhje me IEC 60670-1
- pa halogjenë
- mbrojtje për kuti gjatë suvatimit

BOX COVER PROTECTIVE PM4

- protective cover for box PM4
- in accordance with IEC 60670-1
- halogen free
- box protection during plastering

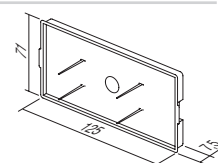

DM44

KAPAK DEKORATIV PËR KUTI PM4

- kapak dekorativ për kuti 4M
- vidat janë të përfshira
- në përputhje me IEC 60670-1
- pa halogjenë

BOX COVER DECORATIVE PM4

- decorative cover for boxes 4M
- screws are included
- in accordance with IEC 60670-1
- halogen free

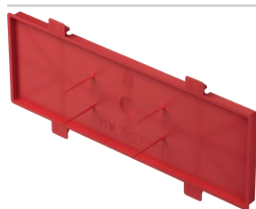
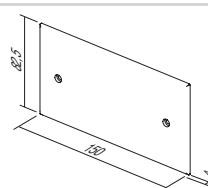

DM73

KAPAK MBROJTËS PËR KUTI PM7

- kapak mbrojtës për kuti PM7
- në përputhje me IEC 60670-1
- pa halogjenë
- mbrojtje për kuti gjatë suvatimit

BOX COVER PROTECTIVE PM7

- protective cover for box PM7
- in accordance with IEC 60670-1
- halogen free
- box protection during plastering

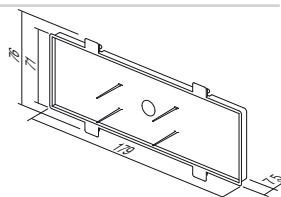

DM74

KAPAK DEKORATIV PËR KUTI PM7

- kapak dekorativ për kuti 7M
- vidat janë të përfshira
- në përputhje me IEC 60670-1
- pa halogjenë

BOX COVER DECORATIVE PM7

- decorative cover for boxes 7M
- screws are included
- in accordance with IEC 60670-1
- halogen free

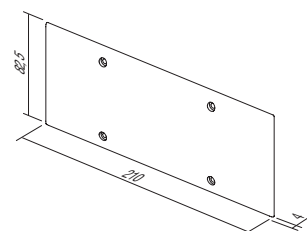

R E C T A N G U L A R B O X E S



DM75

KAPAK DEKORATIV PËR KUTI PM72

- kapak dekorativ për kuti 2x7M
- vidat janë të përfshira
- në përputhje me IEC 60670-1

BOX COVER DECORATIVE PM72

- decorative cover for boxes 2x7M
- screws are included
- in accordance with IEC 60670-1

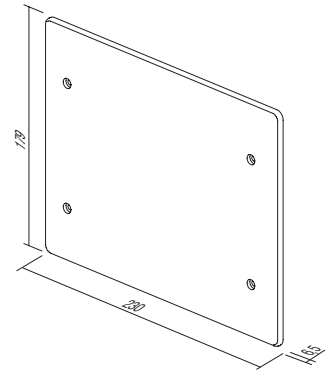



HM30

KUTI DREJTKËNDORE MUR BOSH VM3

- madhësia 3M, thellësia 49 mm
- vrima e prerjes 2xØ68/45mm
- 850°C, 400V[~]
- në përputhje me IEC 60670-1
- pa halogjenë

RECTANGULAR BOX HOLLOW WALL VM3

- size 3M, depth 49mm
- cutting hole 2xØ68/45mm
- 850°C, 400V[~]
- in accordance with IEC 60670-1
- halogen free

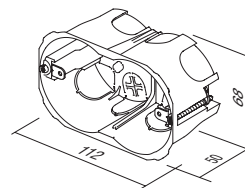

HM40

KUTI DREJTKËNDORE MUR BOSH VM4

- madhësia 4M, thellësia 49 mm
- vrima e prerjes 2xØ68/70mm
- 850°C, 400V[~]
- në përputhje me IEC 60670-1
- pa halogjenë

RECTANGULAR BOX HOLLOW WALL VM4

- size 4M, depth 49mm
- cutting hole 2xØ68/70mm
- 850°C, 400V[~]
- in accordance with IEC 60670-1
- halogen free

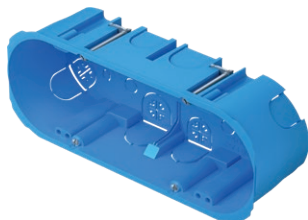
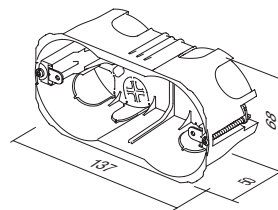

HM70

KUTI DREJTKËNDORE MUR BOSH VM7

- madhësia 7M, thellësia 49 mm
- vrima e prerjes 2xØ68/120mm
- 850°C, 400V[~]
- në përputhje me IEC 60670-1
- pa halogjenë

RECTANGULAR BOX HOLLOW WALL VM7

- size 7M, depth 49mm
- cutting hole 2xØ68/120mm
- 850°C, 400V[~]
- in accordance with IEC 60670-1
- halogen free

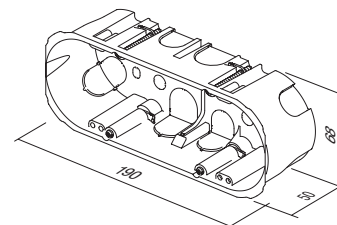

HM72

KUTI DREJTKËNDORE MUR BOSH VM72







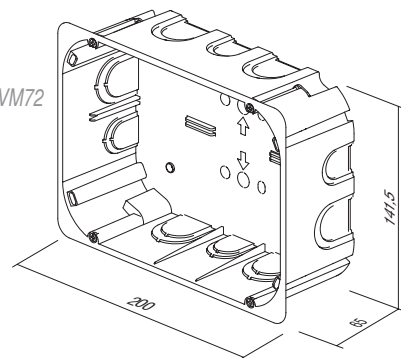

- madhësia 2x7M, thellësia 63mm
- 850°C, 400V[~]
- në përputhje me IEC 60670-1
- pa halogjenë

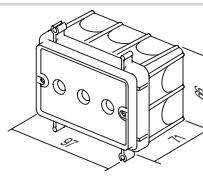
RECTANGULAR BOX HOLLOW WALL VM72

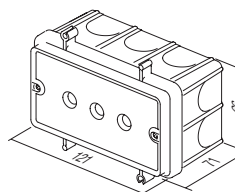
- size 2x7M, depth 63mm
- 850°C, 400V[~]
- in accordance with IEC 60670-1
- halogen free

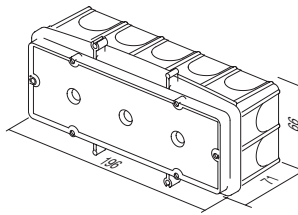

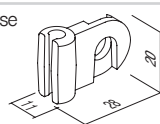
R E C T A N G U L A R B O X E S

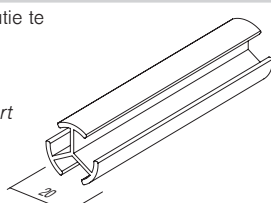
	BM30	KUTI DREJTKËNDORE BETON BM3 - madhësia 3M, thellësia 60mm - 650°C, 400V~ - në përputhje me IEC 60670-1 - pa halogjenë <i>RECTANGULAR BOX CONCRETE BM3</i> - size 3M, depth 60mm - 650°C, 400V~ - in accordance with IEC 60670-1 - halogen free	
	BM40	KUTI DREJTKËNDORE BETON BM4 - madhësia 4M, thellësia 60mm - 650°C, 400V~ - në përputhje me IEC 60670-1 - pa halogjenë <i>RECTANGULAR BOX CONCRETE BM4</i> - size 4M, depth 60mm - 650°C, 400V~ - in accordance with IEC 60670-1 - halogen free	
	BM70	KUTI DREJTKËNDORE BETON BM7 - madhësia 7M, thellësia 60mm - 650°C, 400V~ - në përputhje me IEC 60670-1 - pa halogjenë <i>RECTANGULAR BOX CONCRETE BM7</i> - size 7M, depth 60mm - 650°C, 400V~ - in accordance with IEC 60670-1 - halogen free	
	BM80	KAPËSE FIKSUESE E KOMBINUAR BM - për fiksimin e shpejtë të kutive drejtkëndore BM në shufra përforcuese - i përshtatshëm për diametër shufre deri në Ø8mm <i>FIXING COMBI-CLIP BM</i> - for fast fixation of BM rectangular boxes on reinforcing bar - suitable for bar diameter up to Ø8mm	
	BM82	PROFIL DISTANCUES PËR KUTITË PM - për suportin e kutive BM me kundër-suport kutie te muri përballë - gjatësia l=1m, diametri Ø20mm <i>DISTANCE PROFIL FOR BOXES BM</i> - to support boxes BM with counter box support on opposite wall - length l=1m, diameter Ø20mm	

K U T I T Ë D R E J T K Ë N D O R E



tullë / brick

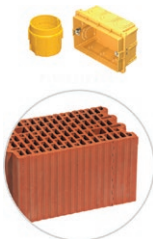

mure bosh / hollow walls

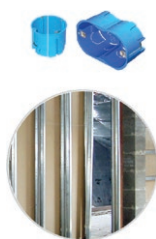

beton / concrete

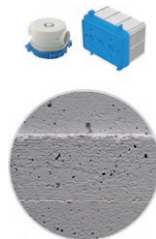

K U T I T Ë

DM30		NM30	3M
HM30			
BM30			
DM40		NM40	4M
HM40			
BM40			
DM70		NM70	7M
HM70			
BM70			
DM72		NM72	2x7M
HM72			
DM30		NM32	2/3M
HM30			
BM30			

R E C T A N G U L A R B O X E S

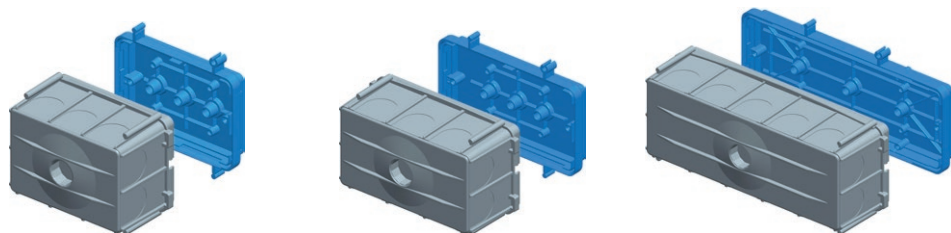

udhëzime për montimin /
assembly instructions

1

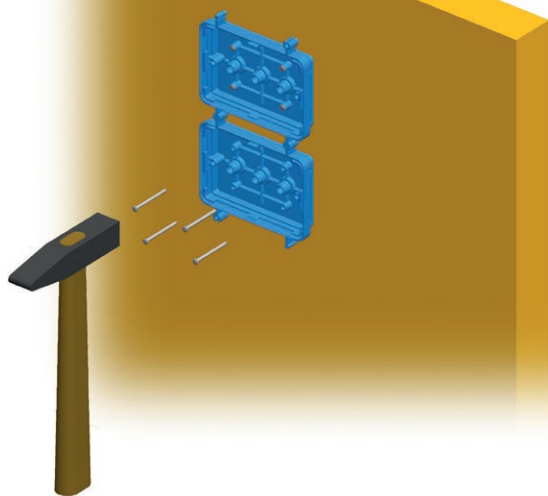

2

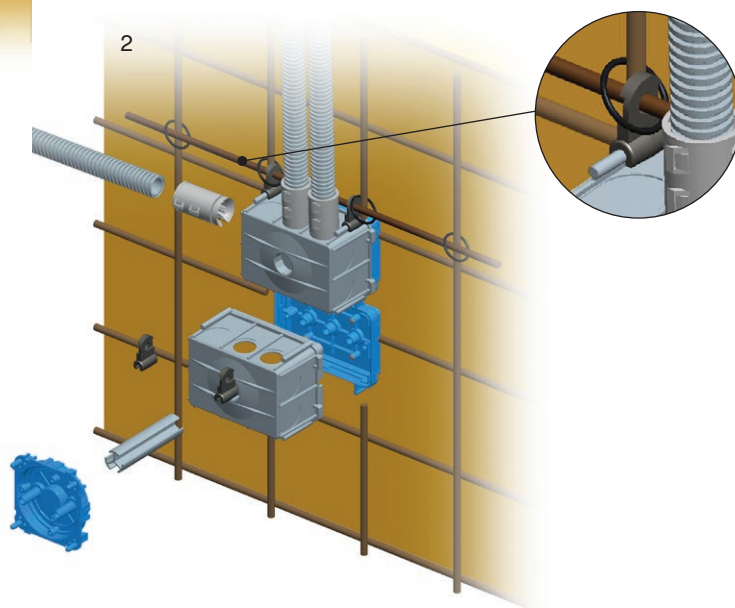

3

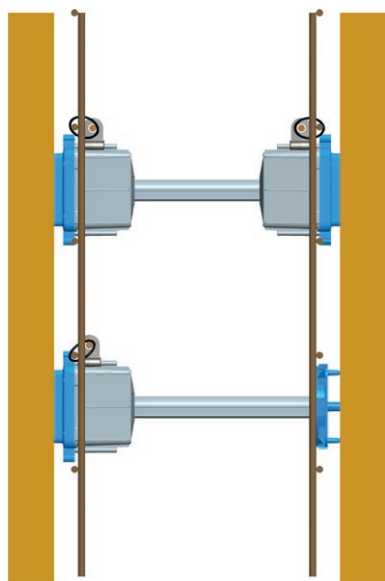

4

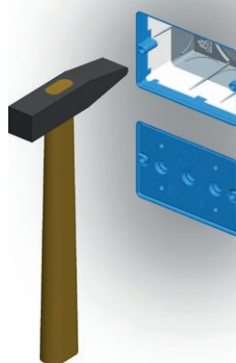



DW10

KUTI E RRUMBULLAKËT TULLË PËR LIDHJE DSM78

- Ø78, thellësia 40 mm
- 650°C, 500 V[~]
- në përputhje me IEC 60670-1 dhe IEC 60670-22
- pa halogjenë

CONNECTION ROUND BOX BRICK DSM78

- Ø78, depth 40mm
- 650°C, 500V[~]
- in accordance with IEC 60670-1 and IEC 60670-22
- halogen free

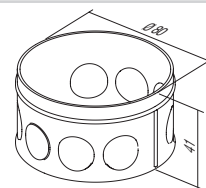

HW10

KUTI E RRUMBULLAKËT MUR BOSH SM78x45

- Ø78, thellësia 45mm
- vrima e prerjes Ø80
- 850°C, 400V[~]
- në përputhje me IEC 60670-1 dhe IEC 60670-22
- montim me kthetra
- pa halogjenë

CONNECTION ROUND BOX HOLLOW WALL SM78x45

- Ø78, depth 45mm
- cutting hole Ø80
- 850°C, 400V[~]
- in accordance with IEC 60670-1 and IEC 60670-22
- mounting with claws
- halogen free

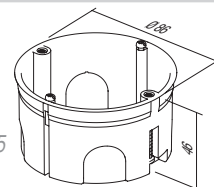

DE23

KAPAK DEKORATIV PËR KUTI SM78

- kapak dekorativ për kuti Ø78
- në përputhje me IEC 60670-1 dhe IEC 60670-22
- pa halogjenë

BOX COVER DECORATIVE SM78

- decorative cover for boxes Ø78
- in accordance with IEC 60670-1 and IEC 60670-22
- halogen free

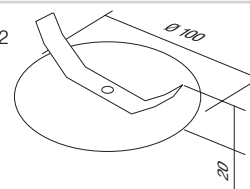

DE24

KAPAK MBROJTËS PËR KUTI 78

- kapak mbrojtës për kuti Ø78
- në përputhje me IEC 60670-1 dhe IEC 60670-22
- pa halogjenë

BOX COVER PROTECTIVE 78

- protective cover for box Ø78
- in accordance with IEC 60670-1 and IEC 60670-22
- halogen free

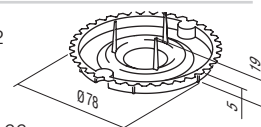

HW20

KUTI KATRORE TULLË PËR LIDHJE SM105x105

- madhësia 105X105 mm, thellësia 50 mm
- vrimë prerjeje sipas shabllonit bashkëngjitur
- 850°C, 400V[~]
- në përputhje me IEC 60670-1 dhe IEC 60670-22
- montim me kthetra
- pa halogjenë

CONNECTION SQUARE BOX BRICK SM105x105

- size 105x105mm, depth 50mm
- cutting hole according to attached template
- 850°C, 400V[~]
- in accordance with IEC 60670-1 and IEC 60670-22
- mounting with claws
- halogen free

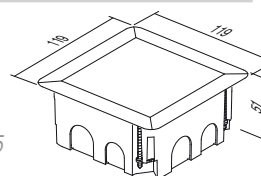

J U N C T I O N B O X E S

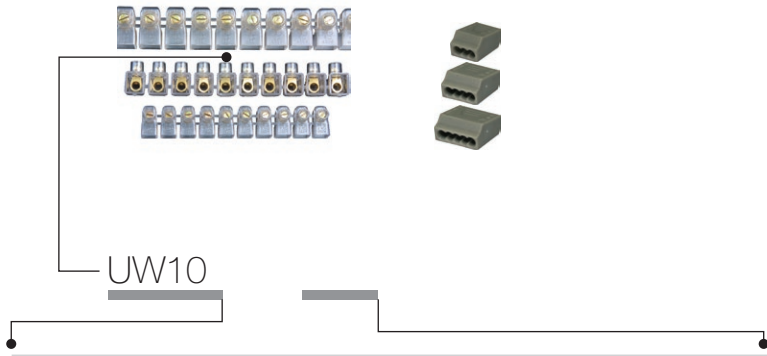

Iloji type	përshkrimi description	të dhënat teknike technical data	madhësia size	ngjyra colour
UW10	BLOQE TERMINALESHE ME 1 RADHË 1 ROW TERMINAL BLOCKS	2x2.5mm ²	10P	<input checked="" type="checkbox"/> TS transparent transparent
UW11	BLOQE TERMINALESHE ME 1 RADHË 1 ROW TERMINAL BLOCKS	2x4mm ²	10P	<input checked="" type="checkbox"/> CO ngjyra colour
UW12	BLOQE TERMINALESHE ME 1 RADHË 1 ROW TERMINAL BLOCKS	2x6mm ²	10P	<input type="checkbox"/> WH e bardhë white
:	:	:	:	<input type="checkbox"/> GY gri grey

BLOQE TERMINALESHE ME 1 RADHË TË MBYLLURA



- 450 V~; 2x2,5 mm² ÷ 2x6mm²
- termoplast PC, transparent
- numri i poleve: 10

1 ROW TERMINAL BLOCKS CLOSED

- 450V~; 2x2.5mm² ÷ 2x6mm²
- thermoplast PC, transparent
- number of poles: 10

UW10TS	(NS12)	2x2.5mm ²	10P
UW11TS	(NS12)	2x4mm ²	10P
UW12TS	(NS12)	2x6mm ²	10P

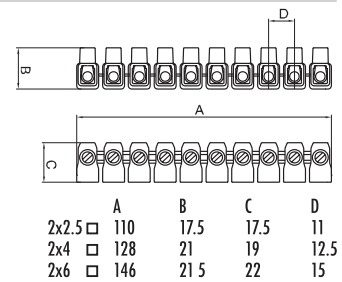

BLOQE TERMINALESHE ME 1 RADHË

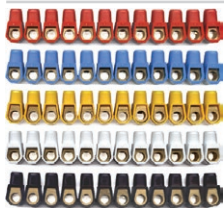

- 450 V~; 2x2,5 mm² ÷ 2x6mm²
- termoplast PA
- e disponueshme në ngjyra të ndryshme
- numri i poleve: 12

1 ROW TERMINAL BLOCKS

- 450V~; 2x2.5mm² ÷ 2x6mm²
- thermoplast PA
- available in different colours
- number of poles: 12

UW15CO	(NS12)	2x2.5mm ²	12P
UW16CO	(NS12)	2x4mm ²	12P
UW17CO	(NS12)	2x6mm ²	12P

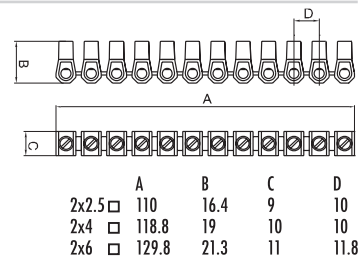

BLOQE TERMINALESHE ME 2 RADHË PP

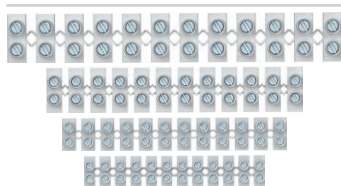

- 450 V~; 1 mm² ÷ 16 mm²
- termoplast polipropilen PP, e bardhë
- për temperaturat deri në 80°C
- numri i poleve: 12

2 ROW TERMINAL BLOCKS PP

- 450V~; 1mm² ÷ 16mm²
- thermoplast polypropylene PP, white
- for temperatures up to 80°C
- number of poles: 12

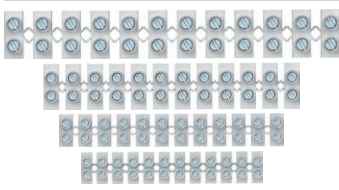

					A	B	C	D	E
UW29WHPP	1.0-4.0mm ²	24 A	450 V		94,9	13	16,6	8,1	6,4
UW30WHPP	1.5-6.0mm ²	32 A	450 V		116,5	14,9	18,9	10	7,3
UW31WHPP	2.5-10mm ²	41 A	450 V		133,8	17,3	23,4	11,5	10
UW32WHPP	4-16mm ²	76 A	450 V		174,5	20,7	25	15	11

**BLOQJE TERMINALESH ME 2 RADHË PA**

- 450 V \sim ; 1 mm² ÷ 16 mm²
- termoplast poliamid PA, e bardhë
- për temperaturat deri në 110°C
- numri i poleve: 12

2 ROW TERMINAL BLOCKS PA

- 450V \sim ; 1mm² ÷ 16mm²
- thermoplast polyamide PA, white
- for temperatures up to 110°C
- number of poles: 12

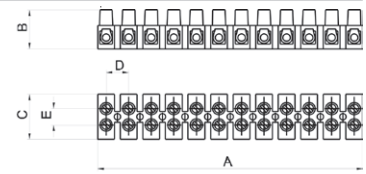

					A	B	C	D	E
UW25WHPA	1.0-4.0mm ²	24 A	450 V		93,6	13,4	16,2	8	6,4
UW26WHPA	1.5-6.0mm ²	32 A	450 V		117	15	18,6	10	7,3
UW27WHPA	2.5-10mm ²	41 A	450 V		132,8	17,3	22,2	11,5	10
UW28WHPA	4-16mm ²	76 A	450 V		173,9	20,8	25,2	15	11

KONEKTORË PËR FUTJE TELASH

- 24 A 450 V \sim , termoplast PA, gri
- numri i poleve: 3÷8
- kontakte për futje telash 0,5÷1,5 mm², për tela të fortë
- në përputhje me EN 60998-1

PLUG-IN WIRE CONNECTORS

- 24A 450V \sim , thermoplast PA, grey
- number of poles: 3÷8
- plug-in contacts 0.5÷1.5mm², for rigide wires
- in accordance with EN 60998-1

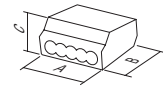

UW40GY	PC153	1.5mm ²	3P	3P	A 12	B 18	C 9
UW41GY	PC155	1.5mm ²	5P	5P	17	18	9
UW42GY	PC158	1.5mm ²	8P	8P	26	18	9

KONEKTORË PËR FUTJE TELASH

- 24 A 450 V \sim , termoplast PA, gri
- numri i poleve: 3÷5
- kontakte për futje telash 1,5÷2,5mm², për tela të fortë
- në përputhje me EN 60998-1

PLUG-IN WIRE CONNECTORS

- 24A 450V \sim , thermoplast PA, grey
- number of poles: 3÷5
- plug-in contacts 1.5÷2.5mm², for rigide wires
- in accordance with EN 60998-1

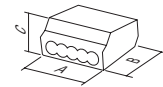

UW45GY	PC253	2.5mm ²	3P	3P	A 14	B 19	C 9
UW46GY	PC254	2.5mm ²	4P	4P	17	19	9
UW47GY	PC255	2.5mm ²	5P	5P	21	19	9

KONEKTOR PËR FUTJE TELASH

- 24 A 450 V \sim , termoplast PA, gri
- numri i poleve: 2 (tel i fortë)+1 (tel i butë)
- kontakte për futje telash 1,5÷2,5mm²
- në përputhje me EN 60998-1

PLUG-IN WIRE CONNECTOR

- 24A 450V \sim , thermoplast PA, grey
- number of poles: 2 (rigide wire)+1 (soft wire)
- plug-in contacts 1.5÷2.5mm²
- in accordance with EN 60998-1

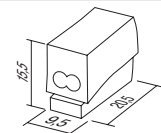

UW50WH	PC302	2.5mm ²	2/1P				
--------	-------	--------------------	------	--	--	--	--

TEM

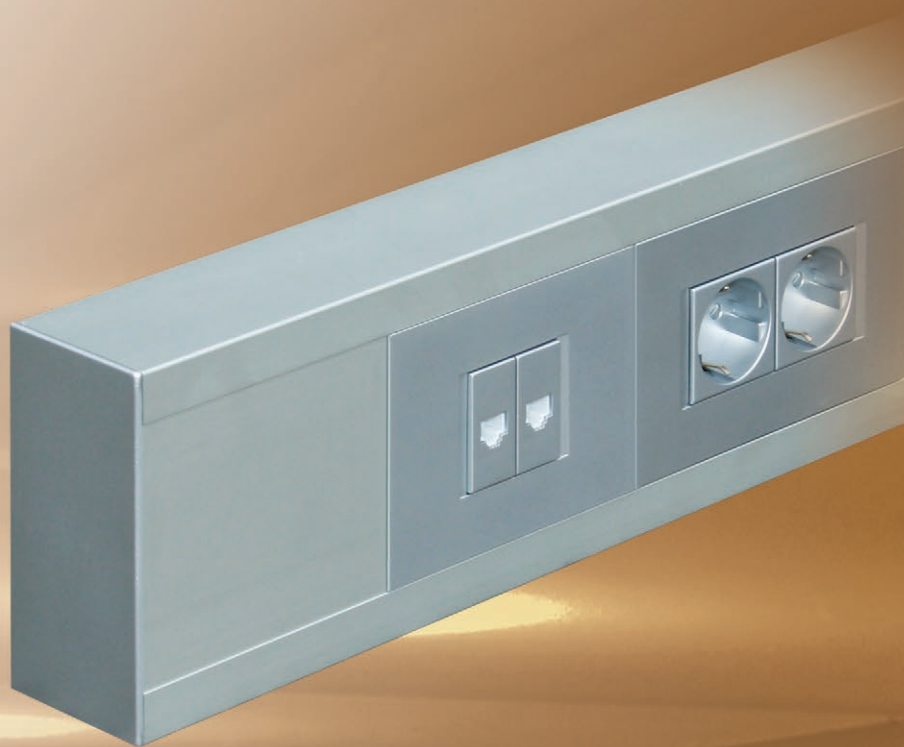

KATALOGU /
CATALOGUE

shpërndarja



KUTI CUBO IP20 AC
BOXES CUBO IP20 AC



162

KUTI CUBO IP55 AQ
BOXES CUBO IP55 AQ



163

SISTEME KANALINASH ALUMINI MA
TRUNKING SYSTEM ALUMINIUM MA



165

KUTI DYSHEMEJE MT
FLOOR BOXES MT



171

QARQE SHPËRNDARJEJE MO
DISTRIBUTION BOARDS MO



173

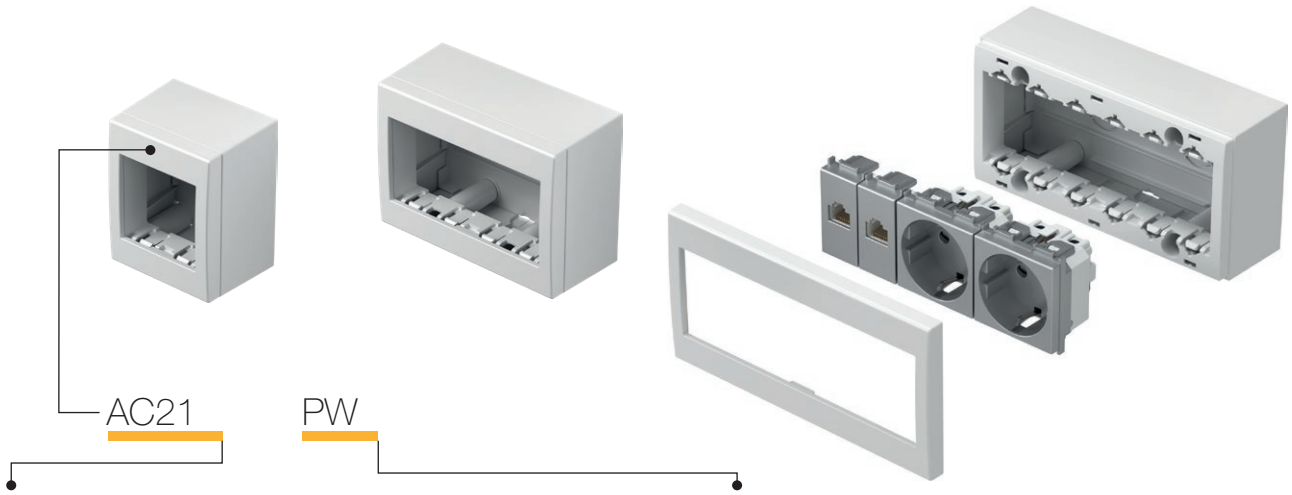

Iloji type	përshkrimi description	të dhënat teknike technical data	madhësia size	ngjyra colour
AC11	KUTI PËR MONTIM NË SIPËRFAQE NO CUBO ME KAPAK TË PASMË ANËSOR SURFACE MOUNT BOX WITH BACK SIDE COVER	IP20	1M	<input type="checkbox"/> PW e bardhë polare polar white <input type="checkbox"/> ES e argjendtë elox elox silver
AC21	KUTI PËR MONTIM NË SIPËRFAQE NO CUBO ME KAPAK TË PASMË ANËSOR SURFACE MOUNT BOX WITH BACK SIDE COVER	IP20	2M	<input type="checkbox"/> IW e bardhë fildishi ivory white
AC41	KUTI PËR MONTIM NË SIPËRFAQE NO CUBO ME KAPAK TË PASMË ANËSOR SURFACE MOUNT BOX WITH BACK SIDE COVER	IP20	4M	

KUTI NO CUBO ME KAPAK TË PASMË ANËSOR IP20 1M



- AC11PW
- AC11ES
- AC11IW

- kuti IP20 1M
 - për montimin në sipërfaqe të elementeve
 - e përshtatshme për celësat SM
 - në përputhje me EN 60669-1

BOX NO CUBO WITH BACK SIDE COVER IP20 1M
 - box IP20 1M
 - for surface mounting of elements
 - suitable to SM switches
 - in accordance with EN 60669-1



KUTI NO CUBO ME KAPAK TË PASMË ANËSOR IP20 2M



- AC21PW
- AC21ES
- AC21IW

- kuti IP20 2M
 - për montimin në sipërfaqe të elementeve
 - në përputhje me EN 60669-1, EN60884-1

BOX NO CUBO WITH BACK SIDE COVER IP20 2M
 - box IP20 2M
 - for surface mounting of elements
 - in accordance with EN 60669-1, EN60884-1



KUTI NO CUBO ME KAPAK TË PASMË ANËSOR IP20 4M



- AC41PW
- AC41ES
- AC41IW

- kuti IP20 4M
 - për montimin në sipërfaqe të elementeve
 - në përputhje me EN 60669-1, EN60884-1

BOX NO CUBO WITH BACK SIDE COVER IP20 4M
 - box IP20 4M
 - for surface mounting of elements
 - in accordance with EN 60669-1, EN60884-1



KUTI NO CUBO ME KAPAK TË PASMË ANËSOR IP20 6M



- AC61PW
- AC61ES
- AC61IW

- kuti IP20 6M
 - për montimin në sipërfaqe të elementeve
 - në përputhje me EN 60669-1, EN60884-1

BOX NO CUBO WITH BACK SIDE COVER IP20 6M
 - box IP20 6M
 - for surface mounting of elements
 - in accordance with EN 60669-1, EN60884-1



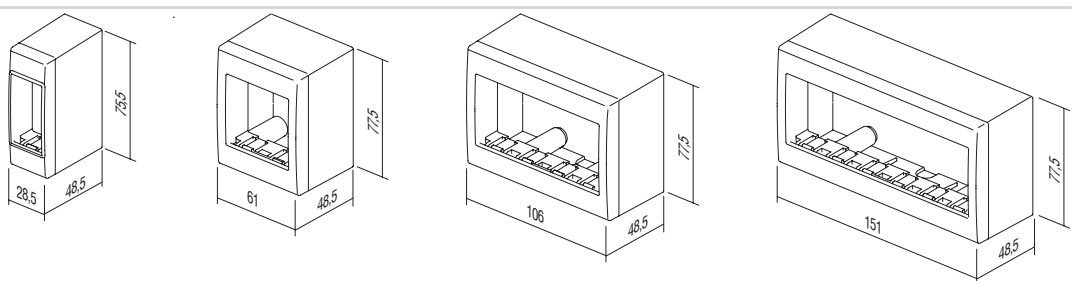

B O X E S C U B O I P 5 5 A Q



Iloji type	përshkrimi description	të dhënat teknike technical data	madhësia size	ngjyra colour
AQ20	KUTI ME MONTIM NË SIPËRFAQE TË JASHTME OUTDOOR SURFACE MOUNT BOX	IP55	2M	<input type="checkbox"/> PW e bardhë polare polar white
AQ22	KUTI ME MONTIM NË SIPËRFAQE TË JASHTME OUTDOOR SURFACE MOUNT BOX	IP55	2x2M	<input checked="" type="checkbox"/> GY gri grey
AQ30	KUTI ME MONTIM NË SIPËRFAQE TË JASHTME OUTDOOR SURFACE MOUNT BOX	IP55	3M	
AQ31	KUTI ME MONTIM NË SIPËRFAQE TË JASHTME OUTDOOR SURFACE MOUNT BOX	IP55	3M	

KUTI NO CUBO IP55 2M



- AQ20PW
 AQ20GY

- kuti IP55 2M
- për montim në sipërfaqe
- IP55 për përdorim në zona me lagështirë
- në përputhje me CEI 23-48, EN 60670

BOX NO CUBO IP55 2M

- box IP55 2M
- for surface mounting
- IP55 for usage in humid areas
- in accordance with CEI 23-48, EN 60670



KUTI NO CUBO IP55 2x2M



- AQ22PW
 AQ22GY

- kuti IP55 2x2M
- për montim në sipërfaqe
- IP55 për përdorim në zona me lagështirë
- në përputhje me CEI 23-48, EN 60670

BOX NO CUBO IP55 2x2M

- box IP55 2x2M
- for surface mounting
- IP55 for usage in humid areas
- in accordance with CEI 23-48, EN 60670



KUTI NO CUBO IP55 3M



- AQ30PW
 AQ30GY

- kuti IP55 3M
- për montim në sipërfaqe
- IP55 për përdorim në zona me lagështirë
- në përputhje me CEI 23-48, EN 60670

BOX NO CUBO IP55 3M

- box IP55 3M
- for surface mounting
- IP55 for usage in humid areas
- in accordance with CEI 23-48, EN 60670



KUTI PO CUBO IP55 3M



- AQ31PW
 AQ31GY

- kuti IP55 3M
- për montim rrafsh
- IP55 për përdorim në zona me lagështirë
- në përputhje me CEI 23-48, EN 60670

BOX PO CUBO IP55 3M

- box IP55 3M
- for flush mounting
- IP55 for usage in humid areas
- in accordance with CEI 23-48, EN 60670





□ AQ21PW

KUTI PO CUBO IP55 2M

- kuti IP55 2M
- mund të kombinohet me të gjitha elementet funksionale të Modul
- për montim rrafsh
- IP55 për përdorim në zona me lagështirë
- në përputhje me CEI 23-48, EN 60670

BOX PO CUBO IP55 2M

- box IP55 2M
- can be combined with all Modul functional elements
- for flush mounting
- IP55 for usage in humid areas
- in accordance with CEI 23-48, EN 60670

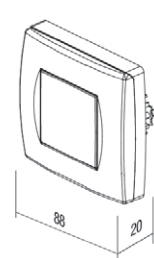
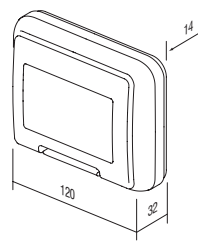
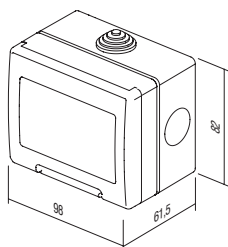
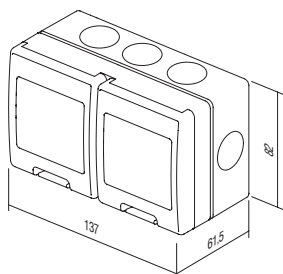
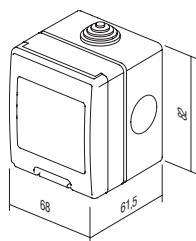

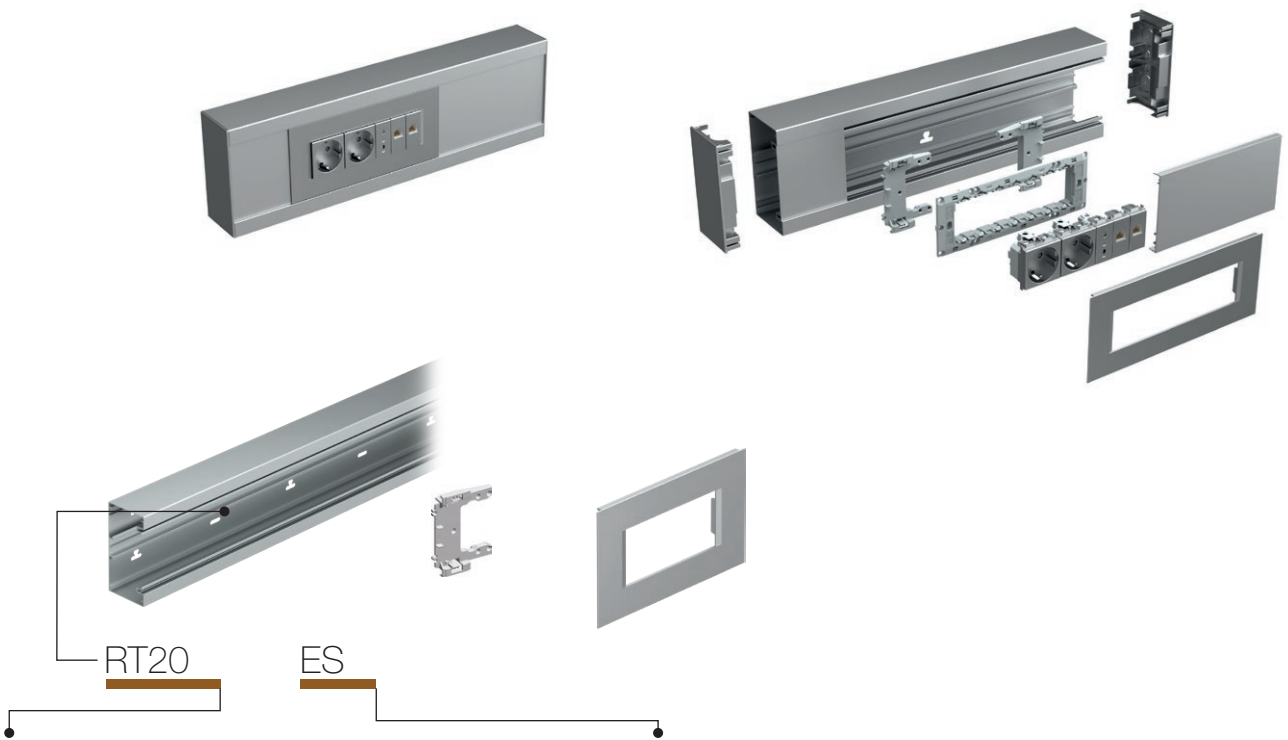

lloji type	përshkrimi description	madhësia size	ngjyra colour
RT10	PËRSHTATËS MA 92 ADAPTER MA 92	/	■ ES e argjendtë elox elox silver-mat
RT12	KAPAK MBULUES MA 92 COVER PLATE MA 92	2/3M	□ PW e bardhë mat (RAL 9016) white-mat
RT14	KAPAK MBULUES MA 92 COVER PLATE MA 92	4M	
⋮	⋮	⋮	

PËRSHTATËS MA 92



RT10

- përshtatës për fiksimin e kornizave të montimit 2/3M, 4M ose 7M në kanalina MA pa kuti
- secila kornizë montimi ka nevojë për dy përshtatës
- në përputhje me EN 50085-1

ADAPTER MA 92

- adapter for fixing mounting frames 2/3M, 4M or 7M on MA trunking without box
- each mounting frame needs two adapters
- in accordance with EN 50085-1

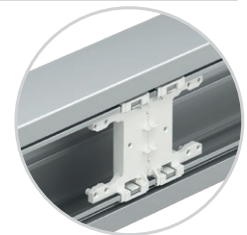

KAPAK MBULUES MA 92 2/3M



■ RT12ES
□ RT12PW

- kapak mbulues dekorativ MA 2/3M
- në përputhje me EN 50085-1

COVER PLATE MA 92 2/3M

- decorative cover plate MA 2/3M
- in accordance with EN 50085-1

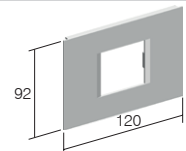

KAPAK MBULUES MA 92 4M



■ RT14ES
□ RT14PW

- kapak mbulues dekorativ MA 4M
- në përputhje me EN 50085-1

COVER PLATE MA 92 4M

- decorative cover plate MA 4M
- in accordance with EN 50085-1

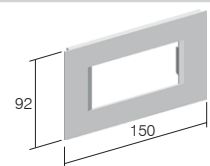

KAPAK MBULUES MA 92 7M



■ RT17ES
□ RT17PW

- kapak mbulues dekorativ MA 7M
- në përputhje me EN 50085-1

COVER PLATE MA 92 7M

- decorative cover plate MA 7M
- in accordance with EN 50085-1

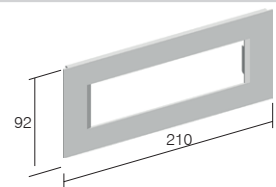



- RT20ES
- RT20PW

BAZË PËR KANALINA MA 130x65

- bazë për kanalina me profil alumini
- lartësia 130 mm, gjatësia 2 m
- DIN - formë shinë 35mm në fund
- në përputhje me EN 50085-1

TRUNKING BASE MA 130x65

- trunking base from extruded aluminium
- height 130mm, length 2m
- DIN - rail 35mm shape on bottom
- in accordance with EN 50085-1

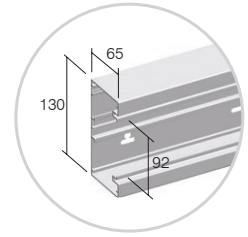

- RT21ES
- RT21PW

BAZË PËR KANALINA MA 165x65

- bazë për kanalina me profil alumini
- lartësia 165mm, gjatësia 2 m
- DIN - formë shinë 35mm në fund
- në përputhje me EN 50085-1

TRUNKING BASE MA 165x65

- trunking base from extruded aluminium
- height 165mm, length 2m
- DIN - rail 35mm shape on bottom
- in accordance with EN 50085-1

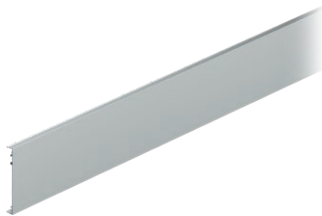
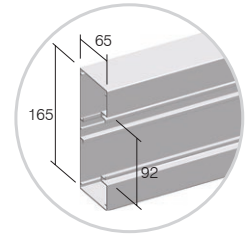

- RT25ES
- RT25PW

KAPAK I PËRPARMË MA 92

- kapak i përparmë prej profili alumini
- lartësia 92mm, gjatësia 2 m
- në përputhje me EN 50085-1

FRONT COVER MA 92

- front cover from extruded aluminium
- height 92mm, length 2m
- in accordance with EN 50085-1

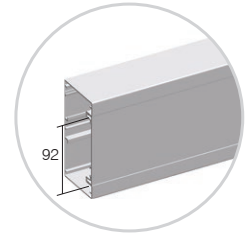

RT30

RAFT KABLLOSH MA 43

- raft kabllosh prej polimeresh
- thellësia 43mm, gjatësia 2 m
- në përputhje me EN 50085-1

CABLE SHELF MA 43

- cable shelf from extruded polymer
- depth 43mm, length 2m
- in accordance with EN 50085-1

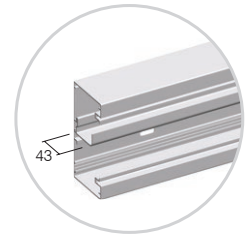

RT31

RAFT KABLLOSH MA 43 AL

- raft kabllosh prej profili alumini
- thellësia 43mm, gjatësia 2 m
- në përputhje me EN 50085-1

CABLE SHELF MA 43 AL

- cable shelf from extruded aluminium
- depth 43mm, length 2m
- in accordance with EN 50085-1

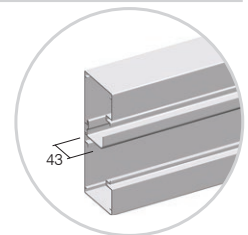

RT32

RAFT KABLLOSH MA 43 AL DYSH

- raft i dyfishtë kabllosh prej profili alumini
- thellësia 43mm, gjatësia 2 m
- në përputhje me EN 50085-1

CABLE SHELF MA 43 AL DOUBLE

- double cable shelf from extruded aluminium
- depth 43mm, length 2m
- in accordance with EN 50085-1

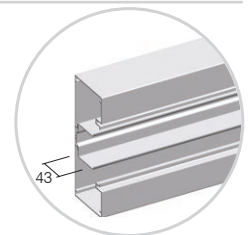

ELEMENT FUNDOR BLOKUES MA 130x65



- RT35ES
- RT35PW

- element fundor bllokues prej polimeri
- lartësia 130mm
- në përputhje me EN 50085-1

STOP END MA 130x65

- stop end element from polymer
- height 130mm
- in accordance with EN 50085-1

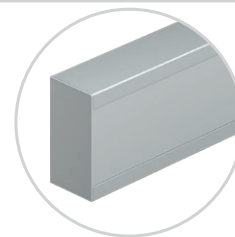

ELEMENT FUNDOR BLOKUES MA 165x65



- RT36ES
- RT36PW

- element fundor bllokues prej metali
- lartësia 165mm
- në përputhje me EN 50085-1

STOP END MA 165x65

- stop end element from metal
- height 165mm
- in accordance with EN 50085-1

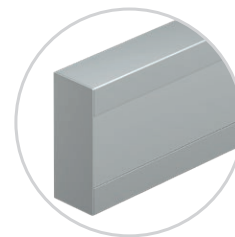

SET PJESË BASHKUESE MA 65



RT38

- pjesë bashkuese prej polimeri
- seti përmban dy pjesë dhe vida
- në përputhje me EN 50085-1

SET JOINING PIECE MA 65

- joining piece from polymer
- set contains two pieces and screws
- in accordance with EN 50085-1

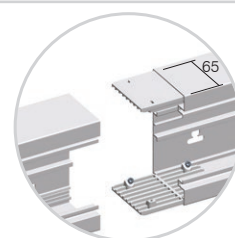

KËND UNIVERSAL MA 130x65



- RT40ES
- RT40PW

- element këndor universal
- lartësia 130mm
- në përputhje me EN 50085-1

UNIVERSAL CORNER MA 130x65

- universal corner element
- height 130mm
- in accordance with EN 50085-1

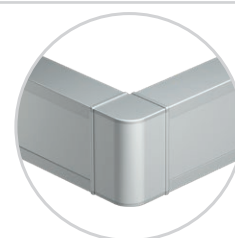

KËND UNIVERSAL MA 165x65



- RT41ES
- RT41PW

- element këndor universal
- lartësia 165mm
- në përputhje me EN 50085-1

UNIVERSAL CORNER MA 165x65

- universal corner element
- height 165mm
- in accordance with EN 50085-1

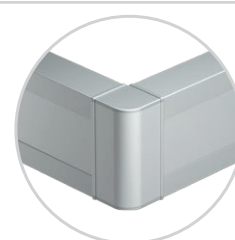

PJESË TOKËZIMI MA 2x A6.3



RT42

- pjesë tokëzimi për tokëzimin e bazës së kanalines dhe kapakut të përparmë
- në përputhje me EN 50085-1

EARTHING PIECE MA 2x A6.3

- earthing piece for earthing of trunking base and front cover
- in accordance with EN 50085-1

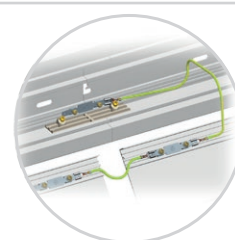

BËRRYL L MA 130x65

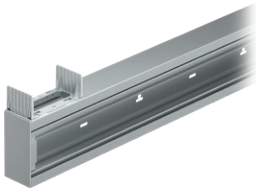

- RT43ES
- RT43PW

- bërryl universal L prej alumini
- lartësia 130 mm, gjatësia 400mm
- në përputhje me EN 50085-1

L-BEND MA 130x65

- universal L bend element from aluminium
- height 130mm, length 400mm
- in accordance with EN 50085-1

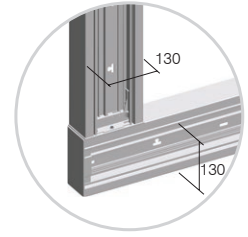

BËRRYL L MA 165x65

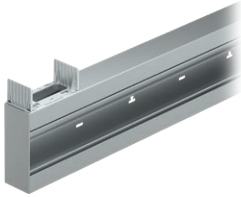

- RT44ES
- RT44PW

- bërryl universal L prej alumini
- lartësia 165mm, gjatësia 400mm
- lidhje në MA 130x65
- në përputhje me EN 50085-1

L-BEND MA 165x65

- universal L bend element from aluminium
- height 165mm, length 400mm
- connection on MA 130x65
- in accordance with EN 50085-1

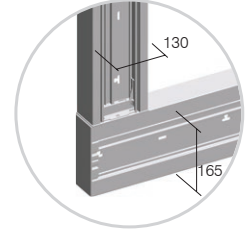

BËRRYL T MA 130x65



- RT45ES
- RT45PW

- bërryl universal T prej alumini
- lartësia 130 mm, gjatësia 400mm
- në përputhje me EN 50085-1

T-BEND MA 130x65

- universal T bend element from aluminium
- height 130mm, length 400mm
- in accordance with EN 50085-1

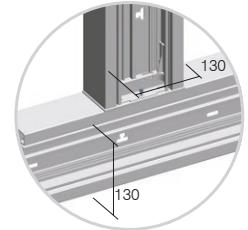

BËRRYL T MA 165x65



- RT46ES
- RT46PW

- bërryl universal T prej alumini
- lartësia 165mm, gjatësia 400mm
- lidhje në MA 130x65
- në përputhje me EN 50085-1

T-BEND MA 165x65

- universal T bend element from aluminium
- height 165mm, length 400mm
- connection on MA 130x65
- in accordance with EN 50085-1

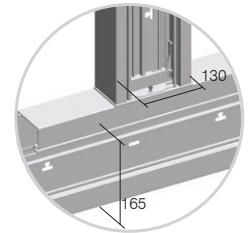

Kanalina MA bazohet në sistem modular dhe krijon kombinime elementesh 2M, 4M ose 7M

MA trunking is based on modular system making 2M, 4M or 7M combinations of elements

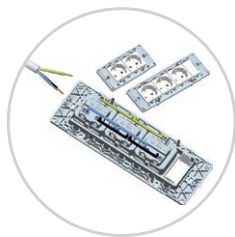

Në Modul ne ofrojmë elemente speciale për instalim të shpejtë

In Modul we provide special elements for quick installation

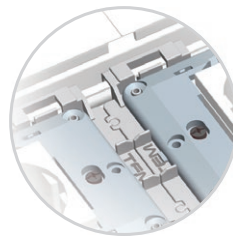

Me Përshtatësin MA ofrohet pozicionimi ekzakt pa përpjekje shtesë

With Adapter MA exact positioning without extra effort is provided

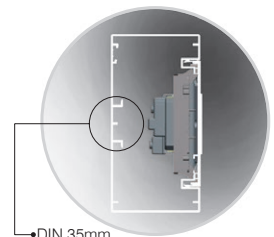

Montimi pa kuti nënkupton më shumë hapësirë për kablot, forma e bazës me shinë DIN EN-60715

Mounted without box means more space for cables, DIN-rail base shape EN-60715

T R U N K I N G S Y S T E M A L U M I N I U M



PLLAKËZ FIKSUESE MA NJËSHE 130x65



- RT50ES
- RT50PW

- pllakë fiksuese për fiksimin e bazës së kanalit MA130 në dysheme dhe/ose në tavan
- në përputhje me EN 50085-1

FIXING PLATE MA SINGLE 130x65

- fixing plate for fixing trunking base MA130 on the floor and/or on the ceiling
- in accordance with EN 50085-1



- RT51ES
- RT51PW

PLLAKËZ FIKSUESE MA DYSHE 130x65

- pllakëz fiksuese për fiksimin e dy bazave të kanalit MA130 në dysheme dhe/ose në tavan
- në përputhje me EN 50085-1

FIXING PLATE MA DOUBLE 130x65

- fixing plate for fixing two trunking bases MA130 on the floor and/or on the ceiling
- in accordance with EN 50085-1



KABINË SHËRBIMI MA 130x65x500



- RT52ES
- RT52PW

- kabinetë shërbimi MA
- lartësia 500mm
- kornizë montimi 7M e përfshirë
- në përputhje me EN 50085-1

SERVICE POST MA 130x65x500

- service post MA
- height 500mm
- mounting frame 7M included
- in accordance with EN 50085-1

KABINË SHËRBIMI MA DYSHE 130x130x500



- RT53ES
- RT53PW

- kabinetë shërbimi MA dyshe
- lartësia 500mm
- korniza montimi 7M të përfshira
- në përputhje me EN 50085-1

SERVICE POST MA DOUBLE 130x130x500

- service post MA double
- height 500mm
- mounting frames 7M included
- in accordance with EN 50085-1

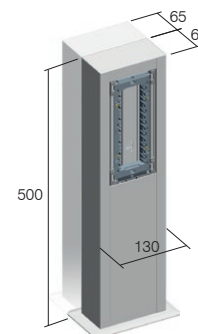

Ndërthurja e kabllit / Cable intersection mm ²	Prerje e tërthortë e kabllit / Cable cross-section (mm ²)				
	1 tel / 1 wire	2 tela / 2 wires	3 tela / 3 wires	4 tela / 4 wires	5 tela / 5 wires
1,5	44	111	121	144	169
2,5	49	133	157	169	211
4	58	169	183	211	256
6	68	196	225	256	307

Kanalina / Trunk	Kapaciteti i kanalit / Trunk capacity			
	MA 130x65 bosh / empty	MA 130x65 me çelësat dhe prizat Modul / with Modul switches and sockets	MA 165x65 bosh / empty	MA 130x65 me çelësat dhe prizat Modul / with Modul switches and sockets
kapaciteti capacity max ø	7600 mm ² 54 mm	5500 mm ² 2x42 mm	9900 mm ² 54 mm	7800 mm ² 2x42 mm

K U T I D Y S H E M E J E M T



RB33

shpërndarja

lloji type	përshkrimi description	të dhënat teknike technical data
RB30	KUTI DYSHEMEJE FLOOR BOX	MT 7
RB31	FLANXHË KUTIE DYSHEMEJE FLOOR BOX FLANGE	MT 7
RB33	KUTI DYSHEMEJE FLOOR BOX	MT 14
⋮	⋮	⋮

	RB30	RB33	RB36	RB40	RB43	RB46
a	170	260	350	170	260	350
b	260	260	260	260	260	260
X	140	230	320	140	230	320
Y	230	230	230	230	230	230

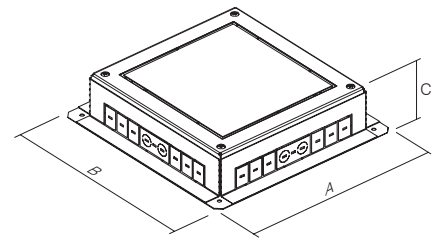
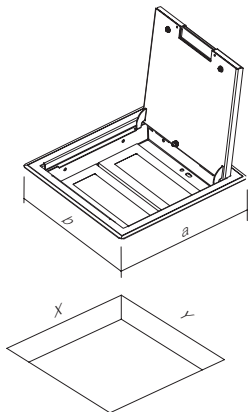

	RB31	RB34	RB37	RB41	RB44	RB47
A	250	340	430	250	340	430
B	340	340	340	340	340	340
C	95-125	95-125	95-125	125-150	125-150	125-150

KUTI DYSHEMEJE MT 7



RB30

- kuti dysHEMEJE MT 7
- metalike, ngjyrë argjendi RAL 9006
- kornizë montimi MODUL 7M e përfshirë
- dimensionet e montimit 140x230 mm, thellësia min. 95 mm
- trashësia e shtresës së dysHEMESË deri në 10 mm
- në përputhje me standardet EN 50085-1 dhe EN 50085-2-2

FLOOR BOX MT 7

- floor box MT 7
- metal, colour silver RAL 9006
- mounting frame MODUL 7M included
- mounting dimensions 140x230mm, depth min 95mm
- floor lining thickness up to 10mm
- in accordance with EN 50085-1 and EN 50085-2

KUTI DYSHEMEJE MT 7 H=88 mm



RB40

- kuti dysHEMEJE MT 7
- metalike, ngjyrë argjendi RAL 9006
- kornizë montimi MODUL 7M e përfshirë
- dimensionet e montimit 140x230 mm, thellësia min. 120mm
- trashësia e shtresës së dysHEMESË deri në 10 mm
- në përputhje me standardet EN 50085-1 dhe EN 50085-2-2

FLOOR BOX MT 7 H=88mm

- floor box MT 7
- metal, colour silver RAL 9006
- mounting frame MODUL 7M included
- mounting dimensions 140x230mm, depth min 120mm
- floor lining thickness up to 10mm
- in accordance with EN 50085-1 and EN 50085-2

FLANXHË KUTIE DYSHEMEJE MT 7

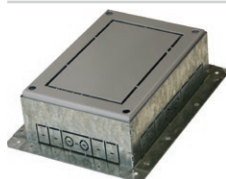

RB31

- flanxhë kutie dysHEMEJE për kapak kutie MT 7
- metalike, e galvanizuar
- për instalim në një dysHEME ose dysHEME dysHE
- lartësia e rregullueshme 95-125 mm
- në përputhje me standardet EN 50085-1 dhe EN 50085-2-2

FLOOR BOX FLANGE MT 7

- floor box flange for box cover MT 7
- metal, galvanized
- for installation in a floor or double floor
- adjustable height 95-125mm
- in accordance with EN 50085-1 and EN 50085-2

KUTI DYSHEMEJE MT 7 H=88 mm

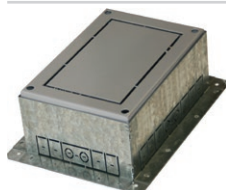

RB41

- flanxhë kutie dysHEMEJE për kapak kutie MT 7 H=88 mm
- metalike, e galvanizuar
- për instalim në një dysHEME ose dysHEME dysHE
- lartësia e rregullueshme 125-150mm
- në përputhje me standardet EN 50085-1 dhe EN 50085-2-2

FLOOR BOX FLANGE MT 7 H=88mm

- floor box flange for box cover MT 7 H=88mm
- metal, galvanized
- for installation in a floor or double floor
- adjustable height 125-150mm
- in accordance with EN 50085-1 and EN 50085-2

KUTI DYSHEMEJE MT 14



RB33

- kuti dysHEMEJE MT 14
- metalike, ngjyrë argjendi RAL 9006
- kornizë montimi MODUL 2x7M e përfshirë
- dimensionet e montimit 230x230 mm, thellësia min. 95 mm
- trashësia e shtresës së dysHEMESË deri në 10 mm
- në përputhje me standardet EN 50085-1 dhe EN 50085-2-2

FLOOR BOX MT 14

- floor box MT 14
- metal, colour silver RAL 9006
- mounting frame MODUL 2x7M included
- mounting dimensions 230x230mm, depth min 95mm
- floor lining thickness up to 10mm
- in accordance with EN 50085-1 and EN 50085-2

KUTI DYSHEMEJE MT 14 H=88 mm



RB43

- kuti dysHEMEJE MT 14
- metalike, ngjyrë argjendi RAL 9006
- kornizë montimi MODUL 2x7M e përfshirë
- dimensionet e montimit 230x230 mm, thellësia min. 120mm
- trashësia e shtresës së dysHEMESË deri në 10 mm
- në përputhje me standardet EN 50085-1 dhe EN 50085-2-2

FLOOR BOX MT 14 H=88mm

- floor box MT 14
- metal, colour silver RAL 9006
- mounting frames MODUL 2x7M included
- mounting dimensions 230x230mm, depth min 120mm
- floor lining thickness up to 10mm
- in accordance with EN 50085-1 and EN 50085-2

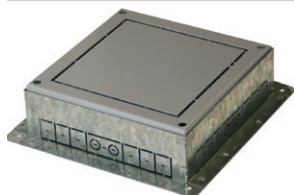

RB34

FLANXHË KUTIE DYSHEMEJE MT 14

- flanxhë kutie dysHEMEJE për kapak kutie MT 14
- metalike, e galvanizuar
- për instalim në një dysHEME ose dysHEME dyshe
- lartësia e rregullueshme 95-125 mm
- në përputhje me standardet EN 50085-1 dhe EN 50085-2-2

FLOOR BOX FLANGE MT 14

- floor box flange for box cover MT 14
- metal, galvanized
- for installation in a floor or double floor
- adjustable height 95-125mm
- in accordance with EN 50085-1 and EN 50085-2-2

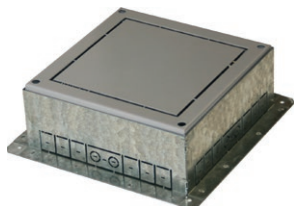

RB44

KUTI DYSHEMEJE MT 14 H=88 mm

- flanxhë kutie dysHEMEJE për kapak kutie MT 14 H=88 mm
- metalike, e galvanizuar
- për instalim në një dysHEME ose dysHEME dyshe
- lartësia e rregullueshme 125-150mm
- në përputhje me standardet EN 50085-1 dhe EN 50085-2-2

FLOOR BOX FLANGE MT 14 H=88mm

- floor box flange for box cover MT 14 H=88mm
- metal, galvanized
- for installation in a floor or double floor
- adjustable height 125-150mm
- in accordance with EN 50085-1 and EN 50085-2-2



RB36

KUTI DYSHEMEJE MT 21

- kuti dysHEMEJE MT 21
- metalike, ngjyrë argjendi RAL 9006
- korniza montimi MODUL 3x7M të përfshira
- dimensionet e montimit 320x230 mm, thellësia min. 95 mm
- trashësia e shtresës së dysHEMESË deri në 10 mm
- në përputhje me standardet EN 50085-1 dhe EN 50085-2-2

FLOOR BOX MT 21

- floor box MT 21
- metal, colour silver RAL 9006
- mounting frames MODUL 3x7M included
- mounting dimensions 320x230mm, depth min 95mm
- floor lining thickness up to 10mm
- in accordance with EN 50085-1 and EN 50085-2-2



RB46

KUTI DYSHEMEJE MT 21 H=88 mm

- kuti dysHEMEJE MT 21
- metalike, ngjyrë argjendi RAL 9006
- korniza montimi MODUL 3x7M të përfshira
- dimensionet e montimit 320x230 mm, thellësia min. 120mm
- trashësia e shtresës së dysHEMESË deri në 10 mm
- në përputhje me standardet EN 50085-1 dhe EN 50085-2-2

FLOOR BOX MT 21 H=88mm

- floor box MT 21
- metal, colour silver RAL 9006
- mounting frames MODUL 3x7M included
- mounting dimensions 320x230mm, depth min 120mm
- floor lining thickness up to 10mm
- in accordance with EN 50085-1 and EN 50085-2-2

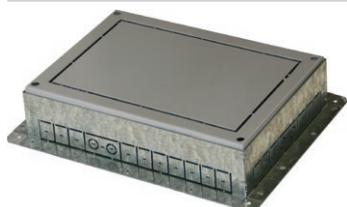

RB37

FLANXHË KUTIE DYSHEMEJE MT 21

- flanxhë kutie dysHEMEJE për kapak kutie MT 21
- metalike, e galvanizuar
- për instalim në një dysHEME ose dysHEME dyshe
- lartësia e rregullueshme 95-125 mm
- në përputhje me standardet EN 50085-1 dhe EN 50085-2-2

FLOOR BOX FLANGE MT 21

- floor box flange for box cover MT 21
- metal, galvanized
- for installation in a floor or double floor
- adjustable height 95-125mm
- in accordance with EN 50085-1 and EN 50085-2-2



RB47

KUTI DYSHEMEJE MT 21 H=88 mm

- flanxhë kutie dysHEMEJE për kapak kutie MT 21 H=88 mm
- metalike, e galvanizuar
- për instalim në një dysHEME ose dysHEME dyshe
- lartësia e rregullueshme 125-150mm
- në përputhje me standardet EN 50085-1 dhe EN 50085-2-2

FLOOR BOX FLANGE MT 21 H=88mm

- floor box flange for box cover MT 21 H=88mm
- metal, galvanized
- for installation in a floor or double floor
- adjustable height 125-150mm
- in accordance with EN 50085-1 and EN 50085-2-2

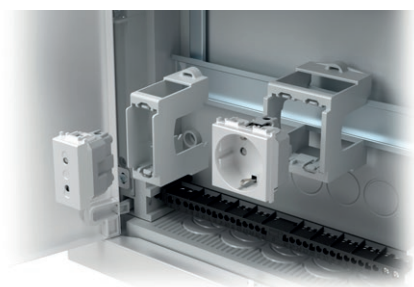

RB20

Iloji type	përshkrimi description	të dhënat teknike technical data
RB10	PËRSHTATËS PËR SHINË DIN ADAPTER FOR DIN RAIL	35mm 1M
RB11	PËRSHTATËS PËR SHINË DIN ADAPTER FOR DIN RAIL	35mm 2M
RB20	KUTI SHPËRNDARJEJE DISTRIBUTION BOX	MO 12+2
⋮	⋮	⋮

PËRSHTATËS PËR SHINË DIN 35 mm 1M



RB10

- përshtatës MODUL 1M
- për shinë DIN 35 mm
- në përputhje me EN 50022

ADAPTER FOR DIN RAIL 35mm 1M

- adapter MODUL 1M
- for DIN rail 35mm
- in accordance with EN 50022

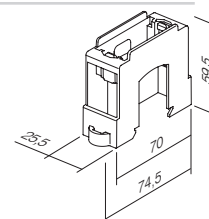

PËRSHTATËS PËR SHINË DIN 35 mm 2M



RB11

- përshtatës MODUL 2M
- për shinë DIN 35 mm
- në përputhje me EN 50022

ADAPTER FOR DIN RAIL 35mm 2M

- adapter MODUL 2M
- for DIN rail 35mm
- in accordance with EN 50022

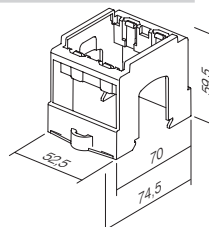

KUTI SHPËRNDARJEJE MO 12+2



RB20

- kuti shpërndarjeje MO me një radhë 12+2MU
- 400 V[~], Klasi II, IP40
- kornizë dhe kapak nivelues metalik, ngjyra e bardhë RAL 9016
- terminallet e nulit dhe tokëzimit brenda
- për montim në mur tulle
- në përputhje me EN 60670-1 dhe IEC 60670-24

DISTRIBUTION BOX MO 12+2

- distribution box MO single row 12+2MU
- 400V[~], Class II, IP40
- metal leveling frame and door, colour white RAL 9016
- neutral and earth conductor terminals enclosed
- for brick wall mounting
- in accordance with EN 60670-1 and IEC 60670-24

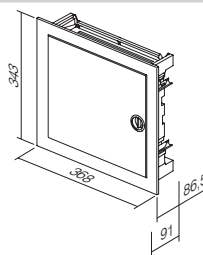

RB20V0

- për montim në mur bosh
- for hollow wall mounting

KUTI SHPËRNDARJEJE MO 24+4



RB21

- kuti shpërndarjeje MO me dy radhë 24+4MU
- 400 V[~], Klasi II, IP40
- kornizë dhe kapak nivelues metalik, ngjyra e bardhë RAL 9016
- terminallet e nulit dhe tokëzimit brenda
- për montim në mur tulle
- në përputhje me EN 60670-1 dhe IEC 60670-24

DISTRIBUTION BOX MO 24+4

- distribution box MO double row 24+4MU
- 400V[~], Class II, IP40
- metal leveling frame and door, colour white RAL 9016
- neutral and earth conductor terminals enclosed
- for brick wall mounting
- in accordance with EN 60670-1 and IEC 60670-24

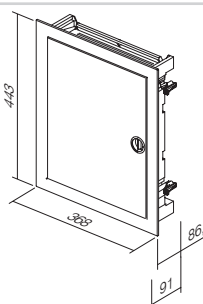

RB21V0

- për montim në mur bosh
- for hollow wall mounting

KUTI SHPËRNDARJEJE MO 36+6



RB22

- kuti shpërndarjeje MO me tri radhë 36+6 MU
- 400 V[~], Klasi II, IP40
- kornizë dhe kapak nivelues metalik, ngjyra e bardhë RAL 9016
- terminallet e nulit dhe tokëzimit brenda
- për montim në mur tulle
- në përputhje me EN 60670-1 dhe IEC 60670-24

DISTRIBUTION BOX MO 36+6

- distribution box MO triple row 36+6 MU
- 400V[~], Class II, IP40
- metal leveling frame and door, colour white RAL 9016
- neutral and earth conductor terminals enclosed
- for brick wall mounting
- in accordance with EN 60670-1 and IEC 60670-24

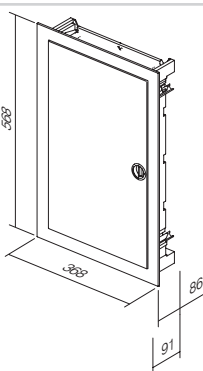

RB22V0

- për montim në mur bosh
- for hollow wall mounting

KUTI SHPËRNDARJEJE MO 48+8



RB23

- kuti shpërndarjeje MO me katër radhë 48+8 MU
- 400 V[~], Klasi II, IP40
- kornizë dhe kapak nivelues metalik, ngjyra e bardhë RAL 9016
- terminallet e nulit dhe tokëzimit brenda
- për montim në mur tulle
- në përputhje me EN 60670-1 dhe IEC 60670-24

DISTRIBUTION BOX MO 48+8

- distribution box MO quad row 48+8 MU
- 400V[~], Class II, IP40
- metal leveling frame and door, colour white RAL 9016
- neutral and earth conductor terminals enclosed
- for brick wall mounting
- in accordance with EN 60670-1 and IEC 60670-24

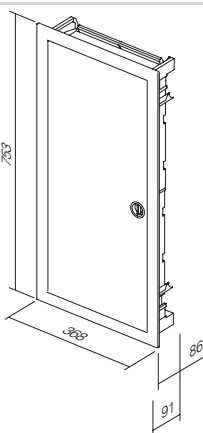

RB23V0

- për montim në mur bosh
- for hollow wall mounting

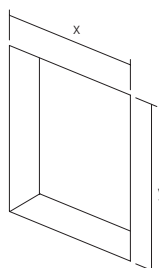

	RB20 RB20V0	RB21 RB21V0	RB22 RB22V0	RB23 RB23V0
x	314	314	314	314
y	314	414	539	724



ekonomik[®]



Planned for excellence
Style is essential



ERGO

METAL

SOFT

Një dizajn neutral, kompakt, elegant mund të përshtatet me çdo ambient pune ose ambient banimi. Nuk del jashtë enterierit, por në fakt përshtatet brenda në mënyrë harmonike.

A neutral, compact, elegant design is adjustable to every working or living area. It does not stick out from the interior, but rather harmonically fits into it.





Planifikuar për përsosmëri Stili është esencial



Një linjë e pastër është disi e harkuar - paraqitje ergonomike e menduar mirë posaçërisht për ju.
A pure line is slightly curved - well considered ergonomics especially for you.



Mund të zgjidhni mes sipërfaqeve të shkëlqyeshme dhe reflektuese dhe pamjes metalike moderne.
You can choose between shiny reflective surfaces and modern metallic look.



Butësia e formës do të përshtatet si në enterierët modernë ashtu edhe klasikë.
The softness of the form will find its place in modern as well as in classic interiors.

HARMONY

REFLEX

UV PROTECT

Dëshirat mund të jenë shumë të ndryshme. Prandaj, kemi zgjedhur me kujdes mundësitë për ju, që mund t'ju ofrojnë përgjigjen e duhur. Një paletë neutrale ngjyrash vetëm sa do ta plotësojë ambientin tuaj - nuk do ta kufizojë atë.

Desires can be very different. Therefore we have carefully selected possibilities for you, which can offer you the right answer. A neutral palette of colours will only complement your ambient - it will not restrict it.

Press and the world will spring to life
Colourful landscape between walls



Materialet polimere me shkëlqim në ngjyrë të bardhë dhe bezhë do të mundësojnë një atmosferë reflektive. Shiny polymer materials in white and beige colours enable reflective mood.



Veshja e përzgjedhur dekorative është në të njëjtën kohë moderne dhe neutrale. Selected decorative metallic coat is at the same time modern and neutral.

Shtypeni dhe bota do të vijë në jetë Peizazh shumëngjyrësh mes mureve



Për ata që duan të luajnë me ngjyrat e pastelës, Ekonomik Color paraqet një zgjidhje të përkryer. For those who want to play with pastel colours Ekonomik Color represents a perfect solution.



Fortësia dhe rezistenca e lartë ndaj efekteve të jashtme (UV) garantohen përmes materialeve duroplastike (linja Color). Robustness and high resistance to external effects (UV) are secured by duroplastic materials (Color line).

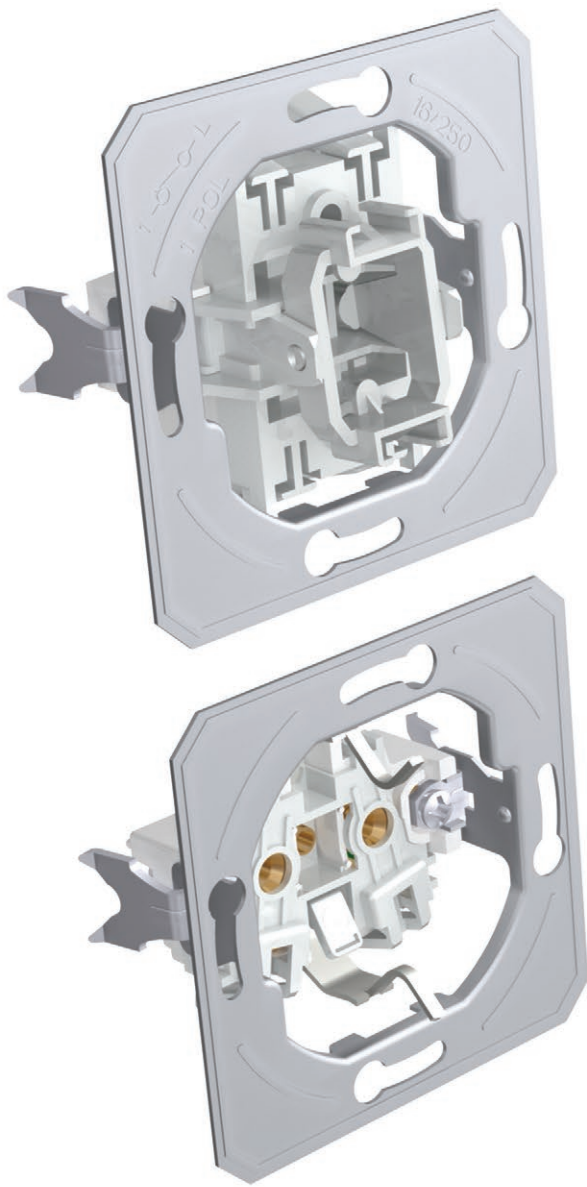

VERTICAL

HORIZONTAL

SAVE SPACE



Duke kombinuar ju kurseni hapësirë në mur. Kur përballeni me një hapësirë të kufizuar, "vertikalisht" është vendimi më i mirë.
With combining you save space on the wall. When faced with a limited space, »vertically« is the right decision.



Kombinoni siç dëshironi.
Combine as you please.



Elementet e dukshme mund të ndahen me lehtësi. Mjeshtrit e bojës do t'ju jenë mirënjohës.

Visible elements can be easily taken apart. Painters will be grateful to you.



Prolonge your day with a touch
Simplified living

Zgjateni ditën me një prekje Jetesë e thjeshtuar

Ekonomik është zgjidhja për sistemin e kutive të standardizuara të rumbullakëta të instalimit. Ai mund të përdoret për instalime të thjeshta si edhe më kërkuese, ndërtesa të reja dhe përshtatje. Sistemi karakterizohet nga kontakte për futje telash që kursejnë kohë gjatë instalimit të elementeve.

Ekonomik is a solution for the system of standardized round installations boxes. It can be used for simple as well as more demanding installations, new buildings and adaptations. The system is characterised by plug-in contacts which save time during installation of elements.

Mirëqenia në sigurinë e shtëpisë

Besim i plotë në ndërtimin e shkëlqyer

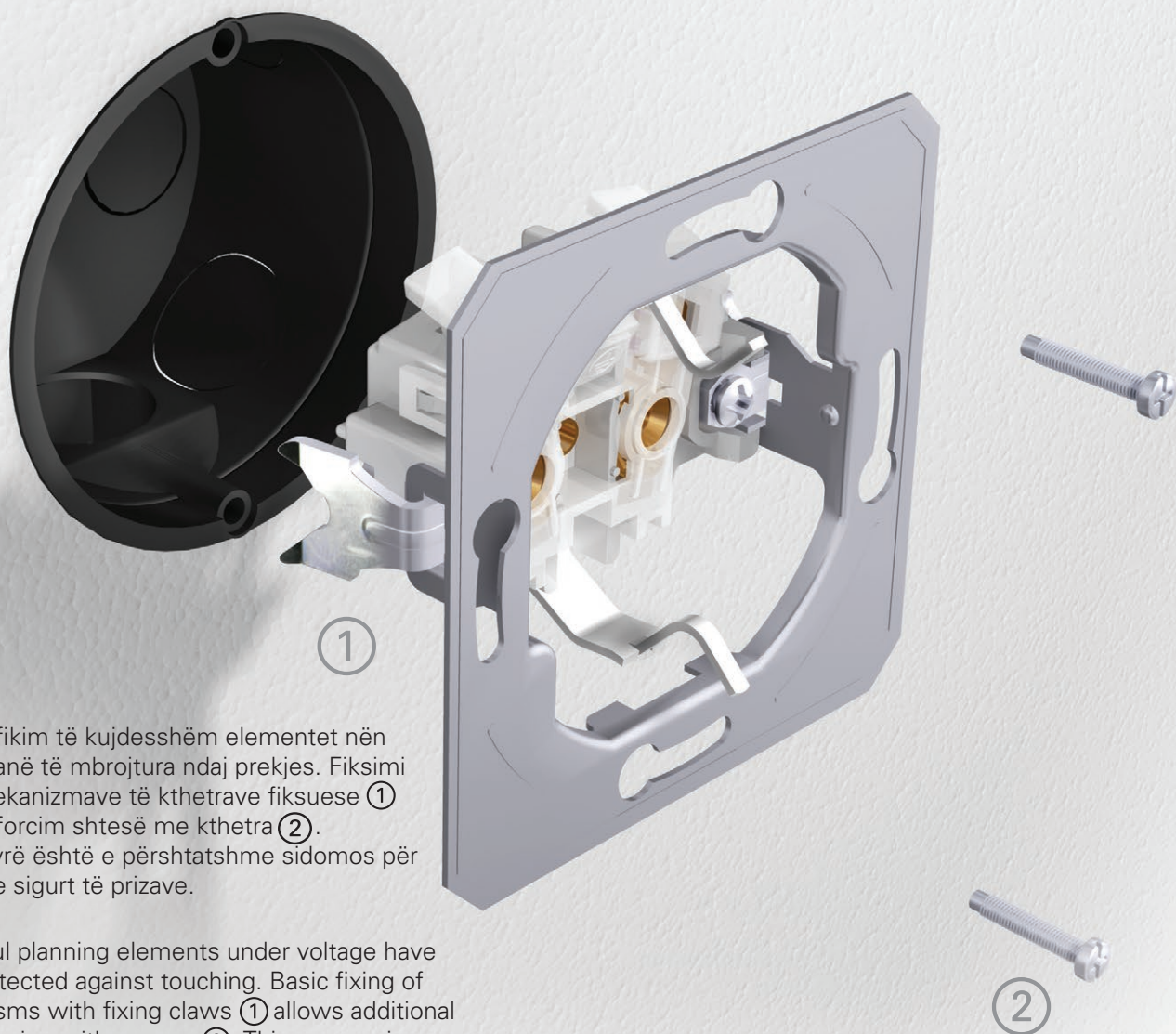

Me planifikim të kujdesshëm elementet nën tension janë të mbrojtura ndaj prekjes. Fiksimi bazë i mekanizmave të kthetrave fiksuese ① lejon përforcim shtesë me kthetra ②. Kjo mënyrë është e përshtatshme sidomos për fiksimin e sigurt të prizave.

By careful planning elements under voltage have been protected against touching. Basic fixing of mechanisms with fixing claws ① allows additional strengthening with screws ②. This manner is especially appropriate for safe and reliable fixing of sockets.

SIMPLE

FAST

FLEX

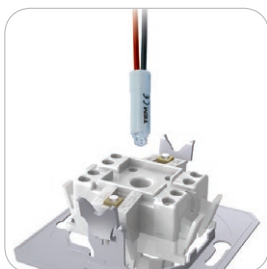

Një ndërtim çelësi i planifikuar mirë e bën të mundur ndriçimin e thjeshtë edhe më pas.
A well-planned switch construction makes easy illumination possible also subsequently.



Kontaktet për futjen e telave mundësojnë bashkim të shpejtë dhe të sigurt të telave. Dy tela me diametër të ndryshëm mund të bashkohen me të njëjtin kontakt.
Plug-in contacts enable quick and reliable attachment of wires. Two wires of different diameters can be attached to the same contact.

Kutitë e instalimit me montim të lehtë do ta bëjnë punën tuaj më të lehtë. Gjatësitë e dhura janë të garantuara.
Easy-fitting installation boxes will make your work easier. Proper lengths are guaranteed.



Feeling well in a safe shelter
Total confidence in a good construction

SAFE

THRUST

CERTIFIED

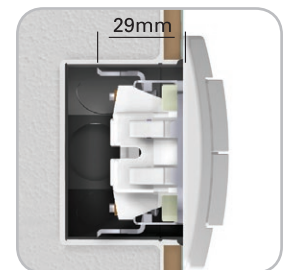

Kthetrat fiksuese mundësojnë fiksime më të thellë (gjithashtu përmes pllakave qeramike etj.)

Fixing claws enable deeper fixing (also through ceramic tiles, etc.)

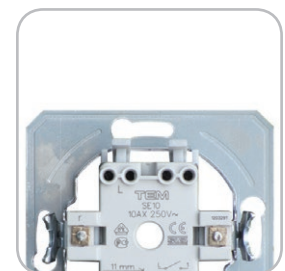

Të gjithë çelësat kanë identifikim të qartë në pjesën e pasme.

All switches have a clear identification in the back.

Çelësat janë testuar sipas standardeve ndërkombëtare që garantojnë siguri dhe jetëgjatësi.

Switches were tested according to international standards which guarantee safety and long life span.



Kontaktet prej aliazhi argjendi (Ag-Ni) garantojnë takim-stakim të sigurt.

Contacts made of silver alloy (Ag-Ni) guarantee safe switching.







TEM

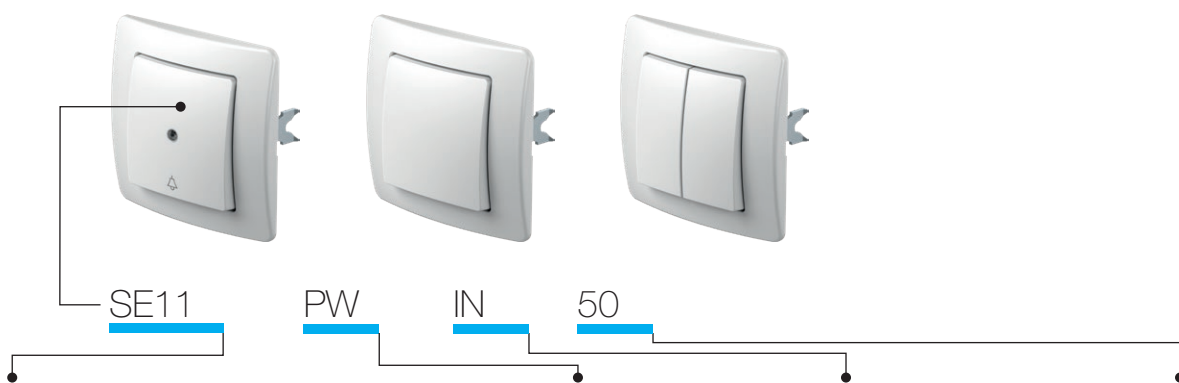



<p>ÇELËSAT SE SWITCHES SE</p>		188
<p>BUTONAT TE BUTTONS TE</p>		192
<p>NDRIÇUESIT IA ILLUMINATION IA</p>		193
<p>PRIZAT VE SOCKETS VE</p>		196
<p>KOMUNIKIMET KE COMMUNICATIONS KE</p>		199
<p>KAPAKËT PE COVERS PE</p>		204
<p>LIDHJET ELEKTRONIKE EE ELECTRONICS EE</p>		205
<p>AKSESORËT AE ACCESSORIES AE</p>		210
<p>KAPAKËT OE SURROUNDS OE</p>		212



Iloji type	përshkrimi description	të dhënat teknike technical data	ngjyra colour	të dhënat opsionale 1 optional data 1	të dhënat opsionale 2 optional data 2
SE10	ÇELËS ME 1 DREJTIM SWITCH 1WAY	10AX 250V~	<input type="checkbox"/> PW e bardhë polare polar white	 NT neutral neutral	 50
SE11	BUTON ME SHTYRPJE ME 1 DREJTIM PUSH BUTTON 1WAY	10A 250V~	<input type="checkbox"/> IW e bardhë fildishi ivory white	 IN treguesi indicator	 51
SE22	ÇELËS 2 POLAR SWITCH 2POLE	16AX 250V~	<input type="checkbox"/> ES e argjendtë elox elox silver		 03
...	<input type="checkbox"/> CO termoset i bardhë white thermostat		 04
...	<input type="checkbox"/> NB e zezë mesnate night black		...

ÇELËS ME 1 DREJTIM 10 A X 250 V~

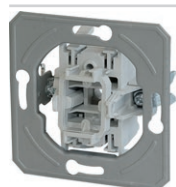

SE10

- 10 A X 250 V~, Iloji SE10
- në përputhje me EN 60669-1
- kontakte për futje telash 1,5-2,5 mm²

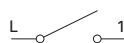

SWITCH 1WAY 10AX 250V~

- 10AX 250V~, type SE10
- in accordance with EN 60669-1
- plug-in contacts 1.5-2.5mm²

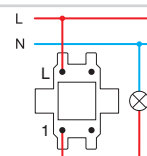

BUTON ME SHTYRPJE ME 1 DREJTIM 10A 250 V~



SE11

- 10A 250 V~, Iloji SE11
- në përputhje me EN 60669-1
- kontakte për futje telash 1,5-2,5 mm²

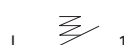

PUSH BUTTON 1WAY 10A 250V~

- 10A 250V~, type SE11
- in accordance with EN 60669-1
- plug-in contacts 1.5-2.5mm²

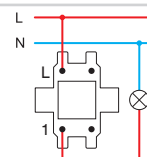

ÇELËS 2 POLAR 16 A X 250 V~

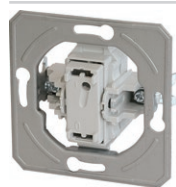

SE22

- 16 A X 250 V~, Iloji SE22
- në përputhje me EN 60669-1
- kontaktet e vidave 1,5-2,5 mm²
- vetëm në kombinim me butonin TE10__NT03

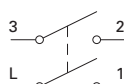

SWITCH 2POLE 16AX 250V~

- 16AX 250V~, type SE22
- in accordance with EN 60669-1
- screw contacts 1.5-2.5mm²
- only in combination with button TE10__NT03

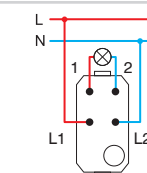

ÇELËS ME 2 POZICIONE - 1 DREJTIM 10 A X 250 V~



SE50

- 10 A X 250 V~, Iloji SE50
- në përputhje me EN 60669-1
- kontakte për futje telash 1,5-2,5 mm²



SWITCH 2GANG-1WAY 10AX 250V~

- 10AX 250V~, type SE50
- in accordance with EN 60669-1
- plug-in contacts 1.5-2.5mm²

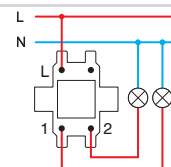

BUTON ME SHYTPJE ME 2 POZICIONE - 1 DREJTIM 10A 250 V~



SE51

- 10 A 250 V~, Iloji SE51
- në përputhje me EN 60669-1
- kontakte për futje telash 1,5-2,5 mm²

PUSH BUTTON 2GANG-1WAY 10A 250V~

- 10A 250V~, type SE51
- in accordance with EN 60669-1
- plug-in contacts 1.5-2.5mm²

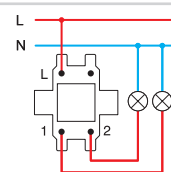
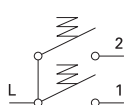

MBYLLËSE ÇELËSI 10 A X 250 V~



SE52

- 10 A X 250 V~, Iloji SE52
- në përputhje me EN 60669-1
- kontakte për futje telash 1,5-2,5 mm²
- me bllokim mekanik

SWITCH SHUTTERS 10AX 250V~

- 10AX 250V~, type SE52
- in accordance with EN 60669-1
- plug-in contacts 1.5-2.5mm²
- with mechanical interblock

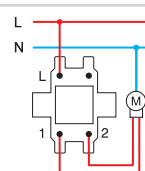
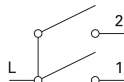

MBYLLËSE BUTONI ME SHYTPJE 10 A 250 V~



SE53

- 10A 250 V~, Iloji SE53
- në përputhje me EN 60669-1
- kontakte për futje telash 1,5-2,5 mm²
- me bllokim mekanik

PUSH BUTTON SHUTTERS 10A 250V~

- 10A 250V~, type SE53
- in accordance with EN 60669-1
- plug-in contacts 1.5-2.5mm²
- with mechanical interblock

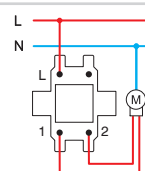
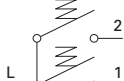

ÇELËS ME 2 DREJTIME 10 A X 250 V~



SE60

- 10 A X 250 V~, Iloji SE60
- në përputhje me EN 60669-1
- kontakte për futje telash 1,5-2,5 mm²

SWITCH 2WAY 10AX 250V~

- 10AX 250V~, type SE60
- in accordance with EN 60669-1
- plug-in contacts 1.5-2.5mm²

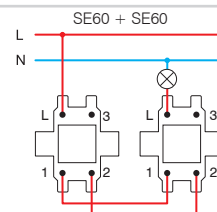
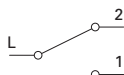

ÇELËS DYSH ME 2 DREJTIME 10 A X 250 V~



SE63

- 10 A X 250 V~, Iloji SE63
- në përputhje me EN 60669-1
- kontakte për futje telash 1,5-2,5 mm²

SWITCH DOUBLE 2WAY 10AX 250V~

- 10AX 250V~, type SE63
- in accordance with EN 60669-1
- plug-in contacts 1.5-2.5mm²

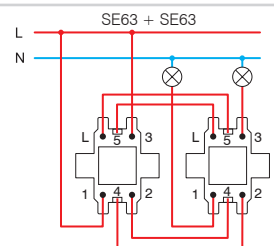
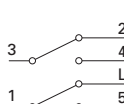

ÇELËS NDËRMJETËS 10 A X 250 V~

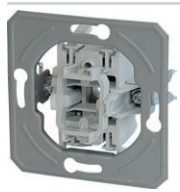

SE70

- 10 A X 250 V~, Iloji SE70
- në përputhje me EN 60669-1
- kontakte për futje telash 1,5-2,5 mm²

SWITCH INTERMEDIATE 10AX 250V~

- 10AX 250V~, type SE70
- in accordance with EN 60669-1
- plug-in contacts 1.5-2.5mm²

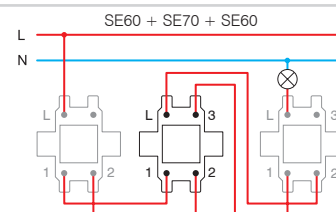
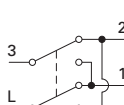

ÇELËS ME 1 DREJTIM 10 A X 250 V~



- SE10PW
- SE10IW
- SE10ES
- SE10CO
- SE10NB

- 10 A X 250 V~, Iloji SE10
 - në përputhje me EN 60669-1
 - kontakte për futje telash 1,5-2,5 mm²

SWITCH 1WAY 10AX 250V~
 - 10AX 250V~, type SE10
 - in accordance with EN 60669-1
 - plug-in contacts 1.5-2.5mm²



ÇELËS ME 1 DREJTIM 10 A X 250 V~ __ IN



- SE10PWIN
- SE10IWIN
- SE10ESIN
- SE10COIN
- SE10NBIN

- IN tregues
 - 10 A X 250 V~, Iloji SE10
 - në përputhje me EN 60669-1
 - kontakte për futje telash 1,5-2,5 mm²

SWITCH 1WAY 10AX 250V~ __ IN
 - IN indicator
 - 10AX 250V~, type SE10
 - in accordance with EN 60669-1
 - plug-in contacts 1.5-2.5mm²



BUTON ME SHTYPJE ME 1 DREJTIM 10A 250 V~



- SE11PW
- SE11IW
- SE11ES
- SE11CO
- SE11NB

- 10A 250 V~, Iloji SE11
 - në përputhje me EN 60669-1
 - kontakte për futje telash 1,5-2,5 mm²

PUSH BUTTON 1WAY 10A 250V~
 - 10A 250V~, type SE11
 - in accordance with EN 60669-1
 - plug-in contacts 1.5-2.5mm²



BUTON ME SHTYPJE ME 1 DREJTIM 10 A 250 V~ __ TI 50



- SE11PWTI50
- SE11IWTI50
- SE11ESTI50
- SE11COTI50
- SE11NBTI50

- TI 50 zile treguese+llambë neoni
 - 10A 250 V~, Iloji SE11
 - në përputhje me EN 60669-1
 - kontakte për futje telash 1,5-2,5 mm²

PUSH BUTTON 1WAY 10A 250V~ __ TI 50
 - TI 50 indicator bell+neon lamp
 - 10A 250V~, type SE11
 - in accordance with EN 60669-1
 - plug-in contacts 1.5-2.5mm²



BUTON ME SHTYPJE ME 1 DREJTIM 10 A 250 V~ __ TI 51



- SE11PWTI51
- SE11IWTI51
- SE11ESTI51
- SE11COTI51
- SE11NBTI51

- TI 51 dritë treguese+llambë neoni
 - 10A 250 V~, Iloji SE11
 - në përputhje me EN 60669-1
 - kontakte për futje telash 1,5-2,5 mm²

PUSH BUTTON 1WAY 10A 250V~ __ TI 51
 - TI 51 indicator light+neon lamp
 - 10A 250V~, type SE11
 - in accordance with EN 60669-1
 - plug-in contacts 1.5-2.5mm²



BUTON ME SHTYPJE ME 1 DREJTIM 10 A 250 V~ __ IL



- SE11PWIL
- SE11IWIL
- SE11ESIL
- SE11COIL
- SE11NBIL

- IL pllakë me mbishkrim
 - 10A 250 V~, Iloji SE11
 - në përputhje me EN 60669-1
 - kontakte për futje telash 1,5-2,5 mm²

PUSH BUTTON 1WAY 10A 250V~ __ IL
 - IL inscription plate
 - 10A 250V~, type SE11
 - in accordance with EN 60669-1
 - plug-in contacts 1.5-2.5mm²



ÇELËS 2 POLAR 16 A X 250 V~ __ IN 03



- SE22PWIN03
- SE22IWIN03
- SE22ESIN03
- SE22NBIN03

- IN 03 neutral 0-1
 - 16 A X 250 V~, Iloji SE22
 - në përputhje me EN 60669-1
 - kontaktet e vidave 1,5-2,5 mm²

SWITCH 2POLE 16AX 250V~ __ IN 03
 - IN 03 neutral 0-1
 - 16AX 250V~, type SE22
 - in accordance with EN 60669-1
 - screw contacts 1.5-2.5mm²





- SE50PW
- SE50IW
- SE50ES
- SE50CO
- SE50NB

ÇELËS ME 2 POZICIONE - 1 DREJTIM 10 A X 250 V~

- 10 A X 250 V~, Iloji SE50
- në përputhje me EN 60669-1
- kontakte për futje telash 1,5-2,5 mm²

SWITCH 2GANG-1WAY 10AX 250V~

- 10AX 250V~, type SE50
- in accordance with EN 60669-1
- plug-in contacts 1.5-2.5mm²



- SE51PW
- SE51IW
- SE51ES
- SE51CO
- SE51NB

BUTON ME SHTYPJJE ME 2 POZICIONE - 1 DREJTIM 10A 250 V~

- 10 A 250 V~, Iloji SE51
- në përputhje me EN 60669-1
- kontakte për futje telash 1,5-2,5 mm²

PUSH BUTTON 2GANG-1WAY 10A 250V~

- 10A 250V~, type SE51
- in accordance with EN 60669-1
- plug-in contacts 1.5-2.5mm²



- SE52PWNT09
- SE52IWNT09
- SE52ESNT09
- SE52CONT09
- SE52NBNT09

MBYLLËSE ÇELËSI 10 A X 250 V~ __ NT 09

- NT 09 neutral lart-poshtë
- 10 A X 250 V~, Iloji SE52
- në përputhje me EN 60669-1
- kontakte për futje telash 1,5-2,5 mm²
- me bllokim mekanik

SWITCH SHUTTERS 10AX 250V~ __ NT 09

- NT 09 neutral up-down
- 10AX 250V~, type SE52
- in accordance with EN 60669-1
- plug-in contacts 1.5-2.5mm²
- with mechanical interblock



- SE53PWNT09
- SE53IWNT09
- SE53ESNT09
- SE53CONT09
- SE53NBNT09

MBYLLËSE BUTONI ME SHTYPJJE 10 A 250 V~ __ NT 09

- NT 09 neutral lart-poshtë
- 10A 250 V~, Iloji SE53
- në përputhje me EN 60669-1
- kontakte për futje telash 1,5-2,5 mm²
- me bllokim mekanik

PUSH BUTTON SHUTTERS 10A 250V~ __ NT 09

- NT 09 neutral up-down
- 10A 250V~, type SE53
- in accordance with EN 60669-1
- plug-in contacts 1.5-2.5mm²
- with mechanical interblock



- SE60PW
- SE60IW
- SE60ES
- SE60CO
- SE60NB

ÇELËS ME 2 DREJTIME 10 A X 250 V~

- 10 A X 250 V~, Iloji SE60
- në përputhje me EN 60669-1
- kontakte për futje telash 1,5-2,5 mm²

SWITCH 2WAY 10AX 250V~

- 10AX 250V~, type SE60
- in accordance with EN 60669-1
- plug-in contacts 1.5-2.5mm²



- SE63PW
- SE63IW
- SE63ES
- SE63CO
- SE63NB

ÇELËS DYSH ME 2 DREJTIME 10 A X 250 V~

- 10 A X 250 V~, Iloji SE63
- në përputhje me EN 60669-1
- kontakte për futje telash 1,5-2,5 mm²

SWITCH DOUBLE 2WAY 10AX 250V~

- 10AX 250V~, type SE63
- in accordance with EN 60669-1
- plug-in contacts 1.5-2.5mm²



- SE70PW
- SE70IW
- SE70ES
- SE70CO
- SE70NB

ÇELËS NDËRMJETËS 10 A X 250 V~

- 10 A X 250 V~, Iloji SE70
- në përputhje me EN 60669-1
- kontakte për futje telash 1,5-2,5 mm²

SWITCH INTERMEDIATE 10AX 250V~

- 10AX 250V~, type SE70
- in accordance with EN 60669-1
- plug-in contacts 1.5-2.5mm²

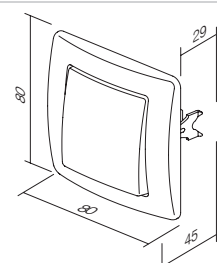
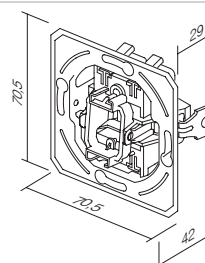

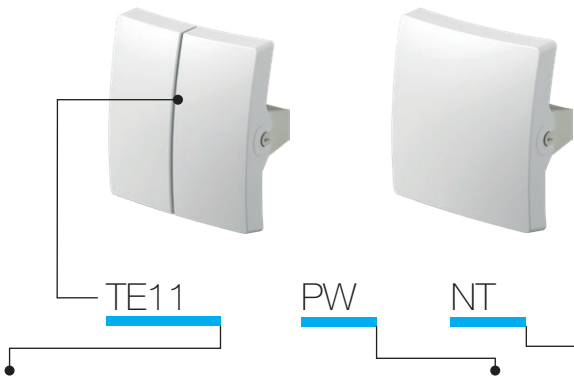

Iloji type	përshkrimi description	ngjyra colour	të dhënat opsionale 1 optional data 1	të dhënat opsionale 2 optional data 2
TE10	BUTON ME 1 POZICION BUTTON 1GANG	<input type="checkbox"/> PW e bardhë polare polar white	NT neutral neutral	50
TE11	BUTON ME 2 POZICIONE BUTTON 2GANG	<input type="checkbox"/> IW e bardhë fildishi ivory white	IN treguesi indicator	51
...	...	<input type="checkbox"/> ES e argjendtë elox elox silver		03
...	...	<input type="checkbox"/> CO termoset i bardhë white thermoset		04
...	...	<input type="checkbox"/> NB e zezë mesnate night black		...

BUTON ME 1 POZICION



- TE10PW
- TE10IW
- TE10ES
- TE10CO
- TE10NB

- buton bashkë me mbajtësen
BUTTON 1GANG
- button together with carrier



TREGUES BUTONI

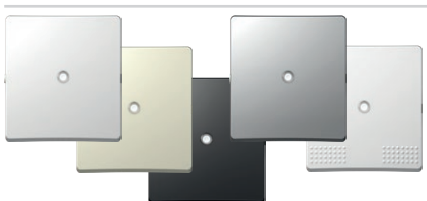

- TE10PWIN
- TE10IWIN
- TE10ESIN
- TE10COIN
- TE10NBIN

- buton bashkë me mbajtësen
BUTTON INDICATOR
- button together with carrier



BUTON ME KAPAK ME MBISHKRIM

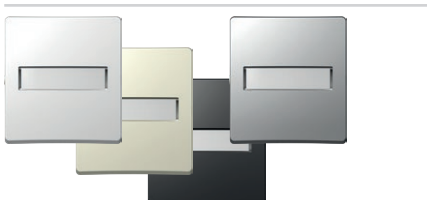

- TE13PWIL
- TE13IWIL
- TE13ESIL
- TE13NBIL

- buton bashkë me mbajtësen, me pllakë me mbishkrim
BUTTON WITH INSCRIPTION PLATE
- button together with carrier, with inscription plate



BUTON ME 2 POZICIONE



- TE11PW
- TE11IW
- TE11ES
- TE11CO
- TE11NB

- butoni me 2 pozicione bashkë me mbajtësen
BUTTON 2GANG
- button 2gang together with carrier

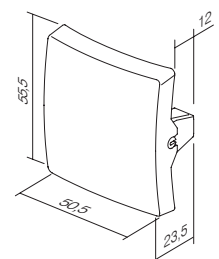
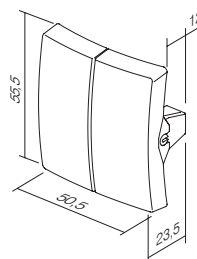

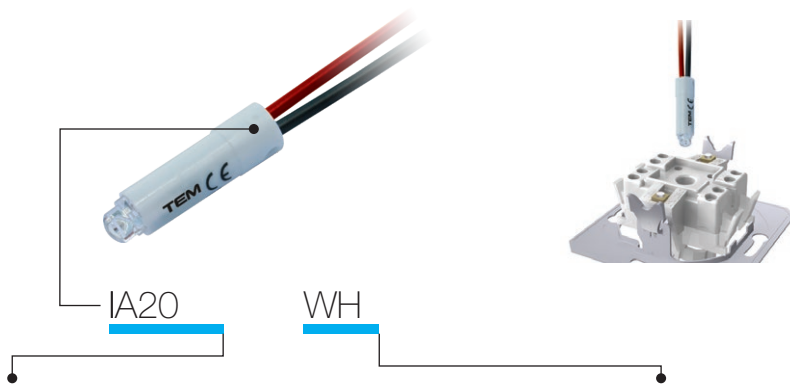

Iloji type	përshkrimi description	të dhënat teknike technical data	ngjyra colour
IA10	LLAMBË NEONI NEON LAMP	230V~ 0,34W	<input type="checkbox"/> WH e bardhë white
IA20	LLAMBË LED LED LAMP	230V~ 0,40W	<input checked="" type="checkbox"/> BL blu blue
IA21	LLAMBË LED LED LAMP	24V AC/DC 0,20W	<input checked="" type="checkbox"/> RD e kuqe red
·	·	·	<input checked="" type="checkbox"/> GR e gjelbër green
·	·	·	<input checked="" type="checkbox"/> OR portokalli orange

LLAMBË NEONI 230 V~ 0,34 W

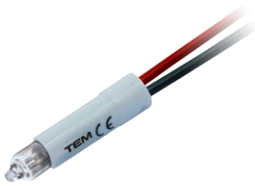

IA10OR

- si tregues, për ndriçim ose ndriçim konstant të çelësit
- në kombinim me butonin me tregues

NEON LAMP 230V~ 0,34W

- for indication, illumination or constant illumination of switch
- in combination with button with indicator

LLAMBË LED 230 V AC/DC 0,40 W



IA20WH
 IA20GR
 IA20RD
 IA20BL

- si tregues, për ndriçim ose ndriçim konstant të çelësit
- në kombinim me butonin me tregues

LED LAMP 230V AC/DC 0,40W

- for indication, illumination or constant illumination of switch
- in combination with button with indicator

LLAMBË LED 24V AC/DC 0,20W

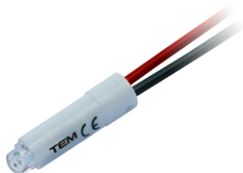

IA21WH
 IA21RD

- si tregues, për ndriçim ose ndriçim konstant të çelësit
- në kombinim me butonin me tregues

LED LAMP 24V AC/DC 0,20W

- for indication, illumination or constant illumination of switch
- in combination with button with indicator

LLAMBË LED 12V AC/DC 0,10W



IA22WH
 IA22RD

- si tregues, për ndriçim ose ndriçim konstant të çelësit
- në kombinim me butonin me tregues

LED LAMP 12V AC/DC 0,10W

- for indication, illumination or constant illumination of switch
- in combination with button with indicator

* Treguesi /
Indication

Ndriçimi /
Illumination

* Ndriçim konstant /
Illumination always on

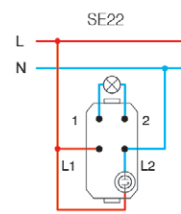
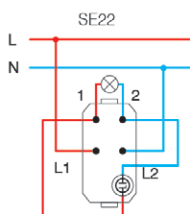
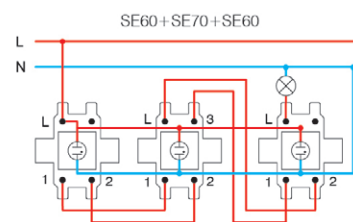
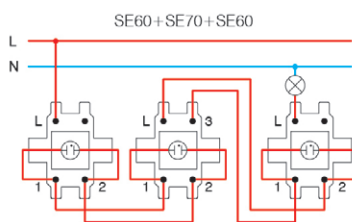
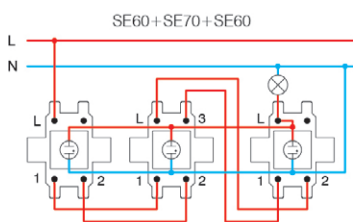
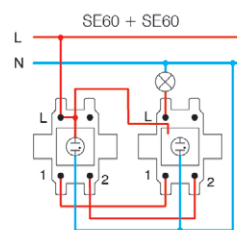
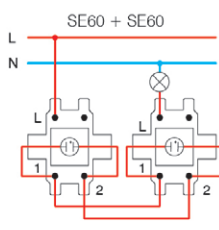
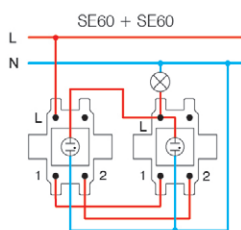
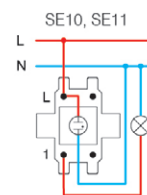
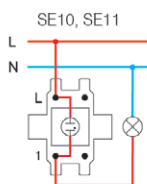
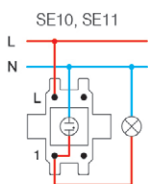

* skema elektrike për llambë kompakte fluide (CFL, LED)
wiring scheme for energy saving lamps (CFL, LED)

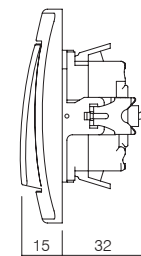

S O C K E T S V E

VE11 PT XO KS

lloji type	përshkrimi description	të dhënat teknike technical data	të dhënat opsionale 1 optional data 1	të dhënat opsionale 2 optional data 2
VE10	PRIZË SCHUKO SOCKET SCHUKO	2P+E 16A 250V~	XO pa kapak mbulues without cover plate	KS kontaktet me rrymën të mbuluara shuttered live contacts
VE11	PRIZË SCHUKO+KAPAK SOCKET SCHUKO+COVER	2P+E 16A 250V~		
VE12	PRIZË SCHUKO SOCKET SCHUKO	2P+E 16A 250V~ BV	KS kontaktet me rrymën të mbuluara shuttered live contacts	
⋮	⋮	⋮		
⋮	⋮	⋮		

ngjyra
colour

<input type="checkbox"/> PW e bardhë polare polar white	<input checked="" type="checkbox"/> PT e bardhë+transparente white+transparent	<input type="checkbox"/> PP e bardhë+e bardhë white+white
<input checked="" type="checkbox"/> IW e bardhë fildishi ivory white	<input checked="" type="checkbox"/> IT e fildishtë+transparente ivory+transparent	<input checked="" type="checkbox"/> II e fildishtë+e fildishtë ivory+ivory
<input type="checkbox"/> ES e argjendtë elox elox silver	<input checked="" type="checkbox"/> ST e argjendtë+transparente silver+transparent	<input type="checkbox"/> SS e argjendtë+e argjendtë silver+silver
<input type="checkbox"/> CO termoset i bardhë white thermoset	<input checked="" type="checkbox"/> CT e bardhë+transparente white+transparent	<input checked="" type="checkbox"/> BB e zezë+e zezë black+black
<input checked="" type="checkbox"/> NB e zezë mesnate night black	<input checked="" type="checkbox"/> BT e zezë+transparente black+transparent	<input checked="" type="checkbox"/> RR e kuqe+e kuqe red+red
<input checked="" type="checkbox"/> RD e kuqe red	<input checked="" type="checkbox"/> RT e kuqe+transparente red+transparent	<input checked="" type="checkbox"/> GG e gjelbër+e gjelbër green+green
<input checked="" type="checkbox"/> GR e gjelbër green	<input checked="" type="checkbox"/> GT e gjelbër+transparente green+transparent	<input checked="" type="checkbox"/> OO portokalli+portokalli orange+orange
<input checked="" type="checkbox"/> OR portokalli orange	<input checked="" type="checkbox"/> OT portokalli+transparente orange+transparent	



schuko - në përputhje me EN 60884-1, CEE7 (fleta e standardit III)

Franceze - në përputhje me NF C 61-314 (fleta e standardit V)

schuko - in accordance with EN 60884-1, CEE7 (standard sheet III)

French - in accordance with NF C 61-314 (standard sheet V)

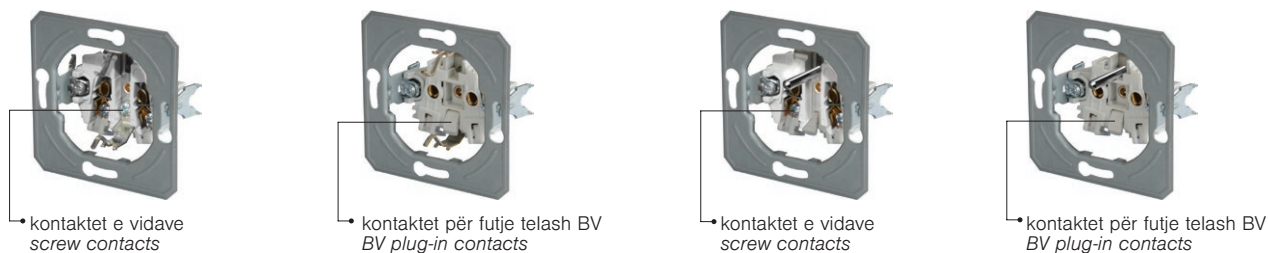

PRIZË SCHUKO 2P+E 16 A 250 V~ __ XO

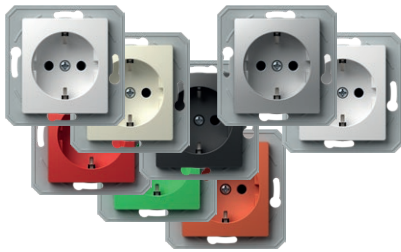

- VE10PWXO
- VE10IWXO
- VE10ESXO
- VE10COXO
- VE10NBXO
- VE10RDXO
- VE10GRXO
- VE10ORXO

- kontaktet e vidave 1,5-2,5 mm²
- XO pa kapak mbulues
- 2P+E schuko
- 16 A 250 V~, Iloji VE10

SOCKET SCHUKO 2P+E 16A 250V~ __ XO

- screw contacts 1.5-2.5mm²
- XO without surround
- 2P+E schuko
- 16A 250V~, type VE10



PRIZË SCHUKO+KAPAK 2P+E 16 A 250 V~ __ XO

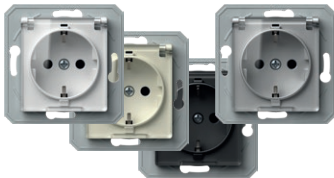

- VE11PTXO
- VE11ITXO
- VE11STXO
- VE11BTXO

- kontaktet e vidave 1,5-2,5 mm²
- XO pa kapak mbulues
- 2P+E schuko+kapak
- 16 A 250 V~, Iloji VE11

SOCKET SCHUKO+COVER 2P+E 16A 250V~ __ XO

- screw contacts 1.5-2.5mm²
- XO without surround
- 2P+E schuko+cover
- 16A 250V~, type VE11



PRIZË SCHUKO 2P+E 16 A 250 V~ BV __ XO



- VE12PWXO
- VE12IWXO
- VE12ESXO
- VE12COXO
- VE12NBXO
- VE12RDXO
- VE12GRXO
- VE12ORXO

- BV kontakte për futje telash 1,5-2,5 mm²
- XO pa kapak mbulues
- 2P+E schuko
- 16 A 250 V~, Iloji VE12

SOCKET SCHUKO 2P+E 16A 250V~ BV __ XO

- BV plug-in contacts 1.5-2.5mm²
- XO without surround
- 2P+E schuko
- 16A 250V~, type VE12



PRIZË SCHUKO+KAPAK 2P+E 16 A 250 V~ BV __ XO

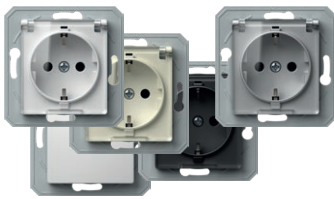

- VE13PTXO
- VE13ITXO
- VE13STXO
- VE13BTXO

- BV kontakte për futje telash 1,5-2,5 mm²
- XO pa kapak mbulues
- 2P+E schuko+kapak
- 16 A 250 V~, Iloji VE13

SOCKET SCHUKO+COVER 2P+E 16A 250V~ BV __ XO

- BV plug-in contacts 1.5-2.5mm²
- XO without surround
- 2P+E schuko+cover
- 16A 250V~, type VE13



PRIZË SCHUKO 2P+E 16 A 250 V~



- VE10PW
- VE10IW
- VE10ES
- VE10CO
- VE10NB

- kontaktet e vidave 1,5-2,5 mm²
- 2P+E schuko
- 16 A 250 V~, Iloji VE10

SOCKET SCHUKO 2P+E 16A 250V~

- screw contacts 1.5-2.5mm²
- 2P+E schuko
- 16A 250V~, type VE10



PRIZË SCHUKO+KAPAK 2P+E 16 A 250 V~

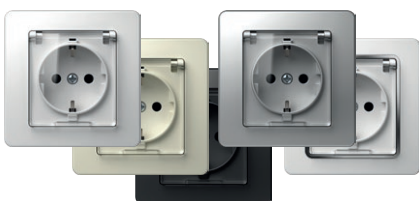

- VE11PT
- VE11IT
- VE11ST
- VE11CT
- VE11BT

- kontaktet e vidave 1,5-2,5 mm²
- 2P+E schuko+kapak
- 16 A 250 V~, Iloji VE11

SOCKET SCHUKO+COVER 2P+E 16A 250V~

- screw contacts 1.5-2.5mm²
- 2P+E schuko+cover
- 16A 250V~, type VE11



PRIZË SCHUKO 2P+E 16 A 250 V~ BV



- VE12PW
- VE12IW
- VE12ES
- VE12CO
- VE12NB

- BV kontakte për futje telash 1,5-2,5 mm²
- 2P+E schuko
- 16 A 250 V~, Iloji VE12

SOCKET SCHUKO 2P+E 16A 250V~ BV

- BV plug-in contacts 1.5-2.5mm²
- 2P+E schuko
- 16A 250V~, type VE12



PRIZË SCHUKO+KAPAK 2P+E 16 A 250 V~ BV



- VE13PT
- VE13IT
- VE13ST
- VE13CT
- VE13BT

- BV kontakte për futje telash 1,5-2,5 mm²
- 2P+E schuko+kapak
- 16 A 250 V~, Iloji VE13

SOCKET SCHUKO+COVER 2P+E 16A 250V~ BV

- BV plug-in contacts 1.5-2.5mm²
- 2P+E schuko+cover
- 16A 250V~, type VE13





- VE40PWXO
- VE40IWXO
- VE40ESXO
- VE40COXO
- VE40NBXO
- VE40RDXO
- VE40GRXO
- VE40ORXO

PRIZË FRANCEZE 2P+E 16 A 250 V~ __ XO

- kontaktet e vidave 1,5-2,5 mm²
- XO pa kapak mbulues
- 2P+E Franceze
- 16 A 250 V~, Iloji VE40

SOCKET FRENCH 2P+E 16A 250V~ __ XO

- screw contacts 1.5-2.5mm²
- XO without surround
- 2P+E French
- 16A 250V~, type VE40

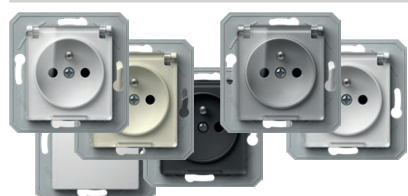

- VE41PTXO
- VE41ITXO
- VE41STXO
- VE41PTXO
- VE41BTXO
- VE41PPXO

PRIZË FRANCEZE+KAPAK 2P+E 16 A 250 V~ __ XO

- kontaktet e vidave 1,5-2,5 mm²
- XO pa kapak mbulues
- 2P+E Franceze+kapak
- 16 A 250 V~, Iloji VE41

SOCKET FRENCH+COVER 2P+E 16A 250V~ __ XO

- screw contacts 1.5-2.5mm²
- XO without surround
- 2P+E French+cover
- 16A 250V~, type VE41



- VE42PWXO
- VE42IWXO
- VE42ESXO
- VE42COXO
- VE42NBXO
- VE42RDXO
- VE42GRXO
- VE42ORXO

PRIZË FRANCEZE 2P+E 16 A 250 V~ BV __ XO

- BV kontakte për futje telash 1,5-2,5 mm²
- XO pa kapak mbulues
- 2P+E Franceze
- 16 A 250 V~, Iloji VE42

SOCKET FRENCH 2P+E 16A 250V~ BV __ XO

- BV plug-in contacts 1.5-2.5mm²
- XO without surround
- 2P+E French
- 16A 250V~, type VE42



- VE43PTXO
- VE43ITXO
- VE43STXO
- VE43PTXO
- VE43BTXO
- VE43PPXO

PRIZË FRANCEZE+KAPAK 2P+E 16 A 250 V~ BV __ XO

- BV kontakte për futje telash 1,5-2,5 mm²
- XO pa kapak mbulues
- 2P+E Franceze+kapak
- 16 A 250 V~, Iloji VE43

SOCKET FRENCH+COVER 2P+E 16A 250V~ BV __ XO

- BV plug-in contacts 1.5-2.5mm²
- XO without surround
- 2P+E French+cover
- 16A 250V~, type VE43



- VE40PW
- VE40IW
- VE40ES
- VE40CO
- VE40NB

PRIZË FRANCEZE 2P+E 16 A 250 V~

- kontaktet e vidave 1,5-2,5 mm²
- 2P+E Franceze
- 16 A 250 V~, Iloji VE40

SOCKET FRENCH 2P+E 16A 250V~

- screw contacts 1.5-2.5mm²
- 2P+E French
- 16A 250V~, type VE40



- VE41PT
- VE41IT
- VE41ST
- VE41CT
- VE41BT

PRIZË FRANCEZE+KAPAK 2P+E 16 A 250 V~

- kontaktet e vidave 1,5-2,5 mm²
- 2P+E Franceze+kapak
- 16 A 250 V~, Iloji VE41

SOCKET FRENCH+COVER 2P+E 16A 250V~

- screw contacts 1.5-2.5mm²
- 2P+E French+cover
- 16A 250V~, type VE41



- VE42PW
- VE42IW
- VE42ES
- VE42CO
- VE42NB

PRIZË FRANCEZE 2P+E 16 A 250 V~ BV

- BV kontakte për futje telash 1,5-2,5 mm²
- 2P+E Franceze
- 16 A 250 V~, Iloji VE42

SOCKET FRENCH 2P+E 16A 250V~ BV

- BV plug-in contacts 1.5-2.5mm²
- 2P+E French
- 16A 250V~, type VE42



- VE43PT
- VE43IT
- VE43ST
- VE43CT
- VE43BT

PRIZË FRANCEZE+KAPAK 2P+E 16 A 250 V~ BV

- BV kontakte për futje telash 1,5-2,5 mm²
- 2P+E Franceze+kapak
- 16 A 250 V~, Iloji VE43

SOCKET FRENCH+COVER 2P+E 16A 250V~ BV

- BV plug-in contacts 1.5-2.5mm²
- 2P+E French+cover
- 16A 250V~, type VE43





- VE16PWKS
- VE16IWKS
- VE16ESKS
- VE16NBKS

PRIZË SCHUKO DYSHE 2P+E 16 A 250 V~

- 2P+E schuko dyshe
- 16 A 250 V~, lloji VE16
- në përputhje me IEC 60884-1, CEE7
- kontaktet e vidave 1,5-2,5 mm²
- kontaktet KS me rrymën të mbuluara

SOCKET SCHUKO DOUBLE 2P+E 16A 250V~

- 2P+E schuko double
- 16A 250V~, type VE16
- in accordance with IEC 60884-1, CEE7
- screw contacts 1.5-2.5 mm²
- KS shuttered live contacts



- VE46PWKS
- VE46IWKS
- VE46ESKS
- VE46NBKS

PRIZË FRANCEZE DYSHE 2P+E 16 A 250 V~

- 2P+E franceze dyshe
- 16 A 250 V~, lloji VE46
- në përputhje me IEC 60884-1, CEE7; NF C 61-314, CSN 33 2318; PN-E 93201
- kontaktet e vidave 1,5-2,5 mm²
- kontaktet KS me rrymën të mbuluara

SOCKET FRENCH DOUBLE 2P+E 16A 250V~

- 2P+E French double
- 16A 250V~, type VE46
- in accordance with IEC 60884-1, CEE7; NF C 61-314, CSN 33 2318; PN-E 93201
- screw contacts 1.5-2.5 mm²
- KS shuttered live contacts



- VE30PW
- VE30IW
- VE30ES
- VE30NB

PRIZË 2P 16 A 250 V~

- 2P pa kontakt për tokëzimin
- 16 A 250 V~
- në përputhje me EN 60884-1, CEE7 (fleta e standardit I)
- kontaktet e vidave 1,5-2,5 mm²

SOCKET 2P 16A 250V~

- 2P without earthing contact
- 16A 250V~
- in accordance with EN 60884-1, CEE7 (standard sheet I)
- screw contacts 1.5-2.5mm²

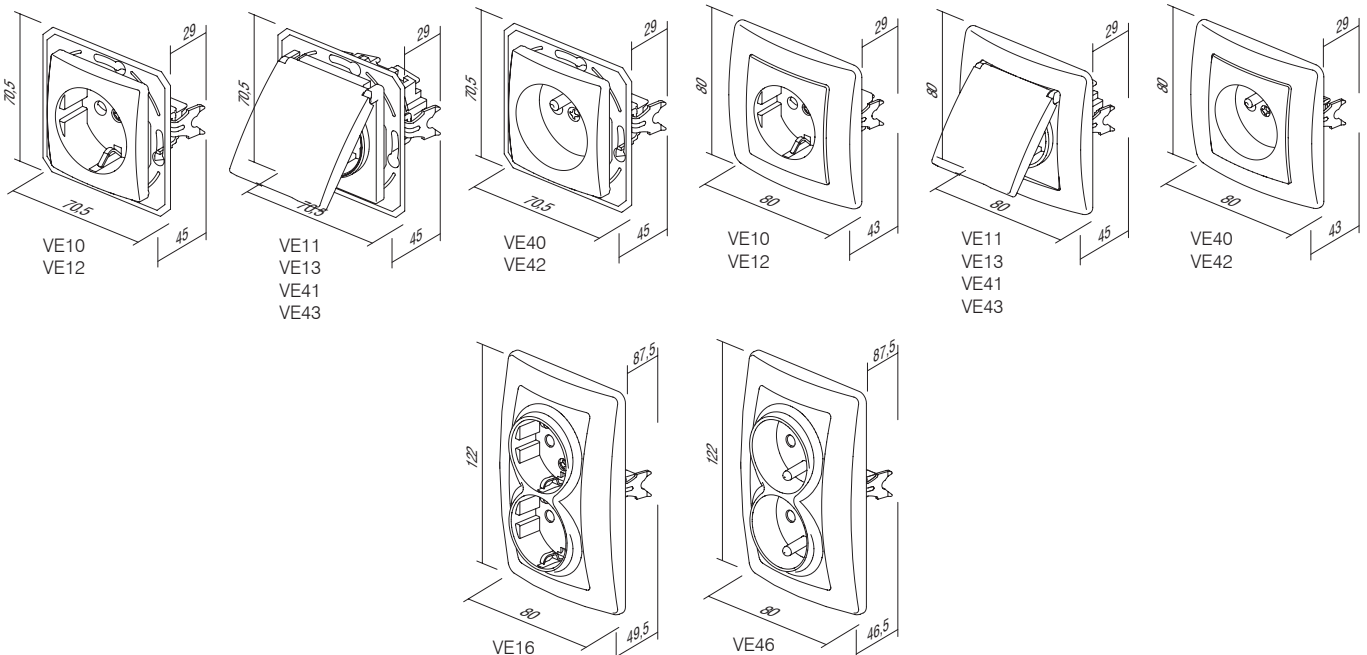

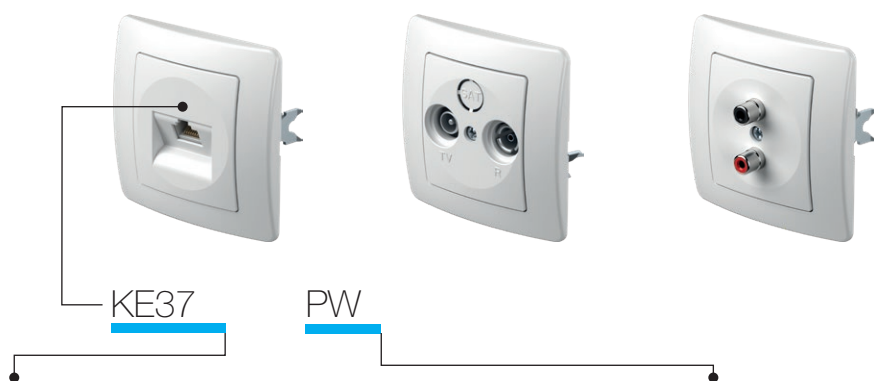

Iloji type	përshkrimi description	të dhënat teknike technical data	ngjyra colour
KE11	PRIZË TV-R ME KAPAK FUNDOR SOCKET TV-R END-LINE	1dB	<input type="checkbox"/> PW e bardhë polare polar white
KE12	PRIZË TV-R KALUESE SOCKET TV-R THROUGHPASS	10dB	<input type="checkbox"/> IW e bardhë fildishi ivory white
KE16	PRIZË SAT-TV-R ME KAPAK FUNDOR SOCKET SAT-TV-R END-LINE	3dB	<input type="checkbox"/> ES e argjendtë elox elox silver
⋮	⋮	⋮	<input type="checkbox"/> CO termoset i bardhë white thermoset
⋮	⋮	⋮	<input type="checkbox"/> NB e zezë mesnate night black

PRIZË TV-R ME KAPAK FUNDOR 1dB

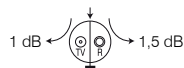

KE11

- TV-R me kapak fundor
- gama e frekuencës 5÷862MHz
- reduktimi: R-1.5dB, TV-1dB
- në përputhje me EN 50083-1
- kontaktet e vidave

SOCKET TV-R END-LINE 1dB

- TV-R end-line
- frequency range 5÷862MHz
- reduction: R-1.5dB, TV-1dB
- in accordance with EN 50083-1
- screw contacts

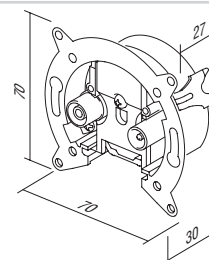

PRIZË TV-R KALUESE 10dB

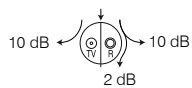

KE12

- TV-R kaluese
- gama e frekuencës 5÷862MHz
- reduktimi: R-10dB, TV-10dB, kaluese-2dB
- në përputhje me EN 50083-1
- kontaktet e vidave

SOCKET TV-R TROUGHPASS 10dB

- TV-R troughpass
- frequency range 5÷862MHz
- reduction: R-10dB, TV-10dB, trough-2dB
- in accordance with EN 50083-1
- screw contacts

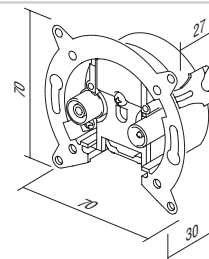

PRIZË SAT-TV-R ME KAPAK FUNDOR 3dB

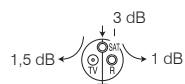

KE16

- SAT-TV-R me kapak fundor
- gama e frekuencës 5÷2400MHz
- reduktimi: R-1dB, TV-1.5dB, SAT-3dB
- për montim në kuti të rrumbullakët Ø60 me kthetra ose vida
- në përputhje me EN 50083-1
- kontaktet e vidave

SOCKET SAT-TV-R END-LINE 3dB

- SAT-TV-R end-line
- frequency range 5÷2400MHz
- reduction: R-1dB, TV-1.5dB, SAT-3dB
- for mounting in round box Ø60 with claws or screws
- in accordance with EN 50083-1
- screw contacts

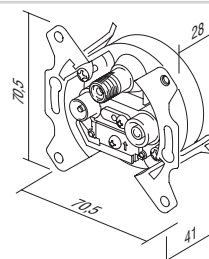

PRIZË TEL KS RJ11 6/4



KE36

- standard fiksues trapez KS
- RJ11 6/4
- në përputhje me IEC 60603-7

SOCKET TEL KS RJ11 6/4

- KS keystone fixing standard
- RJ11 6/4
- in accordance with IEC 60603-7

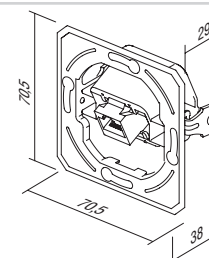



KE37

PRIZË CAT5e KS RJ45 8/8

- standard fiksues trapez KS
- CAT5e, RJ45 8/8
- në përputhje me IEC 60603-7

SOCKET CAT5e KS RJ45 8/8

- KS keystone fixing standard
- CAT5e, RJ45 8/8
- in accordance with IEC 60603-7

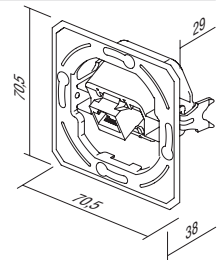

KE40

PRIZË CAT6s KS RJ45 8/8 SLIM

- standard fiksues trapez KS
- CAT6s, RJ45 8/8
- në përputhje me IEC 60603-7

SOCKET CAT6s KS RJ45 8/8 SLIM

- KS keystone fixing standard
- CAT6s, RJ45 8/8
- in accordance with IEC 60603-7

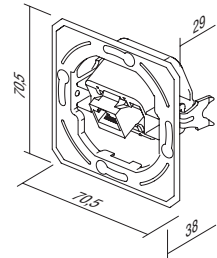

KE38

PRIZË TEL KS DYSHE 2x RJ11 6/4

- standard fiksues trapez KS
- 2x RJ11 6/4
- në përputhje me IEC 60603-7

SOCKET TEL KS DOUBLE 2x RJ11 6/4

- KS keystone fixing standard
- 2x RJ11 6/4
- in accordance with IEC 60603-7

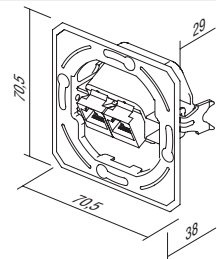

KE39

PRIZË CAT5e KS DYSHE 2x RJ45 8/8

- standard fiksues trapez KS
- 2x CAT5e, RJ45 8/8
- në përputhje me IEC 60603-7

SOCKET CAT5e KS DOUBLE 2x RJ45 8/8

- KS keystone fixing standard
- 2x CAT5e, RJ45 8/8
- in accordance with IEC 60603-7

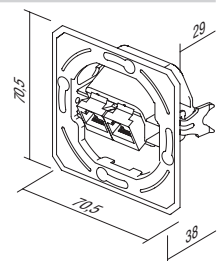

KE41

PRIZË CAT6s KS DYSHE 2x RJ45 8/8 SLIM

- standard fiksues trapez KS
- 2x CAT6s, RJ45 8/8
- në përputhje me IEC 60603-7

SOCKET CAT6s KS DOUBLE 2x RJ45 8/8 SLIM

- KS keystone fixing standard
- 2x CAT6s, RJ45 8/8
- in accordance with IEC 60603-7

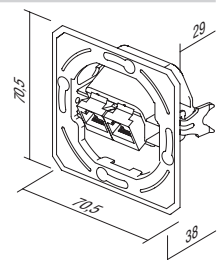

KE45

PËRSHTATËS KS NJËSH

- standard fiksues trapez KS - njësh
- AMP, Avaya, Brandrex, FMT, Mfico, Tyco, ...
- moduli i komunikimit nuk përfshihet

ADAPTER KS SINGLE

- KS keystone fixing standard - single
- AMP, Avaya, Brandrex, FMT, Mfico, Tyco, ...
- communication module not included

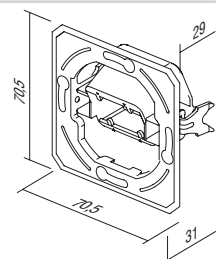



KE46

PËRSHTATËS KS DYSH

- standard fiksues trapez KS - dysh
- AMP, Tyco, ...
- moduli i komunikimit nuk përfshihet

ADAPTER KS DOUBLE

- KS keystone fixing standard - double
- AMP, Tyco, ...
- communication module not included

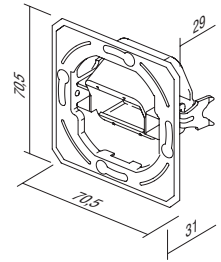

KE47

PËRSHTATËS PD DYSH

- standard fiksues PD Panduit Mini-COM - dysh
- moduli i komunikimit nuk përfshihet

ADAPTER PD DOUBLE

- PD Panduit Mini-COM fixing standard - double
- communication module not included

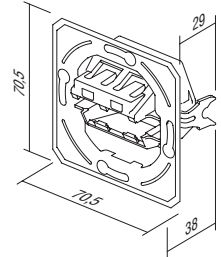

PRIZË TV BAZË 0dB



- KE10PW
- KE10IW
- KE10ES
- KE10CO
- KE10NB

- TV bazë
- reduktim 0dB
- lidhje e pasme – F standarde

SOCKET TV BASIC 0dB

- TV basic
- reduction 0dB
- back connector – F standard



PRIZË TV-R ME KAPAK FUNDOR 1dB



- KE11PW
- KE11IW
- KE11ES
- KE11CO
- KE11NB

- TV-R me kapak fundor
- gama e frekuencës 5÷862 MHz
- reduktimi: R-1.5dB, TV-1dB
- në përputhje me EN 50083-1
- kontaktet e vidave

SOCKET TV-R END-LINE 1dB

- TV-R end-line
- frequency range 5÷862 MHz
- reduction: R-1.5dB, TV-1dB
- in accordance with EN 50083-1
- screw contact



PRIZË TV-R KALUESE 10dB



- KE12PW
- KE12IW
- KE12ES
- KE12CO
- KE12NB

- TV-R kaluese
- gama e frekuencës 5÷862 MHz
- reduktimi: R-10dB, TV-10dB, kaluese-2dB
- në përputhje me EN 50083-1
- kontaktet e vidave

SOCKET TV-R TROUGH-PASS 10dB

- TV-R troughpass
- frequency range 5÷862 MHz
- reduction: R-10dB, TV-10dB, trough-2dB
- in accordance with EN 50083-1
- screw contacts



PRIZË SAT-TV-R ME KAPAK FUNDOR 3dB



- KE16PW
- KE16IW
- KE16ES
- KE16CO
- KE16NB

- SAT-TV-R me kapak fundor
- gama e frekuencës 5÷2400 MHz
- reduktimi: R-1dB, TV-1.5dB, SAT-3dB
- në përputhje me EN 50083-1
- kontaktet e vidave

SOCKET SAT-TV-R END-LINE 3dB

- SAT-TV-R end-line
- frequency range 5÷2400 MHz
- reduction: R-1dB, TV-1.5dB, SAT-3dB
- in accordance with EN 50083-1
- screw contacts



PRIZË AUDIO 2xRCA



- KE22PW
- KE22IW
- KE22ES
- KE22CO
- KE22NB

- audio 2xRCA
- lidhje me saldime e kablos

SOCKET AUDIO 2xRCA

- audio 2xRCA
- soldering connection of cable



PRIZË AUDIO ALTOPARLANTË



- KE23PW
- KE23IW
- KE23ES
- KE23CO
- KE23NB

- audio 2x Ø4mm
- për të mbajtur telin e altoparlantit, spinë banane Ø4 mm ose maç
- lidhje me ngjitje e kablos në pjesën e pasme

SOCKET AUDIO LOUDSPEAKERS

- audio 2x Ø4mm
- to accommodate speaker wire, banana plug Ø4mm or spades
- soldering connection of cable at the back side



PRIZË TEL KS RJ11 6/4

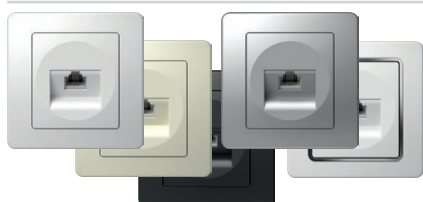

- KE36PW
- KE36IW
- KE36ES
- KE36CO
- KE36NB

- standard fiksues trapez KS
- RJ11 6/4
- në përputhje me IEC 60603-7

SOCKET TEL KS RJ11 6/4

- KS keystone fixing standard
- RJ11 6/4
- in accordance with IEC 60603-7





- KE37PW
- KE37IW
- KE37ES
- KE37CO
- KE37NB

PRIZË CAT5e KS RJ45 8/8

- standard fiksues trapez KS
- CAT5e, RJ45 8/8
- në përputhje me IEC 60603-7

SOCKET CAT5e KS RJ45 8/8

- KS keystone fixing standard
- CAT5e, RJ45 8/8
- in accordance with IEC 60603-7

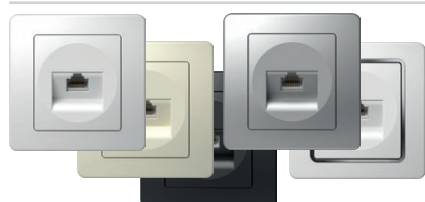

- KE40PW
- KE40IW
- KE40ES
- KE40CO
- KE40NB

PRIZË CAT6s KS RJ45 8/8 SLIM

- standard fiksues trapez KS
- CAT6s, RJ45 8/8
- në përputhje me IEC 60603-7

SOCKET CAT6s KS RJ45 8/8 SLIM

- KS keystone fixing standard
- CAT6s, RJ45 8/8
- in accordance with IEC 60603-7

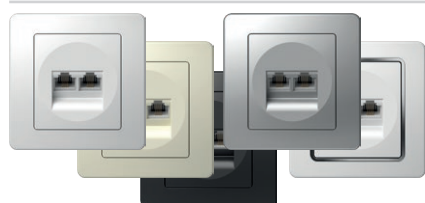

- KE38PW
- KE38IW
- KE38ES
- KE38CO
- KE38NB

PRIZË TEL KS DYSHE 2x RJ11 6/4

- standard fiksues trapez KS
- 2x RJ11, 6/4
- në përputhje me IEC 60603-7

SOCKET TEL KS DOUBLE 2x RJ11 6/4

- KS keystone fixing standard
- 2x RJ11, 6/4
- in accordance with IEC 60603-7



- KE39PW
- KE39IW
- KE39ES
- KE39CO
- KE39NB

PRIZË CAT5e KS DYSHE 2x RJ45 8/8

- standard fiksues trapez KS
- 2x CAT5e, RJ45 8/8
- në përputhje me IEC 60603-7

SOCKET CAT5e KS DOUBLE 2x RJ45 8/8

- KS keystone fixing standard
- 2x CAT5e, RJ45 8/8
- in accordance with IEC 60603-7



- KE41PW
- KE41IW
- KE41ES
- KE41CO
- KE41NB

PRIZË CAT6s KS DYSHE 2x RJ45 8/8 SLIM

- standard fiksues trapez KS
- 2x CAT6s, RJ45 8/8
- në përputhje me IEC 60603-7

SOCKET CAT6s KS DOUBLE 2x RJ45 8/8 SLIM

- KS keystone fixing standard
- 2x CAT6s, RJ45 8/8
- in accordance with IEC 60603-7

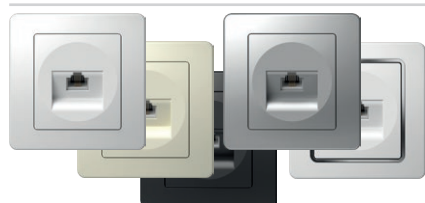

- KE35PW
- KE35IW
- KE35ES
- KE35CO
- KE35NB

PRIZË TEL LT RJ11 6/4

- vidë TEL LT
- kontaktet e vidave
- RJ11 6/4
- në përputhje me IEC 60603-7

SOCKET TEL LT RJ11 6/4

- TEL LT screw
- screw contacts
- RJ11 6/4
- in accordance with IEC 60603-7

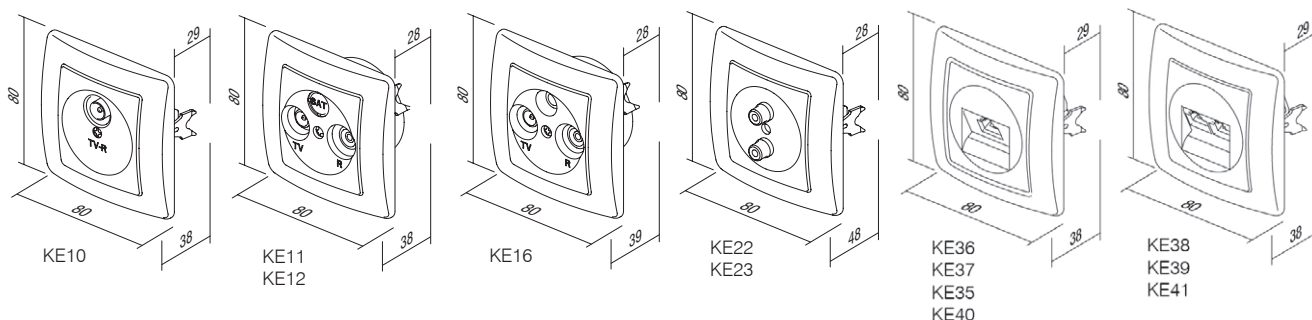

K A P A K P Ë R K O M U N I K I M E T K E

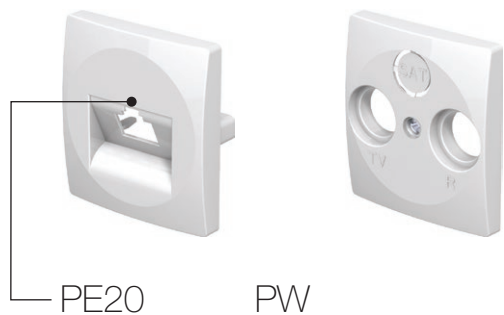

lloji type	përshkrimi description	të dhënat teknike technical data	ngjyra colour
PE10	KAPAK TV-R COVER TV-R	2P/3P	<input type="checkbox"/> PW e bardhë polare polar white
PE20	KAPAK KS NJËSH COVER KS SINGLE		<input type="checkbox"/> IW e bardhë fildishi ivory white
PE21	KAPAK KS DYSH COVER KS DOUBLE		<input type="checkbox"/> ES e argjendtë elox elox silver
⋮	⋮	⋮	<input type="checkbox"/> CO termoset i bardhë white thermoset
			<input type="checkbox"/> NB e zezë mesnate night black

KAPAK TV-R 2P/3P

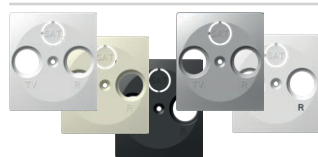

- PE10PW
- PE10IW
- PE10ES
- PE10CO
- PE10NB

- kapak TV-R, 2P ose 3P me vidë
COVER TV-R 2P/3P
- TV-R cover, 2P or 3P with screw



KAPAK KS NJËSH

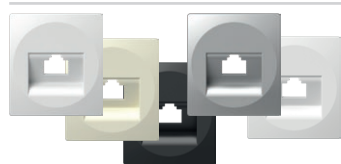

- PE20PW
- PE20IW
- PE20ES
- PE20CO
- PE20NB

- kapak KS njësh
COVER KS SINGLE
- KS cover single



KAPAK KS DYSH

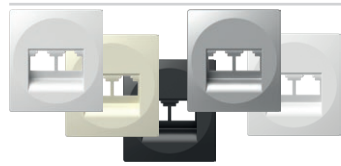

- PE21PW
- PE21IW
- PE21ES
- PE21NB

- kapak KS dysh
COVER KS DOUBLE
- KS cover double



KAPAK TAE/TDO



- PE30PW
- PE30IW
- PE30ES
- PE30NB

- kapak TAE ose TDO me vidë
COVER TAE/TDO
- TAE or TDO cover with screw



KAPAK ÇELËS IR



- PE32PW
- PE32IW
- PE32ES
- PE32NB

- kapak çelës IR
COVER IR SWITCH
- cover IR switch

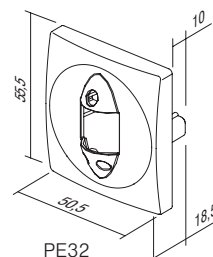
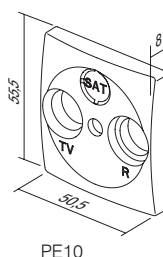
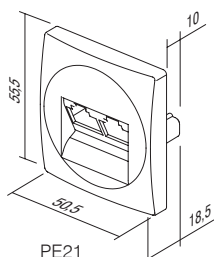
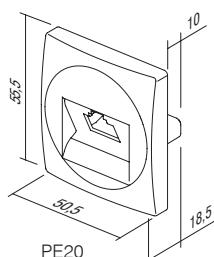
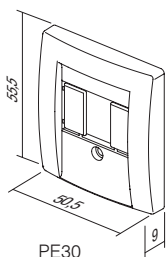

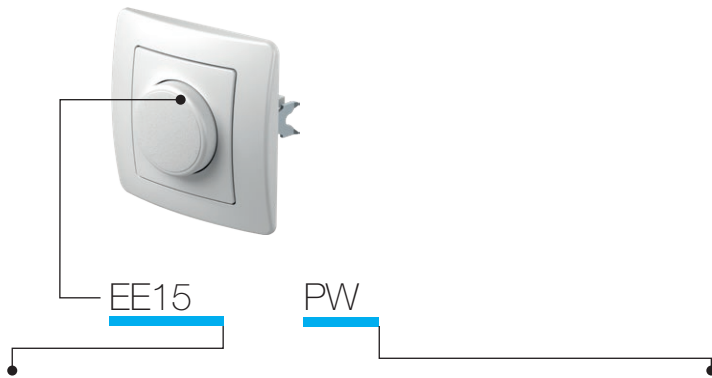

Iloji type	përshkrimi description	të dhënat teknike technical data	ngjyra colour
EE15	REOSTAT RROTULLUES ME 2 DREJTIME DIMMER ROTATIVE 2WAY	RL 400W	<input type="checkbox"/> PW e bardhë polare polar white
EE16	REOSTAT RROTULLUES ME 2 DREJTIME DIMMER ROTATIVE 2WAY	RLC 400W	<input type="checkbox"/> IW e bardhë fildishi ivory white
EE19	REOSTAT RROTULLUES ME 2 DREJTIME DIMMER ROTATIVE 2WAY	LED 100W	<input type="checkbox"/> ES e argjendtë elox elox silver
⋮	⋮	⋮	<input type="checkbox"/> CO termoset i bardhë white thermoset
⋮	⋮	⋮	<input type="checkbox"/> NB e zezë mesnate night black

REOSTAT RROTULLUES ME 2 DREJTIME RL 400 W



EE15

- kontroll i rrotullimit me çelësin me 2 drejtime
- RL i ngarkesës, 40 W - 400W
- është i mundur kombinimi i çelësit me 2 drejtime
- nuk lejohet kombinim i më shumë reostateve
- në përputhje me standardet EN 60669-1 dhe EN 60669-2-1
- kontakte për futje telash 1,5 mm²
- tensioni i furnizimit, 230 V ~ 50 Hz
- diametri i brendshëm i butonit Ø6 mm
- përfshihet siguresa e zëvendësueshme

DIMMER ROTATIVE 2WAY RL 400W

- rotation control with 2-way switch
- load RL, 40W - 400W
- 2-way switch combination is possible
- more dimmers combination is not allowed
- in accordance with EN 60669-1 and EN 60669-2-1
- plug-in contacts 1.5mm²
- supply 230V ~ 50Hz
- button inner diameter Ø6mm
- replaceable fuse included

REOSTAT RROTULLUES ME 2 DREJTIME RLC 400 W



EE16

- kontroll i rrotullimit me çelësin me 2 drejtime
- RLC i ngarkesës, 20W - 400W
- është i mundur kombinimi i çelësit me 2 drejtime
- nuk lejohet kombinim i më shumë reostateve
- në përputhje me standardet EN 60669-1 dhe EN 60669-2-1
- kontakte për futje telash 1,5 mm²
- tensioni i furnizimit, 230 V ~ 50 Hz
- diametri i brendshëm i butonit Ø6 mm
- siguresë elektronike

DIMMER ROTATIVE 2WAY RLC 400W

- rotation control with 2-way switch
- load RLC, 20W - 400W
- 2-way switch combination is possible
- more dimmers combination is not allowed
- in accordance with EN 60669-1 and EN 60669-2-1
- plug-in contacts 1.5mm²
- supply 230V ~ 50Hz
- button inner diameter Ø6mm
- electronic fuse



EE19

REOSTAT RROTULLUES ME 2 DREJTIME LED 100W

- kontroll i rrotullimit me çelësin me 2 drejtime
- ngarkesa: LED, 0-100 W (maks. 10 LED-e)
GLS, 10-250 W
- është i mundur kombinimi i çelësit me 2 drejtime
- nuk lejohet kombinim i më shumë reostateve
- në përputhje me standardet EN 60669-1 dhe EN 60669-2-1
- kontakte për futje telash 1,5 mm²
- tensioni i furnizimit, 230 V[~] 50 Hz
- përfshihet siguresa e zëvendësueshme
- diametri i brendshëm i butonit Ø6 mm

DIMMER ROTATIVE 2WAY LED 100W

- rotation control with 2-way switch
- load: LED, 0-100W (max. 10 LEDs)
GLS, 10-250W
- 2-way switch combination is possible
- more dimmers combination is not allowed
- in accordance with EN 60669-1 and EN 60669-2-1
- plug-in contacts 1.5mm²
- supply 230V[~] 50Hz
- replaceable fuse included
- button inner diameter Ø6mm

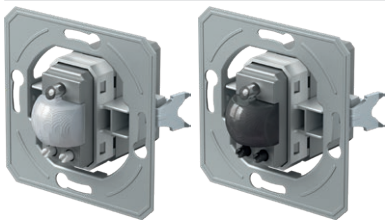

- EE32A1
- EE32A2

ÇELËS IR 5A X 250V~

- çelës IR me infra të kuqe
- furnizimi me energji: 230 V[~] ±10 % 50 Hz
- rele: 5 A / 250 V[~] dalja për rrymën e kufizuar me rezistencë të lartë për kryqëzim zero
- vlerësimi i mbrojtjes: IP40
- prerja e tërthortë e telave në kontakt 0,75 - 2,5 mm²
- zona e zbulimit: deri në 110° në 20°C
- zona e zbulimit: rreth 8 m në 20°C
- rregullimi i kohëzgjatjes: nga rreth 5 sek. në 12 min.
- rregullimi i ndriçimit: nga rreth 5 deri 200 LUX
- temperatura e funksionimit: nga 0°C në +40°C
- i papërshtatshëm për instalim në kuti me thellësi 45 mm
- vetëm për përdorim të brendshëm

IR SWITCH 5A 230V~

- IR infrared switch
- supply voltage: 230V[~] ±10 % 50Hz
- relay: 5A / 250V[~] output for limited current with high resistance for zero crossing
- protection rating: IP40
- cross-section of wires at the contact terminal: 0.75 - 2.5 mm²
- detection angle: up to 110° at 20°C
- detection area: approx. 8 m at 20°C
- adjustability of duration: from approx. 5 s to 12 min
- adjustability of brightness: from approx. 5 to 200 LUX
- operating temperature: from 0°C to +40°C
- not suitable for installation in 45 mm deep boxes
- only for indoor usage



- EE15PW
- EE15IW
- EE15ES
- EE15CO
- EE15NB

REOSTAT RROTULLUES ME 2 DREJTIME RL 400 W

- kontroll i rrotullimit me çelësin me 2 drejtime
- RL i ngarkesës, 40 W - 400W
- është i mundur kombinimi i çelësit me 2 drejtime
- nuk lejohet kombinim i më shumë reostateve
- në përputhje me standardet EN 60669-1 dhe EN 60669-2-1
- kontakte për futje telash 1,5 mm²
- tensioni i furnizimit, 230 V[~] 50 Hz
- përfshihet siguresa e zëvendësueshme

DIMMER ROTATIVE 2WAY RL 400W

- rotation control with 2-way switch
- load RL, 40W - 400W
- 2-way switch combination is possible
- more dimmers combination is not allowed
- in accordance with EN 60669-1 and EN 60669-2-1
- plug-in contacts 1.5mm²
- supply 230V[~] 50Hz
- replaceable fuse included



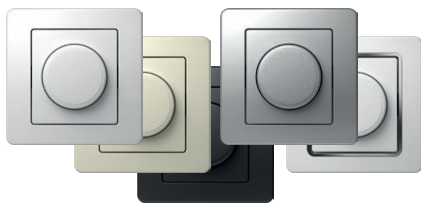

- EE16PW
- EE16IW
- EE16ES
- EE16CO
- EE16NB

REOSTAT RROTULLUES ME 2 DREJTIME RLC 400 W

- kontroll i rrotullimit me çelësin me 2 drejtime
- RLC i ngarkesës, 20W - 400W
- është i mundur kombinimi i çelësit me 2 drejtime
- nuk lejohet kombinimi i më shumë reostateve
- në përputhje me standardet EN 60669-1 dhe EN 60669-2-1
- kontakte për futje telash 1,5 mm²
- tensioni i furnizimit, 230 V ~ 50 Hz
- siguresë elektronike



DIMMER ROTATIVE 2WAY RLC 400W

- rotation control with 2-way switch
- load RLC, 20W - 400W
- 2-way switch combination is possible
- more dimmers combination is not allowed
- in accordance with EN 60669-1 and EN 60669-2-1
- plug-in contacts 1.5mm²
- supply 230V ~ 50Hz
- electronic fuse



- EE19PW
- EE19IW
- EE19ES
- EE19CO
- EE19NB

REOSTAT RROTULLUES ME 2 DREJTIME LED 100W

- kontroll i rrotullimit me çelësin me 2 drejtime
- ngarkesa: LED, 0-100 W (maks. 10 LED-e)
- GLS, 10-250 W
- është i mundur kombinimi i çelësit me 2 drejtime
- nuk lejohet kombinimi i më shumë reostateve
- në përputhje me standardet EN 60669-1 dhe EN 60669-2-1
- kontakte për futje telash 1,5 mm²
- tensioni i furnizimit, 230 V ~ 50 Hz
- përfshihet siguresa e zëvendësueshme



DIMMER ROTATIVE 2WAY LED 100W

- rotation control with 2-way switch
- load: LED, 0-100W (max. 10 LEDs)
- GLS, 10-250W
- 2-way switch combination is possible
- more dimmers combination is not allowed
- in accordance with EN 60669-1 and EN 60669-2-1
- plug-in contacts 1.5mm²
- supply 230V ~ 50Hz
- replaceable fuse included



- EE32PW
- EE32IW
- EE32ES
- EE32CO
- EE32NB

ÇELËS IR 5A X 230V~

- çelës IR me infra të kuqe
- furnizimi me energji: 230 V ~ ±10 % 50 Hz
- rele: 5 A / 250 V ~ dalja për rrymën e kufizuar me rezistencë të lartë për kryqëzim zero
- vlerësimi i mbrojtjes: IP40
- prerja e tërthortë e telave në kontakt 0,75 - 2,5 mm²
- zona e zbulimit: deri në 110° në 20°C
- zona e zbulimit: rreth 8 m në 20°C
- rregullimi i kohëzgjatjes: nga rreth 5 sek. në 12 min.
- rregullimi i ndriçimit: nga rreth 5 deri 200 LUX
- temperatura e funksionimit: nga 0°C në +40°C
- i papërshtatshëm për instalim në kuti me thellësi 45 mm
- vetëm për përdorim të brendshëm



IR SWITCH 5A 230V~

- IR infrared switch
- supply voltage: 230V ~ ±10 % 50Hz
- relay: 5A / 250V ~ output for limited current with high resistance for zero crossing
- protection rating: IP40
- cross-section of wires at the contact terminal: 0.75 - 2.5 mm²
- detection angle: up to 110° at 20°C
- detection area: approx. 8 m at 20°C
- adjustability of duration: from approx. 5 s to 12 min
- adjustability of brightness: from approx. 5 to 200 LUX
- operating temperature: from 0°C to +40°C
- not suitable for installation in 45 mm deep boxes
- only for indoor usage

EE15, EE16, EE19

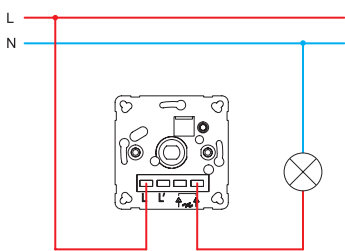

EE15, EE16, EE19

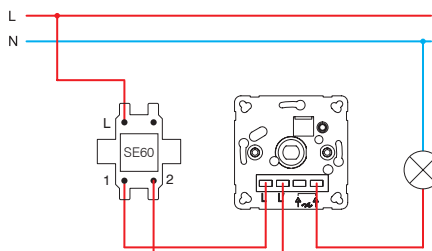

EE15, EE16, EE19

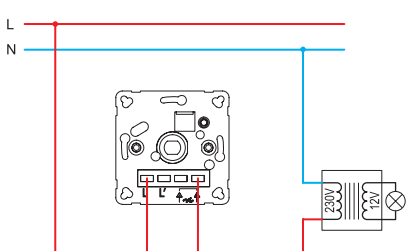

EE15, EE16, EE19

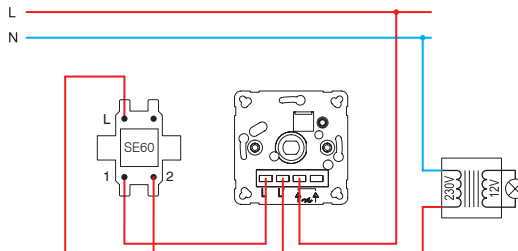

EE16, EE19

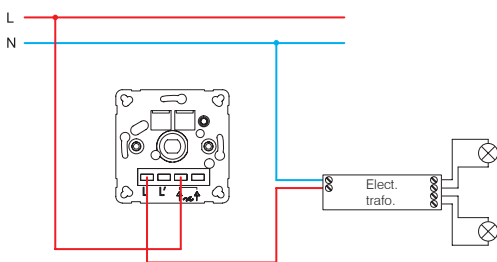

EE16, EE19

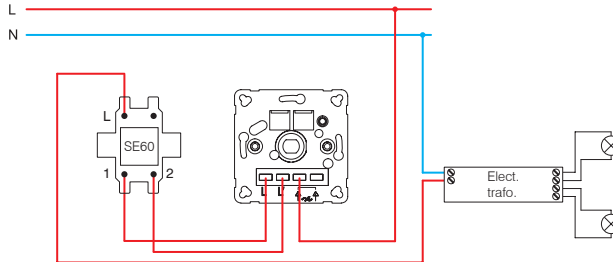

EE15 (40÷400W)

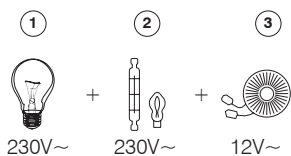

- 1 - llambë inkandeshente / incandescent lamp
- 2 - llambë halogjene / halogen lamp

EE16 (20÷400W)

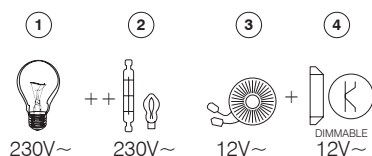

- 3 - transformator klasik / classical transformer
- 4 - transformator elektrik me dimer / dimmable electronic transformer

EE19 (GLS 10÷250W ; LED 0÷100W)

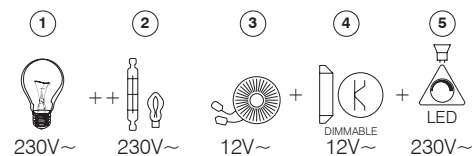

- 5 - llambë LED me ulje ndriçimi / dimmable LED lamp

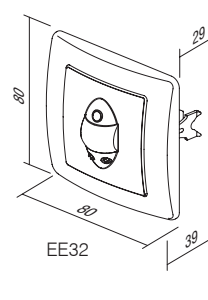
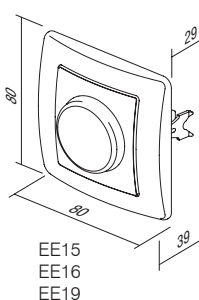
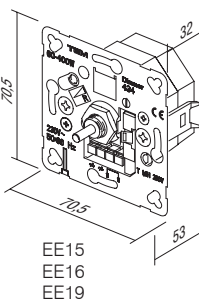

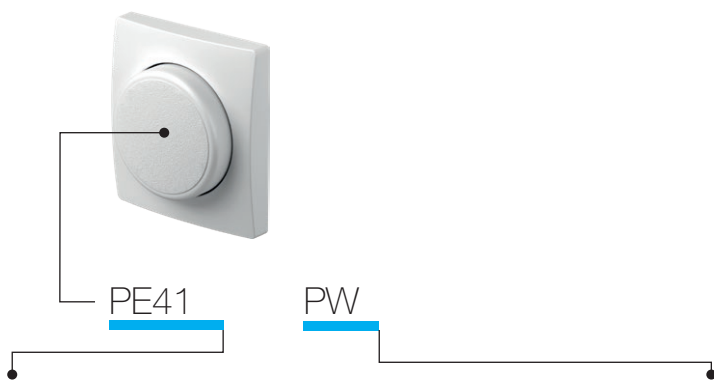

lloji type	përshkrimi description	ngjyra colour
PE41	REOSTAT ME KAPAK COVER DIMMER	<input type="checkbox"/> PW e bardhë polare <i>polar white</i> <input type="checkbox"/> IW e bardhë fildishi <i>ivory white</i> <input type="checkbox"/> ES e argjendtë elox <i>elox silver</i> <input type="checkbox"/> CO termoset i bardhë <i>white thermoset</i> <input type="checkbox"/> NB e zezë mesnate <i>night black</i>



- PE41PW
- PE41IW
- PE41ES
- PE41CO
- PE41NB

REOSTAT ME KAPAK Ø6

- reostat me kapak Ø6 mm
- me EE15, EE16, EE19

COVER DIMMER Ø6
- cover dimmer Ø6mm
- for EE15, EE16, EE19

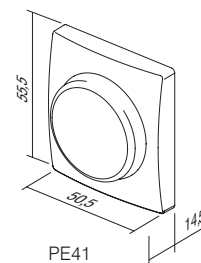

PE41

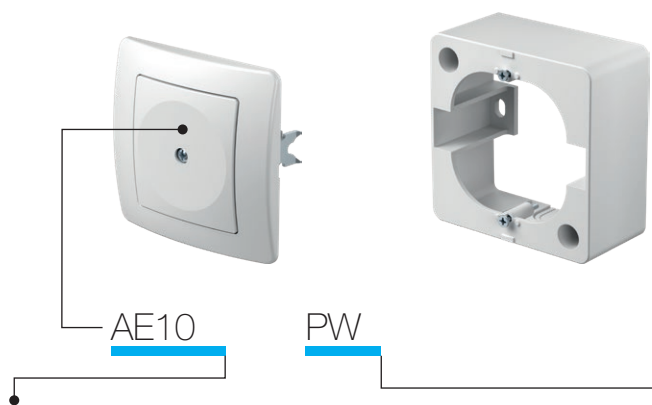

Iloji type	përshkrimi description	ngjyra colour
AE10	FALSO BLANK	<input type="checkbox"/> PW e bardhë polare polar white
AE20	KUTI LIDHJEJE 3P+N+E 5X4 mm ² CONNECTION BOX 3P+N+E 5X4mm ²	<input type="checkbox"/> IW e bardhë fildishi ivory white
AE30	KUTI ME MONTIM NË SIPËRFAQE NO 1 SURFACE MOUNT BOX	<input type="checkbox"/> ES e argjendtë elox elox silver
⋮	⋮	<input type="checkbox"/> CO termoset i bardhë white thermoset
⋮	⋮	<input type="checkbox"/> NB e zezë mesnate night black

FALSO



- AE10PW
- AE10IW
- AE10ES
- AE10CO
- AE10NB

- për mbushjen e hapësirave boshe
BLANK
- for filling up empty spaces



KUTI LIDHJEJE 5 POLARE 3P+N+E 5X4 mm²



- AE20PW
- AE20IW

- kuti lidhjeje 3P+N+E
- 16 A 400V[~]
- në përputhje me VDE 0606-1:2000
- kontaktet e vidave 1,5-4mm²

CONNECTION BOX 5POLE 3P+N+E 5x4mm²
- 3P+N+E connection box
- 16A 400V[~]
- in accordance with VDE 0606-1:2000
- screw contacts 1.5-4mm²



KUTI ME MONTIM NË SIPËRFAQE 1

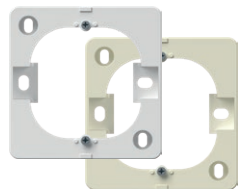

- AE30PW
- AE30IW

- kuti me montim në sipërfaqe
SURFACE MOUNT BOX 1
- surface mounting box



KUTI SIPËRFAQËSORE PËR PRIZË DYSHE EKONOMIK

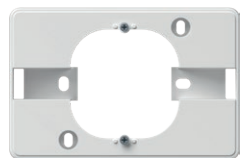

- AE31PW

- kuti me montim në sipërfaqe
SURFACE MOUNT BOX FOR EKONOMIK DOUBLE SOCKET
- surface mounting box



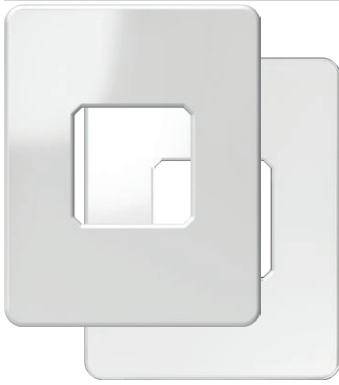

- AE50PW
- AE50TS

MBROJTJE PËR MUR

- mbron sipërfaqen rrotull prizës ose çelësit

WALL PROTECTION

- protects surface around socket or switch

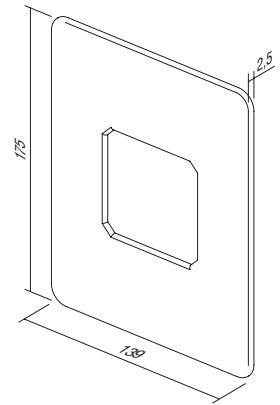

- AE51PW
- AE51IW

MBROJTJE PËR FËMIJËT KS

- insert shtesë KS për mbrojtje për fëmijët

CHILD PROTECTION KS

- KS additional child protection insert - shuttered live contacts

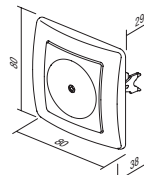
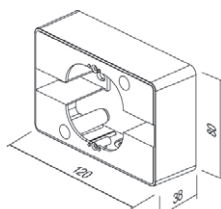
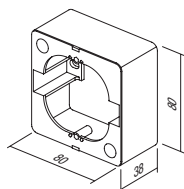
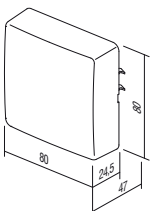
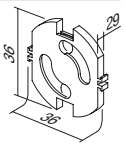

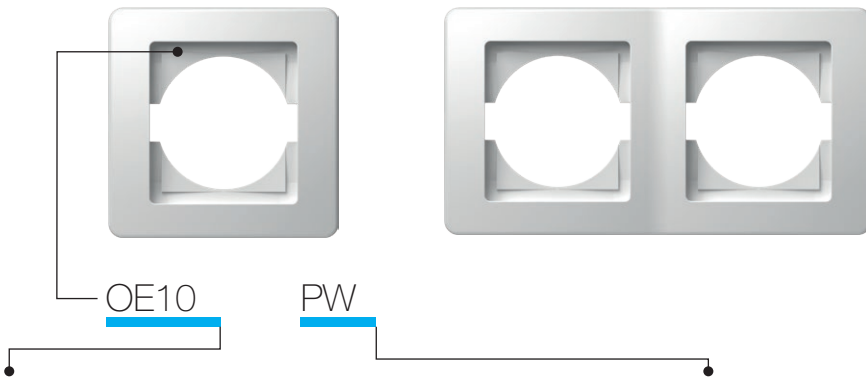

Iloji type	përshkrimi description	ngjyra colour
OE10	RRETHUES EKONOMIK 1 SURROUND EKONOMIK 1	<input type="checkbox"/> PW e bardhë polare polar white
OE20	RRETHUES EKONOMIK 2 HORIZONTAL SURROUND EKONOMIK 2 HORIZONTAL	<input type="checkbox"/> IW e bardhë fildishi ivory white
OE30	RRETHUES EKONOMIK 3 HORIZONTAL SURROUND EKONOMIK 3 HORIZONTAL	<input type="checkbox"/> ES e argjendtë elox elox silver
⋮	⋮	<input type="checkbox"/> CO termoset i bardhë white thermoset
⋮	⋮	<input type="checkbox"/> NB e zezë mesnate night black



- OE10PW
- OE10IW
- OE10ES
- OE10CO
- OE10NB

RRETHUES EKONOMIK 1

- rrethues dekorativ me 1 pozicion
- në përputhje me EN 60669-1

SURROUND EKONOMIK 1

- decorative surround 1-gang
- in accordance with EN 60669-1

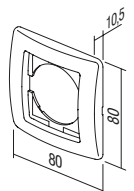

- OE20PW
- OE20IW
- OE20ES
- OE20CO
- OE20NB

RRETHUES EKONOMIK 2 HORIZONTAL

- rrethues dekorativ me 2 pozicione horizontal
- në përputhje me EN 60669-1

SURROUND EKONOMIK 2 HORIZONTAL

- decorative surround 2-gang horizontal
- in accordance with EN 60669-1

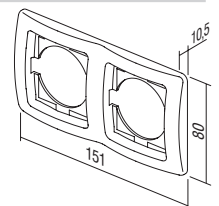

- OE21PW
- OE21IW
- OE21ES
- OE21CO
- OE21NB

RRETHUES EKONOMIK 2 VERTIKAL

- rrethues dekorativ me 2 pozicione vertikal
- në përputhje me EN 60669-1

SURROUND EKONOMIK 2 VERTIKAL

- decorative surround 2-gang vertical
- in accordance with EN 60669-1

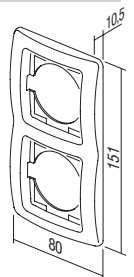

- OE30PW
- OE30IW
- OE30ES
- OE30CO
- OE30NB

RRETHUES EKONOMIK 3 HORIZONTAL

- rrethues dekorativ me 3 pozicione horizontal
- në përputhje me EN 60669-1

SURROUND EKONOMIK 3 HORIZONTAL

- decorative surround 3-gang horizontal
- in accordance with EN 60669-1

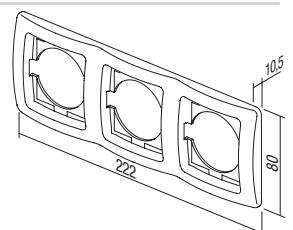



- OE31PW
- OE31IW
- OE31ES
- OE31CO
- OE31NB

RRETHUES EKONOMIK 3 VERTIKAL

- rrethues dekorativ me 3 pozicione vertikale
- në përputhje me EN 60669-1

SURROUND EKONOMIK 3 VERTIKAL

- decorative surround 3-gang vertical
- in accordance with EN 60669-1

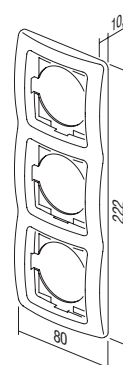

- OE40PW
- OE40IW
- OE40ES
- OE40NB

RRETHUES EKONOMIK 4 HORIZONTAL

- rrethues dekorativ me 4 pozicione horizontale
- në përputhje me EN 60669-1

SURROUND EKONOMIK 4 HORIZONTAL

- decorative surround 4-gang horizontal
- in accordance with EN 60669-1

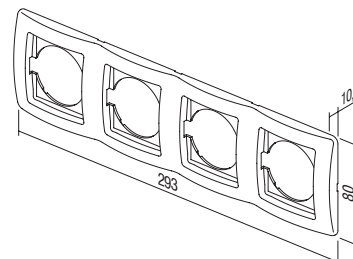

- OE41PW
- OE41IW
- OE41ES
- OE41NB

RRETHUES EKONOMIK 4 VERTIKAL

- rrethues dekorativ me 4 pozicione vertikale
- në përputhje me EN 60669-1

SURROUND EKONOMIK 4 VERTIKAL

- decorative surround 4-gang vertical
- in accordance with EN 60669-1

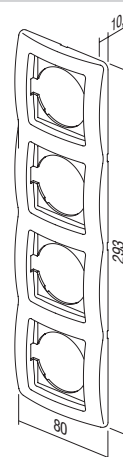

- OE50PW
- OE50IW
- OE50ES
- OE50NB

RRETHUES EKONOMIK 5 HORIZONTAL

- rrethues dekorativ me 5 pozicione horizontale
- në përputhje me EN 60669-1

SURROUND EKONOMIK 5 HORIZONTAL

- decorative surround 5-gang horizontal
- in accordance with EN 60669-1

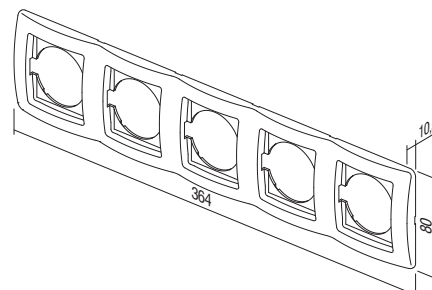

KORNIZA DEKORATIVE ME NGJYRA /
COLOR DECORATIVE FRAMES

OE90GR	E GJELBËR / <i>GREEN</i>	OE90YL	E VERDHË / <i>YELLOW</i>	OE90MB	MET. BLU / <i>MET. BLUE</i>
OE90BL	BLU / <i>BLUE</i>	OE90WH	E BARDHË / <i>WHITE</i>	OE90BZ	BRONZ / <i>BRONZE</i>
OE90VO	VJOLLÇË / <i>VIOLET</i>	OE90GY	GRI / <i>GREY</i>	OE90CR	E ARGJENDTË / <i>SILVER</i>
OE90PI	ROZË / <i>PINK</i>	OE90BK	E ZEZË / <i>BLACK</i>	OE90GO	E ARTË / <i>GOLD</i>
OE90RD	E KUQE / <i>RED</i>				



TEM



KATALOGU / CATALOGUE

fontana



ÇELĒSAT SF
SWITCHES SF



218

PRIZAT VF
SOCKETS VF



220

SETI CF
SETS CF



221

AKSESORĒT AF
ACCESSORIES AF



223

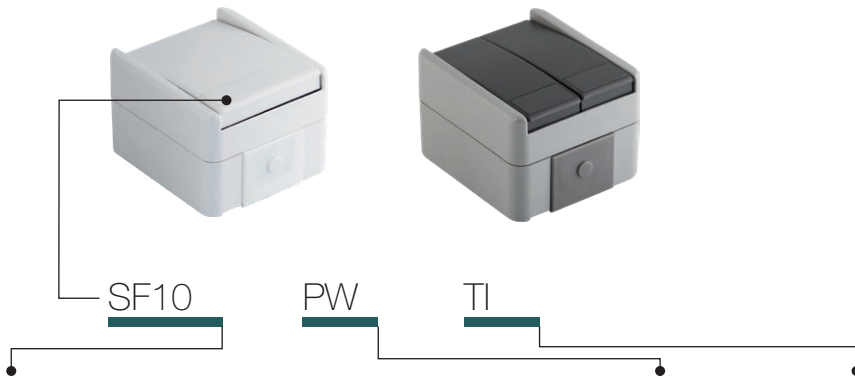

Iloji type	përshkrimi description	të dhënat teknike technical data	ngjyra colour	të dhënat opsionale 1 optional data 1
SF10	ÇELËS ME 1 DREJTIM SWITCH 1WAY	IP44 10AX 250V~	<input type="checkbox"/> PW e bardhë-mat white-mat	TI llambë neoni+tregues neon lamp+indication
SF11	BUTON MESHTYPJE ME 1 DREJTIM PUSH BUTTON 1WAY	IP44 10A 250V~	<input type="checkbox"/> GY gri-mat grey-mat	
SF20	ÇELËS 2 POLAR SWITCH 2POLE	IP44 10AX 250V~		
:	:	:		
:	:	:		

ÇELËS ME 1 DREJTIM IP44 10 A X 250 V~



SF10PW
 SF10GY

- 10 A X 250 V~, Iloji SF10
- në përputhje me EN 60669-1
- kontakte për futje telash 1,5-2,5 mm²

SWITCH 1WAY IP44 10AX 250V~

- 10AX 250V~, type SF10
- in accordance with EN 60669-1
- plug-in contacts 1.5-2.5mm²



ÇELËS ME 1 DREJTIM IP44 10 A X 250 V~ __ TI



SF10PWTI
 SF10GYTI

- TI tregues+llambë neoni
- 10 A X 250 V~, Iloji SF10
- në përputhje me EN 60669-1
- kontakte për futje telash 1,5-2,5 mm²

SWITCH 1WAY IP44 10AX 250V~ __ TI

- TI indicator+neon lamp
- 10AX 250V~, type SF10
- in accordance with EN 60669-1
- plug-in contacts 1.5-2.5mm²



BUTON ME SHTYPJE ME 1 DREJTIM IP44 10 A 250 V~ __ TI



SF11PWTI
 SF11GYTI

- TI tregues+llambë neoni
- 10A 250 V~, Iloji SF11
- në përputhje me EN 60669-1
- kontakte për futje telash 1,5-2,5 mm²

PUSH BUTTON 1WAY IP44 10A 250V~ __ TI

- TI indicator+neon lamp
- 10A 250V~, type SF11
- in accordance with EN 60669-1
- plug-in contacts 1.5-2.5mm²



ÇELËS ME 2 DREJTIME IP44 10 A X 250 V~



SF20PW
 SF20GY

- 10 A X 250 V~, Iloji SF20
- në përputhje me EN 60669-1
- kontakte për futje telash 1,5-2,5 mm²

SWITCH 2POLE IP44 10AX 250V~

- 10AX 250V~, type SF20
- in accordance with EN 60669-1
- plug-in contacts 1.5-2.5mm²



ÇELËS ME 2 POZICIONE 1 DREJTIM IP44 10 A X 250 V~

- SF50PW
- SF50GY

- 10 A X 250 V~, Iloji SF50
- në përputhje me EN 60669-1
- kontakte për futje telash 1,5-2,5 mm²

SWITCH 2GANG-1WAY IP44 10AX 250V~

- 10AX 250V~, type SF50
- in accordance with EN 60669-1
- plug-in contacts 1.5-2.5mm²

BUTON ME SHTYPJE ME 2 POZICIONE - 1 DREJTIM IP44 10A 250 V~

- SF51PW
- SF51GY

- 10A 250 V~, Iloji SF51
- në përputhje me EN 60669-1
- kontakte për futje telash 1,5-2,5 mm²

PUSH BUTTON 2GANG-1WAY IP44 10A 250V~

- 10A 250V~, type SF51
- in accordance with EN 60669-1
- plug-in contacts 1.5-2.5mm²

ÇELËS ME 2 DREJTIME IP44 10 A X 250 V~

- SF60PW
- SF60GY

- 10 A X 250 V~, Iloji SF60
- në përputhje me EN 60669-1
- kontakte për futje telash 1,5-2,5 mm²

SWITCH 2WAY IP44 10AX 250V~

- 10AX 250V~, type SF60
- in accordance with EN 60669-1
- plug-in contacts 1.5-2.5mm²

ÇELËS ME 2 DREJTIME IP44 10 A X 250 V~ __ TI

- SF60PWTI
- SF60GYTI

- TI tregues+llambë neoni
- 10 A X 250 V~, Iloji SF60
- në përputhje me EN 60669-1
- kontakte për futje telash 1,5-2,5 mm²

SWITCH 2WAY IP44 10AX 250V~ __ TI

- TI indicator+neon lamp
- 10AX 250V~, type SF60
- in accordance with EN 60669-1
- plug-in contacts 1.5-2.5mm²

ÇELËS ME 2 DREJTIME DYSH IP44 10 A X 250 V~

- SF63PW
- SF63GY

- 10 A X 250 V~, Iloji SF63
- në përputhje me EN 60669-1
- kontakte për futje telash 1,5-2,5 mm²

SWITCH 2WAY DOUBLE IP44 10AX 250V~

- 10AX 250V~, type SF63
- in accordance with EN 60669-1
- plug-in contacts 1.5-2.5mm²



ÇELËS NDËRMJETËS IP44 10 A X 250 V~

- SF70PW
- SF70GY

- 10 A X 250 V~, Iloji SF70
- në përputhje me EN 60669-1
- kontakte për futje telash 1,5-2,5 mm²

SWITCH INTERMEDIATE IP44 10AX 250V~

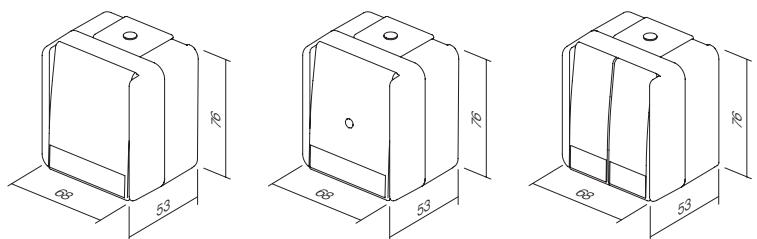
- 10AX 250V~, type SF70
- in accordance with EN 60669-1
- plug-in contacts 1.5-2.5mm²



P R I Z A T V F
S O C K E T S

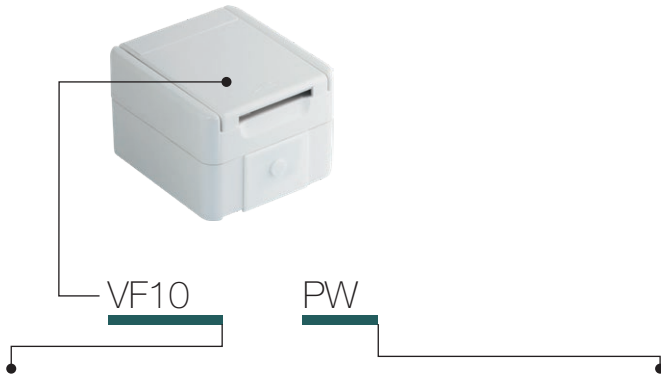

Iloji type	përshkrimi description	të dhënat teknike technical data	ngjyra colour
VF10	PRIZË SCHUKO+KAPAK SOCKET SCHUKO+COVER	IP44 2P+E 16A 250V~	<input type="checkbox"/> PW e bardhë-mat white-mat <input type="checkbox"/> GY gri-mat grey-mat



- VF10PW
- VF10GY

PRIZË SCHUKO+KAPAK IP44 2P+E 16 A 250 V~

- kontaktet e vidave 1,5-2,5 mm²
- 2P+E schuko+kapak
- 16 A 250 V~, Iloji VF10
- në përputhje me EN 60884-1, CEE7

SOCKET SCHUKO+COVER IP44 2P+E 16A 250V~

- screw contacts 1.5-2.5mm²
- 2P+E schuko+cover
- 16A 250V~, type VF10
- in accordance with EN 60884-1, CEE7



- VF12PW
- VF12GY

PRIZË SCHUKO+KAPAK IP44 2P+E 16 A 250 V~ BV

- BV kontakte për futje telash 1,5-2,5 mm²
- 2P+E schuko+kapak
- 16 A 250 V~, Iloji VF12
- në përputhje me EN 60884-1, CEE7

SOCKET SCHUKO+COVER IP44 2P+E 16A 250V~ BV

- BV plug-in contacts 1.5-2.5mm²
- 2P+E schuko+cover
- 16A 250V~, type VF12
- in accordance with EN 60884-1, CEE7

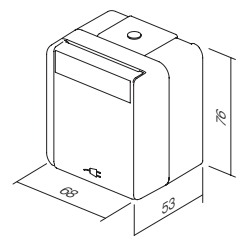

S E T S C F

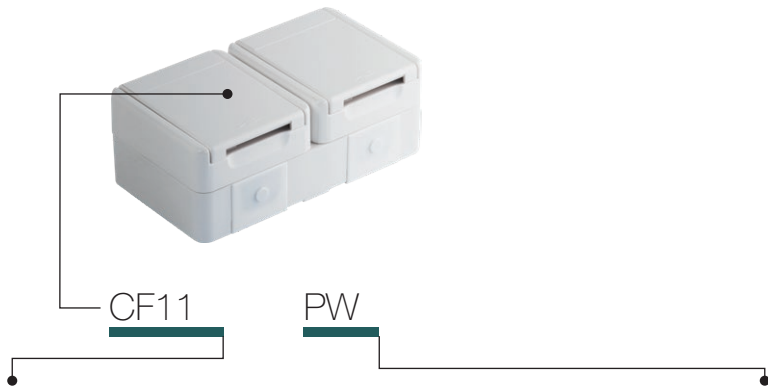

Iloji type	përshkrimi description	të dhënat teknike technical data	ngjyra colour
CF10	PRIZË SET SCHUKO DYSHE HORIZ SOCKET SET SCHUKO DOUBLE HORIZ	2x 2P+E 16A 250V~ IP44	<input type="checkbox"/> PW e bardhë-mat white-mat
CF11	PRIZË SET SCHUKO DYSHE VERT SOCKET SET SCHUKO DOUBLE VERT	2x 2P+E 16A 250V~ IP44	<input checked="" type="checkbox"/> GY gri-mat grey-mat
CF12	PRIZË SCH+ÇELËS 2 DREJTIME HORIZ SOCKET SCH+SWITCH 2WAY HORIZ	16A + 10A 250V~ IP44	
·	·	·	
·	·	·	

SET PRIZË SCHUKO DYSHE HORIZONTALE IP44 2x 2P+E 16 A 250 V~



- CF10PW
 CF10GY

- kontaktet e vidave 1,5-2,5 mm²
- 2x 2P+E schuko+kapak horizontale
- 16 A 250 V~, Iloji CF10
- në përputhje me EN 60884-1, CEE7

SOCKET SET SCHUKO DOUBLE HORIZONTAL IP44 2x 2P+E 16A 250V~

- screw contacts 1.5-2.5mm²
- 2x 2P+E schuko+cover horizontal
- 16A 250V~, type CF10
- in accordance with EN 60884-1, CEE7



SET PRIZË SCHUKO DYSHE VERTIKALE IP44 2x 2P+E 16 A 250 V~



- CF11PW
 CF11GY

- kontaktet e vidave 1,5-2,5 mm²
- 2x 2P+E schuko+kapak vertikale
- 16 A 250 V~, Iloji CF11
- në përputhje me EN 60884-1, CEE7

SOCKET SET SCHUKO DOUBLE VERTICAL IP44 2x 2P+E 16A 250V~

- screw contacts 1.5-2.5mm²
- 2x 2P+E schuko+cover vertical
- 16A 250V~, type CF11
- in accordance with EN 60884-1, CEE7



PRIZË SCH+SET ÇELËS 2 DREJTIME HORIZONTAL IP44 16 A + 10 A X 250 V~



- CF12PW
 CF12GY

- vidë (priza), futje (çelësi) kontaktet 1,5-2,5 mm²
- 2P+E schuko+kapak + çelës horizontal 2 drejtime
- 16 A + 10 A X 250 V~, Iloji CF12
- në përputhje me standardet EN 60884-1, CEE7, EN 60669-1

SOCKET SCH+SWITCH SET 2WAY HORIZONTAL IP44 16A + 10AX 250V~

- screw (socket), plug-in (switch) contacts 1.5-2.5mm²
- 2P+E schuko+cover + switch 2-way horizontal
- 16A + 10AX 250V~, type CF12
- in accordance with EN 60884-1, CEE7, EN 60669-1





- CF13PW
- CF13GY

PRIZË SCH+SET ÇELËS 2 DREJTIME VERTIKAL IP44 16 A + 10 A X 250 V~

- vidë (priza), futje (çelësi)
- kontakte për futje telash 1,5-2,5 mm²
- 2P+E schuko+kapak + çelës 2 drejtme vertikal
- 16 A + 10 A X 250 V~, lloji CF13
- në përputhje me standardet EN 60884-1, CEE7, EN 60669-1

SOCKET SCH+SWITCH 2WAY SET VERTICAL IP44 16A + 10AX 250V~

- screw (socket), plug-in (switch)
- contacts 1.5-2.5mm²
- 2P+E schuko+cover + switch 2-way vertical
- 16A + 10AX 250V~, type CF13
- in accordance with EN 60884-1, CEE7, EN 60669-1



- CF14PW
- CF14GY

SET PRIZË SCHUKO DYSHE HORIZONTALE IP44 2x 2P+E 16 A 250 V~ BV

- BV kontakte për futje telash 1,5-2,5 mm²
- 2x 2P+E schuko+kapak horizontale
- 16 A 250 V~, lloji CF14
- në përputhje me EN 60884-1, CEE7

SOCKET SET SCHUKO DOUBLE HORIZONTAL IP44 2x 2P+E 16A 250V~ BV

- BV plug-in contacts 1.5-2.5mm²
- 2x 2P+E schuko+cover horizontal
- 16A 250V~, type CF14
- in accordance with EN 60884-1, CEE7



- CF15PW
- CF15GY

SET PRIZË SCHUKO DYSHE VERTIKALE IP44 2x 2P+E 16 A 250 V~ BV

- BV kontakte për futje telash 1,5-2,5 mm²
- 2x 2P+E schuko+kapak vertikale
- 16 A 250 V~, lloji CF15
- në përputhje me EN 60884-1, CEE7

SOCKET SET SCHUKO DOUBLE VERTICAL IP44 2x 2P+E 16A 250V~ BV

- BV plug-in contacts 1.5-2.5mm²
- 2x 2P+E schuko+cover vertical
- 16A 250V~, type CF15
- in accordance with EN 60884-1, CEE7



- CF16PW
- CF16GY

PRIZË+SET ÇELËS SCH+2 DREJTME HORIZONTAL IP44 16 A + 10 A X 250 V~ BV

- BV kontakte për futje telash 1,5-2,5 mm²
- 2P+E schuko+kapak + çelës 2 drejtme horizontalisht
- 16 A + 10 A X 250 V~, lloji CF16
- në përputhje me standardet EN 60884-1, CEE7, EN 60669-1

SOCKET+SWITCH SET SCH+2WAY HORIZONTAL IP44 16A + 10AX 250V~ BV

- BV plug-in contacts 1.5-2.5mm²
- 2P+E schuko+cover + switch 2-way horizontal
- 16A + 10AX 250V~, type CF16
- in accordance with EN 60884-1, CEE7, EN 60669-1



- CF17PW
- CF17GY

PRIZË SCH+SET ÇELËS 2 DREJTME VERTIKAL IP44 16 A + 10 A X 250 V~ BV

- BV kontakte për futje telash 1,5-2,5 mm²
- 2P+E schuko+kapak + çelës 2 drejtme vertikal
- 16 A + 10 A X 250 V~, lloji CF17
- në përputhje me standardet EN 60884-1, CEE7, EN 60669-1

SOCKET SCH+SWITCH 2WAY SET VERTICAL IP44 16A + 10AX 250V~ BV

- BV plug-in contacts 1.5-2.5mm²
- 2P+E schuko+cover + switch 2-way vertical
- 16A + 10AX 250V~, type CF17
- in accordance with EN 60884-1, CEE7, EN 60669-1



A K S E S O R Ë T A F

A C C E S S O R I E S

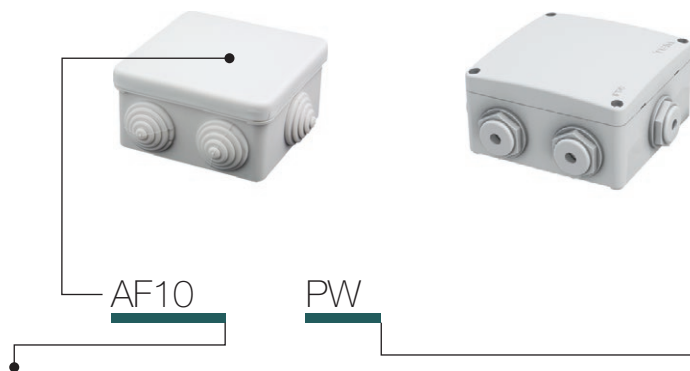

Iloji type	përshkrimi description	të dhënat teknike technical data	ngjyra colour
AF10	KUTI SHPËRNDARJEJE DISTRIBUTION BOX	IP44 RN01	<input type="checkbox"/> PW e bardhë-mat white-mat
AF20	KUTI SHPËRNDARJEJE DISTRIBUTION BOX	IP55 NDO1	<input checked="" type="checkbox"/> GY gri-mat grey-mat

KUTI SHPËRNDARJEJE IP44 RN01



- AF10PW
- AF10GY

- kuti shpërndarjeje me montim në sipërfaqe IP44
- 16 A 400V~
- në përputhje me standardet IEC/EN 60670-1, IEC/EN 60670-22

DISTRIBUTION BOX IP44 RN01

- surface mounting distribution box IP44
- 16A 400V~
- in accordance with IEC/EN 60670-1, IEC/EN 60670-22

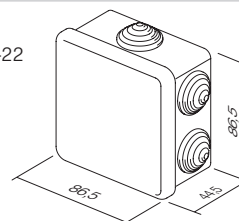

KUTI SHPËRNDARJEJE IP55 ND01



- AF20PW
- AF20GY

- kuti lidhjeje me montim në sipërfaqe IP55
- xhantot përfshihen
- në përputhje me standardet IEC/EN 60670-1, IEC/EN 60670-22

DISTRIBUTION BOX IP55 ND01

- surface mounting connection box IP55
- glands included
- in accordance with IEC/EN 60670-1, IEC/EN 60670-22

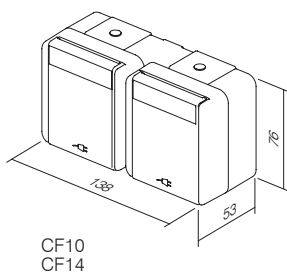
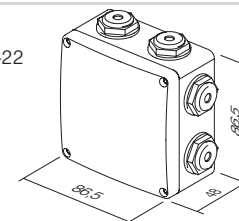

CF10
CF14

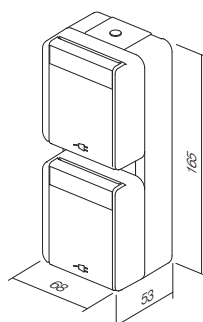

CF11
CF15

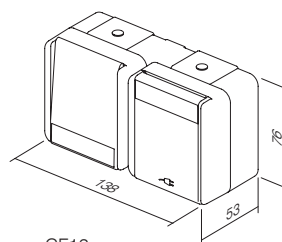

CF12
CF16

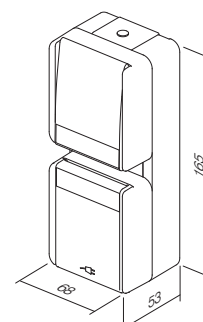

CF13
CF17

MODUL

kodi	Përshkrimi i produktit	faqe	kodi	Përshkrimi i produktit	faqe
ÇELËSAT SM			KOMUNIKIMET KM		
SM10	ÇELËS ME 1 DREJTIM 16 A X 250 V~ 1M	68	KM10--	PRIZË TV BAZË 0dB 1M	82
SM11	BUTON ME SHYTPJE ME 1 DREJTIM 16 A 250 V~ 1M	68	KM20--	PRIZË TV BAZË 0dB 2M	82
SM12	ÇELËS ME 1 DREJTIM 20 A 250 V~ 1M	68	KM11--	PRIZË TV ME KAPAK FUNDOR 1dB 1M	82
SM20	ÇELËS 2 POLAR 16 A X 250 V~ 1M	68	KM12--	PRIZË TV KALJESE 10dB 1M	82
SM40	MBYLLËSE ÇELËSI 1-0-2 16 A X 250 V~ 1M	69	KM15--	PRIZË SAT BAZË 0dB 1M	83
SM41	MBYLLËSE BUTONI ME SHYTPJE 1-0-2 16 A 250 V~ 1M	69	KM24--	PRIZË SAT BAZË 0dB 2M	83
SM60	ÇELËS ME 2 DREJTIME 16 A X 250 V~ 1M	69	KM16--	PRIZË SAT ME KAPAK FUNDOR 1dB 1M	83
SM61	BUTON ME SHYTPJE ME 2 DREJTIME 16 A 250 V~ 1M	69	KM19--	PRIZË R BAZË 0dB 1M	83
SM70	ÇELËS NDËRMJETËS 16 A X 250 V~ 1M	69	KM29--	PRIZË R BAZË 0dB 2M	83
SM10--	ÇELËS ME 1 DREJTIM 16 A X 250 V~ 1M	70	KM25--	PRIZË SAT-TV ME KAPAK FUNDOR 1dB 2M	83
SM10--IN	ÇELËS ME 1 DREJTIM 16 A X 250 V~ 1M IN	70	KM22--	PRIZË AUDIO 2xRCA 1M	84
SM11--	BUTON ME SHYTPJE ME 1 DREJTIM 16 A 250 V~ 1M	70	KM23--	PRIZË AUDIO ALTOPARLANTË 1M	84
SM11--IN01	BUTON ME SHYTPJE ME 1 DREJTIM 16 A 250 V~ 1M IN 01	70	KM26--	PRIZË AUDIO ALTOPARLANTË 2M	84
SM11--IN02	BUTON ME SHYTPJE ME 1 DREJTIM 16 A 250 V~ 1M IN 02	71	KM30--	PRIZË TEL LT RJ11 6/4 1M	85
SM20--NT03	ÇELËS 2 POLAR 16 A X 250 V~ 1M NT 03	71	KM31--	PRIZË TEL BT SEC 6/6 1M	85
SM20--IN	ÇELËS 2 POLAR 16 A X 250 V~ 1M IN	71	KM36--	PRIZË TEL KS RJ11 6/4 1M	85
SM40--NT10	MBYLLËSE ÇELËSI 1-0-2 16 A X 250 V~ 1M NT 10	71	KM37--	PRIZË CAT5e KS RJ45 8/8 1M	85
SM41--NT10	MBYLLËSE BUTONI ME SHYTPJE 1-0-2 16 A 250 V~ 1M __ NT 10	71	KM35--	PËRSHTATËS KS 1M	85
SM60--	ÇELËS ME 2 DREJTIME 16 A X 250 V~ 1M	71	KM38--	PËRSHTATËS KS ME MBROJTJE NGA PLUHURI 1M	85
SM61--	BUTON ME SHYTPJE ME 2 DREJTIME 16 A 250 V~ 1M	72	KM39--	PRIZË CAT6 SCH KS RJ45 8/8 1M	86
SM62--CD	BUTON ME SHYTPJE ME 2 DREJTIME ME KORDON 16 A 250 V~ 1M __ CD	72	KM50--	PËRSHTATËS KS UNIVERSAL 1M	86
SM70--	ÇELËS NDËRMJETËS 16 A X 250 V~ 1M	72	KM40--	PËRSHTATËS PD 1M	86
BUTONAT TM			KM43--	PËRSHTATËS PD ME MBROJTJE NGA PLUHURI 1M	86
TM11--	BUTON 1M	73	KM46--	PËRSHTATËS R&M 1M	86
TM11--IN	BUTON 1M IN	73	KM52--	PËRSHTATËS R&M CAT6A 1M	86
TM12--	BUTON 2M	73	KM47--	PËRSHTATËS R&M ME MBROJTJE NGA PLUHURI 1M	87
TM12--IN	BUTON 2M IN	73	KM53--	PËRSHTATËS R&M CAT6A ME MBROJTJE NGA PLUHURI 1M	87
TM13--IL	BUTON 2M ME KAPAK ME MBISHKRIM	74	KM45--	PËRSHTATËS LK 1M	88
TM15--	BUTON 1M 2 POLAR	74	KA26	PËRSHTATËS NEXANS/SCHRACK 2M	88
TM21--	FALSO 1M	74	KM48--	PËRSHTATËS AT&T SYSTIMAX ME MBROJTJE NGA PLUHURI 1M	88
TM22--	FALSO 2M	74	KM51--	PRIZË USB LLOJI A 1M	88
TM31--	DALJE PËR KABLLO 1M	74	AKSESORËT E KOMUNIKIMIT KA		
NDRIQËSIT IA			KA10	KONEKTOR KS RJ11 RJ11 6/4	89
IA100R	LLAMBË NEONI 230 V~ 0,34 W	76	KA11	KONEKTOR KS CAT5e RJ45 8/8	89
IA20--	LLAMBË LED 230 V AC/DC 0,4W	76	KA12	KONEKTOR KS CAT5eS RJ45 8/8	89
IA21--	LLAMBË LED 24 V AC/DC 0,2W	76	KA15	KONEKTOR KS RJ45 SCHRACK RJ45 8/8	89
IA22--	LLAMBË LED 12V AC/DC 0,10W	76	KA16	KONEKTOR KS RJ45 SCHRACK RJ45 8/8	89
IA50	QARK RC 250 V	76	KA17	KONEKTOR KS CAT6a SCHRACK RJ45 8/8	89
PRIZAT VM			KA18	KONEKTOR KS RJ45 SCHRACK RJ45 8/8	90
VM10--	PRIZË SCHUKO+KS 2P+E 16 A 250 V~ 2M	78	KA27	KONEKTOR KS HDMI	90
VM11--	PRIZË SCHUKO+KS+KAPAK 2P+E 16 A 250 V~ 2M	78	KA28	KABLLO KS HDMI	90
VM20--	PRIZË EURO+KS 2P 10A 250 V~ 1M	79	LIDHJET ELEKTRONIKE EM		
VM40--	PRIZË FRANCEZE+KS 2P+E 16 A 250 V~ 2M	79	EM10--	REOSTAT RROTULLUES R 300W 1M	91
VM41--	PRIZË FRANCEZE+KS+KAPAK 2P+E 16 A 250 V~ 2M	79	EM12--	REOSTAT RROTULLUES/2 DREJTIME 300W 1M	91
VM30--	PRIZË ITALIANE P17/11+KS 2P+E 16 A 250 V~ 1M	79	EM13--	REOSTAT RROTULLUES/2 DREJTIME LED 60W 1M	92
VM31--	PRIZË SCHUKO/ITALIANE P17/11+KS 2P+E 16 A 250 V~ 2M	79	EM14--	REOSTAT RROTULLUES/2 DREJTIME LED 180W 1M	92
VM32--	PRIZË SCHUKO/ITALIANE P30+KS 2P+E 16 A 250 V~ 2M	80	EM15--	REOSTAT RROTULLUES R 250W 1M	92
VM33--	PRIZË ITALIANE P11+KS 2P+E 10A 250 V~ 1M	80	EM23	REOSTAT ME MONTIM NË KUTI R (250 W), (RC, RL 200VA)	93
VM21--	PRIZË EURO/AMERIKANE+KS 2P 16A 250 V~ 1M	80	EM18	REOSTAT ME MONTIM NË KUTI LED 250 W	93
VM51--	PRIZË BRITANIKE BS546+KS 2P+E 15A 250 V~ 2M	80	EM19	REOSTAT ME MONTIM NË KUTI DC LED 96 W	93
VM52--	PRIZË BRITANIKE BS 1363+KS 2P+E 13A 250 V~ 2M	80	EM25--	ÇELËS / REOSTAT UNIVERSAL RLC 0-300W 2M	95
VM80	MBROJTËS NGA MBIRRYMA MPE MINI 275 V/50 Hz	80	EM26--	NJËSI KONTROLLI ME BUTON ME SHYTPJE 2M	97
			EM27	FILTËR FREKUJENCE	97
			EM25PPOL20	SET ÇELËS / REOSTAT RLC 0-300W 2M PP OL20	97
			EM31--	ÇELËS IR 5 A 230 V~ 1M	98
			EM32--	ÇELËS IR 5 A 230 V~ 2M	98
			EM37--	TËRMOSTAT BAZË 6 A 230 V ~ 2M	100
			NM39	KORNIZË MONTIMI ME VIDA PËR TËRMOSTATE FANTINI COSMI 3M	101
			EM40--	ÇELËSI I KARTËS SË KURSIMIT TË ENERJISË 3 A 250 V~ 3M	101
			EM47	KARTË ISO	101
			EM44--	ÇELËS KARTË PËR KURSIMI TË ENERJISË RF HF 13,56 MHz 3M	102
			EM49	NJËSI KONTROLLI E KURSIMIT TË ENERJISË 2x16 A 250 V~	102
			EM45	SHPËRNDARËS SPL-1	102
			EM60--	PRIZË PËR RROJË 230 V~/120 V~ 3M	103
			EM66--	NJËSIA E FURNIZIMIT ME ENERJJI USB 5 V 2,1 A 1M	103
			EM65--	NJËSI FURNIZIMI ME ENERJJI USB 5 V 1 A 2M	103
			EM67--	NJËSIA E FURNIZIMIT ME ENERJJI USB 5 V 2,4 A 1M	104
			EM55	DRITË EMERGJENCE LED 250 V~ 0,90 W, NiCd 3h 7M	104
			EM57	DRITË EMERGJENCE LED 230 V~50 Hz, 0,5 W, NiMH 2 ORË 2M	104
			EM50--	LLAMBË LED NJËNGJYRËSE 250 V~ 0,8 W 2M	105
			EM51--	LLAMBË LED ME DY NGJYRA 250 V~ 2 x 0,4 W 2M	105
			EM52--	LLAMBË LED 3D ME DY NGJYRA 250 V~ 2 x 0,4 W 2M	105
			EM71--	ÇELËS ME GJURMË GISHTI BIOPASS 2M	106
			EM80--	ÇELËS, PA PREKJE 10 A 240 V~	107
			EM81--	ÇELËS, PA PREKJE	107
			EM90--	SINJALIZUES 8 VA 230 V~1M	108
			EM91--	SINJALIZUES 8 VA 12 V~1M	108
			EM92--	ZILE 8 VA 230 V~1M	108
			EM93--	ZILE 8 VA 12V~1M	108
			EM95--	KONTROLL VOLUMI 100 V LINJË AUDIO 35 W 2M	109
			EM96--	KONTROLL VOLUMI 4-8 Ω 35 W 2M	109

kodi	Përshkrimi i produktit	faqe	kodi	Përshkrimi i produktit	faqe
SETI CM			KUTITË E RRUMBULLAKËTA		
CM10--	SET PRIZASH 2x SCHUKO 2P+E 16 A 250 V~ 4M	110	DE10	KUTI E RRUMBULLAKËT TULLË SM60-01	140
CM11--	SET PRIZASH 3x SCHUKO 2P+E 16 A 250 V~ 7M	110	DE11	KUTI E RRUMBULLAKËT TULLË E THELLË SM60-06	140
CM15	SET LIDHJEJE 3x1,5 mm2 1M	111	DE30	KAPËSE E KOMBINUAR SM60-03	140
CM16	SET LIDHJEJE 3x2,5 mm2 2M	111	DE31	KAPËSE E KOMBINUAR SM60-04	140
CM17	SET VIDASH 3,5x20	111	DE12	KUTI E RRUMBULLAKËT TULLË 65-46	141
CM18	SET VIDASH 3,5x35	111	DE13	KUTI E RRUMBULLAKËT TULLË 65-60	141
CM19	SET VIDASH 3,5x50	111	DE14	PJESË SHITESË PËR MD 65-46	141
CM22--	SET ÇELËSASH IP44 2M	111	DE32	KAPËSE E KOMBINUAR MD 65-71	141
CM23--	SET PRIZASH IP44 2M	111	DE33	KAPËSE E KOMBINUAR MD 65-91	141
CM25--OL	SET ÇELËSASH PËR BANJË 3x20 A 250 V~ 4M OL	111	DE20	KAPAK MBROJTËS PËR KUTI 60	141
CM25--OS	SET ÇELËSASH PËR BANJË 3x20 A 250 V~ 4M OS	111	DE21	KAPAK MBROJTËS PËR KUTI 65	141
NM41	SET KORNIZË MONTIMI PËR BANJË 4M	112	DE22	KAPAK DEKORATIV PËR KUTI SM60	141
OL41--	SET KAPAKU MBULUES LINE PËR BANJË	112	HE10	KUTI E RRUMBULLAKËT MUR BOSH SM68x40	144
OS41--	SET KAPAKU MBULUES SOFT PËR BANJË	112	HE11	KUTI E RRUMBULLAKËT MUR BOSH SM68x55	144
PROGRAMI ANTIBAKTERIAL AW			BE10	KUTI E RRUMBULLAKËT BETON 60-49	144
TM11AW	BUTON 1M	115	BE11	KUTI E RRUMBULLAKËT BETON 60-77	144
TM11AWIN	BUTON 1M IN	115	BE20	KUNDËR-SUPORT KUTIE PËR BETON	144
TM12AW	BUTON 2M	115	BE21	KUTI PËR BETON PËR BLOKUES TUBI 16	144
TM12AWIN	BUTON 2M IN	115	KUTITË DREJTKËNDORE		
TM21AW	FALSO 1M	115	DM30	KUTI DREJTKËNDORE TULLË PM3	148
TM22AW	FALSO 2M	115	DM31	KUTI DREJTKËNDORE TULLË PM3 PM3-65	148
VM10AW	PRIZË SCHUKO+KS 2P+E 16 A 250 V~ 2M	116	DM40	KUTI DREJTKËNDORE TULLË PM4	148
VM11AW	PRIZË SCHUKO+KS+KAPAK 2P+E 16 A 250 V~ 2M	116	DM41	KUTI DREJTKËNDORE TULLË PM4 PM4-65	148
VM20AW	PRIZË EURO+KS 2P 10A 250 V~ 1M	116	DM70	KUTI DREJTKËNDORE TULLË PM7	149
KM11AW	PRIZË TV ME KAPAK FUNDOR 1dB 1M	116	DM71	KUTI DREJTKËNDORE TULLË PM7-65	149
KM35AW	PËRSHTATËS KS 1M	116	DM72	KUTI DREJTKËNDORE TULLË PM72-65	149
OS20AW	KAPAK MBULUES SOFT 2M	117	DM80	PJESË DISTANCUESE PËR KUTI PM	149
OS24AW	KAPAK MBULUES SOFT 2x2M	117	DM33	KAPAK MBROJTËS PËR KUTI PM3	150
OS26AW	KAPAK MBULUES SOFT 3x2M	117	DM34	KAPAK DEKORATIV PËR KUTI PM3	150
OS30AW	KAPAK MBULUES SOFT 3M	117	DM43	KAPAK MBROJTËS PËR KUTI PM4	150
OS40AW	KAPAK MBULUES SOFT 4M	117	DM44	KAPAK DEKORATIV PËR KUTI PM4	150
OS70AW	KAPAK MBULUES SOFT 7M	117	DM73	KAPAK MBROJTËS PËR KUTI PM7PM7	150
KAPAKËT MBULUES PURE OP			DM74	KAPAK DEKORATIV PËR KUTI PM7	150
OP20--	KAPAK MBULUES PURE 2M	120	DM75	KAPAK DEKORATIV PËR KUTI PM72	151
OP24--	KAPAK MBULUES PURE 2x2M	120	HM30	KUTI DREJTKËNDORE MUR BOSH VM3	152
OP26--	KAPAK MBULUES PURE 3x2M	120	HM40	KUTI DREJTKËNDORE MUR BOSH VM4	152
OP28--	KAPAK MBULUES PURE 4x2M	120	HM70	KUTI DREJTKËNDORE MUR BOSH VM7	152
OP30--	KAPAK MBULUES PURE 3M	121	HM72	KUTI DREJTKËNDORE MUR BOSH VM72	152
OP40--	KAPAK MBULUES PURE 4M	121	BM30	KUTI DREJTKËNDORE BETON BM3	153
OP70--	KAPAK MBULUES PURE 7M	121	BM40	KUTI DREJTKËNDORE BETON BM4	153
OP13--	KAPAK MBULUES PURE 1/3M	121	BM70	KUTI DREJTKËNDORE BETON BM7	153
OP23--	KAPAK MBULUES PURE 2/3M	121	BM80	KAPËSE FIKSUESE E KOMBINUAR BM	153
KAPAKËT MBULUES LINE OL			BM82	PJESË DISTANCUESE PËR KUTI BM	153
OL20--	KAPAK MBULUES LINE 2M	124	KUTITË LIDHËSE		
OL24--	KAPAK MBULUES LINE 2x2M	124	DW10	KUTI E RRUMBULLAKËT TULLË PËR LIDHJE DSM78	156
OL26--	KAPAK MBULUES LINE 3x2M	124	HW10	KUTI E RRUMBULLAKËT MUR BOSH PËR LIDHJE SM78x45	156
OL28--	KAPAK MBULUES LINE 4x2M	124	DE23	KAPAK DEKORATIV PËR KUTI SM78	156
OL29--	KAPAK MBULUES LINE 5x2M	124	DE24	KAPAK MBROJTËS PËR KUTI 78	156
OL30--	KAPAK MBULUES LINE 3M	125	HW20	KUTI KATRORE TULLË PËR LIDHJE SM105x105	156
OL40--	KAPAK MBULUES LINE 4M	125	AKSESORËT E LIDHJEVE		
OL70--	KAPAK MBULUES LINE 7M	125	UW10--	BLLOQE TERMINALES ME 1 RADHË TË MBYLLURA PC 2x2,5 mm ² 10P	158
OL10--	KAPAK MBULUES LINE 1/2M	125	UW11--	BLLOQE TERMINALES ME 1 RADHË TË MBYLLURA PC 2x4 mm ² 10P	158
OL13--	KAPAK MBULUES LINE 1/3M	125	UW12--	BLLOQE TERMINALES ME 1 RADHË TË MBYLLURA PC 2x6 mm ² 10P	158
OL23--	KAPAK MBULUES LINE 2/3M	125	UW15--	BLLOQE TERMINALES ME 1 RADHË PA 2x2,5 mm ² 12P	158
KAPAKËT MBULUES SOFT OS			UW16--	BLLOQE TERMINALES ME 1 RADHË PA 2x4 mm ² 12P	158
OS20--	KAPAK MBULUES SOFT 2M	128	UW17--	BLLOQE TERMINALES ME 1 RADHË PA 2x6 mm ² 12P	158
OS24--	KAPAK MBULUES SOFT 2x2M	128	UW29--	BLLOQE TERMINALES ME 2 RADHË PP 10-4,0 mm ² 12P	158
OS26--	KAPAK MBULUES SOFT 3x2M	128	UW30--	BLLOQE TERMINALES ME 2 RADHË PP 1,5-6,0 mm ² 12P	158
OS28--	KAPAK MBULUES SOFT 4x2M	128	UW31--	BLLOQE TERMINALES ME 2 RADHË PP 2,5-10 mm ² 12P	158
OS30--	KAPAK MBULUES SOFT 3M	129	UW32--	BLLOQE TERMINALES ME 2 RADHË PP 4,0-16 mm ² 12P	158
OS40--	KAPAK MBULUES SOFT 4M	129	UW25--	BLLOQE TERMINALES ME 2 RADHË PA 1,0-4,0 mm ² 12P	159
OS70--	KAPAK MBULUES SOFT 7M	129	UW26--	BLLOQE TERMINALES ME 2 RADHË PA 1,5-6,0 mm ² 12P	159
OS72--	KAPAK MBULUES SOFT 2x7M	129	UW27--	BLLOQE TERMINALES ME 2 RADHË 2,5-10 mm ² 12P	159
OS10--	KAPAK MBULUES 1/2M	129	UW28--	BLLOQE TERMINALES ME 2 RADHË PA 4,0-16mm ² 12P	159
OS13--	KAPAK MBULUES SOFT 1/3M	129	UW40--	KONEKTORË PËR FUTJE TELASH PA 1,5 mm ² 3P	159
OS23--	KAPAK MBULUES SOFT 2/3M	129	UW41--	KONEKTORË PËR FUTJE TELASH PA 1,5 mm ² 5P	159
KORNIZAT E MONTIMIT NM			UW42--	KONEKTORË PËR FUTJE TELASH PA 1,5 mm ² 8P	159
NM20	KORNIZË MONTIMI ME KTHETRA 2M	134	UW45--	KONEKTORË PËR FUTJE TELASH PA 2,5mm ² 3P	159
NM21	KORNIZË MONTIMI PA VIDA 2M	134	UW46--	KONEKTORË PËR FUTJE TELASH PA 2,5mm ² 4P	159
NM24	KORNIZË MONTIMI METALIKE ME KTHETRA 2M	134	UW47--	KONEKTORË PËR FUTJE TELASH PA 2,5mm ² 5P	159
NM25	KORNIZË MONTIMI METALIKE PA VIDA 2M	134	UW50--	KONEKTORË PËR FUTJE TELASH PA 2,5mm ² 2/1P	159
NM30	KORNIZË MONTIMI ME VIDA 3M	135			
NM40	KORNIZË MONTIMI ME VIDA 4M	135			
NM70	KORNIZË MONTIMI ME VIDA 7M	135			
NM72	KORNIZË MONTIMI ME VIDA 2x7M	135			
NM10	KORNIZË MONTIMI ME KTHETRA 1/2M	136			
NM11	KORNIZË MONTIMI PA VIDA 1/2M	136			
NM23	KORNIZË MONTIMI ME KTHETRA 2/3M	136			
NM32	KORNIZË MONTIMI ME VIDA 2/3M	136			

shpërndarja

kodi	Përshkrimi i produktit	faqe
KUTI CUBO IP20 AC		
AC11--	KUTI NO CUBO ME KAPAK TË PASMË ANËSOR IP20 1M	162
AC21--	KUTI NO CUBO ME KAPAK TË PASMË ANËSOR IP20 2M	162
AC41--	KUTI NO CUBO ME KAPAK TË PASMË ANËSOR IP20 4M	162
AC61--	KUTI NO CUBO ME KAPAK TË PASMË ANËSOR IP20 6M	162
KUTI CUBO IP55 AQ		
AQ20--	KUTI NO CUBO IP55 2M	163
AQ22--	KUTI NO CUBO IP55 2x2M	163
AQ30--	KUTI NO CUBO IP55 3M	163
AQ31--	KUTI PO CUBO IP55 3M	163
AQ21--	KUTI PO CUBO IP55 2M	164
SISTEME KANALINASH ALUMINI MA		
RT10	PËRSHTATËS MA 162	165
RT12--	KAPAK MBULLUES MA 92 2/3M	165
RT14--	KAPAK MBULLUES MA 162 4M	165
RT17--	KAPAK MBULLUES MA 162 7M	165
RT20--	BAZË PËR KANALINA MA 130x65	166
RT21--	BAZË PËR KANALINA MA 165x65	166
RT25--	KAPAK I PËRPARMË MA 92	166
RT30	RAFT KABLLOSH MA 43	166
RT31	RAFT KABLLOSH MA 43 AL	166
RT32	RAFT KABLLOSH MA 43 AL DYSH	166
RT35--	ELEMENT FUNDOR BLOKUES MA 130x65	167
RT36--	ELEMENT FUNDOR BLOKUES MA 165x65	167
RT38	SET PJSË BASHKUESE MA 65	167
RT40--	KËND UNIVERSAL MA 130x65	167
RT41--	KËND UNIVERSAL MA 165x65	167
RT42	PJSË TOKËZIMI MA 2x A6.3	167
RT43--	BËRRYL L MA 130x65	168
RT44--	BËRRYL L MA 165x65	168
RT45--	BËRRYL T MA 130x65	168
RT46--	BËRRYL T MA 165x65	168
RT50--	PLLAKËZ FIKSUESE MA NJËSHE 130x65	169
RT51--	PLLAKËZ FIKSUESE MA DYSHE 130x65	169
RT52--	KABINË SHËRBIMI MA 130x65x500	169
RT53--	KABINË SHËRBIMI MA DYSHE 130x65x500	169
KUTI DYSHEMEJE MT		
RB30	KUTI DYSHEMEJE MT 7 H=53mm	171
RB40	KUTI DYSHEMEJE MT 7 H=88mm	171
RB31	FLANXHË KUTIE DYSHEMEJE MT 7 H=53mm	171
RB41	FLANXHË KUTIE DYSHEMEJE MT 7 H=88mm	171
RB33	KUTI DYSHEMEJE MT 14 H=53mm	171
RB43	KUTI DYSHEMEJE MT 14 H=88mm	171
RB34	FLANXHË KUTIE DYSHEMEJE MT 14 H=53mm	172
RB44	FLANXHË KUTIE DYSHEMEJE MT 14 H=88mm	172
RB36	KUTI DYSHEMEJE MT 21 H=53mm	172
RB46	KUTI DYSHEMEJE MT 21 H=88mm	172
RB37	FLANXHË KUTIE DYSHEMEJE MT 21 H=53mm	172
RB47	FLANXHË KUTIE DYSHEMEJE MT 21 H=88mm	172
QARQE SHPËRNDARJEJE MO		
RB10	PËRSHTATËS PËR SHINË DIN 35 mm 1M	173
RB11	PËRSHTATËS PËR SHINË DIN 35 mm 2M	173
RB20	KUTI SHPËRNDARJEJE MO 12+2	174
RB21	KUTI SHPËRNDARJEJE MO 24+4	174
RB22	KUTI SHPËRNDARJEJE MO 36+6	174
RB23	KUTI SHPËRNDARJEJE MO 48+8	174

ekonomik

kodi	Përshkrimi i produktit	faqe
ÇELËSAT SE		
SE10	ÇELËS ME 1 DREJTIM 10 A X 250 V~	188
SE11	BUTON ME SHTYPJE ME 1 DREJTIM 10 A 250 V~	188
SE22	ÇELËS 2 POLAR 16 A X 250 V~	188
SE50	ÇELËS ME 2 POZICIONE - 1 DREJTIM 10 A X 250 V~	188
SE51	BUTON ME SHTYPJE ME 2 POZICIONE - 1 DREJTIM 10 A 250 V~	189
SE52	MBYLLËSE ÇELËSI 10 A X 250 V~	189
SE53	MBYLLËSE BUTONI ME SHTYPJE 10 A 250 V~	189
SE60	ÇELËS ME 2 DREJTIME 10 A X 250 V~	189
SE63	ÇELËS DYSH ME 2 DREJTIME 10 A X 250 V~	189
SE70	ÇELËS NDËRMJETËS 10 A X 250 V~	189
SE10--	ÇELËS ME 1 DREJTIM 10 A X 250 V~	190
SE10--IN	ÇELËS ME 1 DREJTIM 10 A X 250 V~ IN	190
SE11--	BUTON ME SHTYPJE ME 1 DREJTIM 10 A 250 V~	190
SE11--TI50	BUTON ME SHTYPJE ME 1 DREJTIM 10 A 250 V~ TI 50	190
SE11--TI51	BUTON ME SHTYPJE ME 1 DREJTIM 10 A 250 V~ TI 51	190
SE11--IL	BUTON ME SHTYPJE ME 1 DREJTIM 10A 250 V~ IL	190
SE22--IN03	ÇELËS 2 POLAR 16 A X 250 V~ IN 03	190
SE50--	ÇELËS ME 2 POZICIONE - 1 DREJTIM 10 A X 250 V~	191
SE51--	BUTON ME SHTYPJE ME 2 POZICIONE - 1 DREJTIM 10 A 250 V~	191
SE52--NT09	MBYLLËSE ÇELËSI 10 A X 250 V~ NT 09	191
SE53--NT09	MBYLLËSE BUTONI ME SHTYPJE 10 A 250 V~ NT 09	191
SE60--	ÇELËS ME 2 DREJTIME 10 A X 250 V~	191
SE63--	ÇELËS DYSH ME 2 DREJTIME 10 A X 250 V~	191
SE70--	ÇELËS NDËRMJETËS 10 A X 250 V~	191
BUTONAT TE		
TE10--	BUTON ME 1 POZICION	192
TE10--IN	TREGUES BUTONI	192
TE13--IL	BUTON ME KAPAK ME MBISHKRIM IL	192
TE11--	BUTON ME 2 POZICIONE	192
NDRIQUESIT IA		
IA10--	LLAMBË NEONI 230 V~ 0,34 W	193
IA20--	LLAMBË LED 230 V~ AC/DC 0,4 W	193
IA21--	LLAMBË LED 24 V AC/DC 0,2W	193
IA22--	LLAMBË LED 12 V AC/DC 0,1W	193
PRIZAT VE		
VE10--XO	PRIZË SCHUKO 2P+E 16 A 250 V~ XO	196
VE11--XO	PRIZË SCHUKO+KAPAK 2P+E 16 A 250 V~ XO	196
VE12--XO	PRIZË SCHUKO 2P+E 16 A 250 V~ BV XO	196
VE13--XO	PRIZË SCHUKO+POKROV 2P+E 16 A 250 V~ BV XO	196
VE10--	PRIZË SCHUKO 2P+E 16 A 250 V~	196
VE11--	PRIZË SCHUKO+KAPAK 2P+E 16 A 250 V~	196
VE12--	PRIZË SCHUKO 2P+E 16 A 250 V~ BV	196
VE13--	PRIZË SCHUKO+KAPAK 2P+E 16 A 250 V~ BV	196
VE40--XO	PRIZË FRANCEZE 2P+E 16 A 250 V~ XO	197
VE41--XO	PRIZË FRANCEZE+KAPAK 2P+E 16 A 250 V~ XO	197
VE42--XO	PRIZË FRANCEZE 2P+E 16 A 250 V~ BV XO	197
VE43--XO	PRIZË FRANCEZE+KAPAK 2P+E 16 A 250 V~ BV XO	197
VE40--	PRIZË FRANCEZE 2P+E 16 A 250 V~	197
VE41--	PRIZË FRANCEZE+KAPAK 2P+E 16 A 250 V~	197
VE42--	PRIZË FRANCEZE 2P+E 16 A 250 V~ BV	197
VE43--	PRIZË FRANCEZE+KAPAK 2P+E 16 A 250 V~ BV	197
VE16--	PRIZË SCHUKO DYSHE 2P+E 16 A 250 V~	198
VE46--	PRIZË FRANCEZE DYSHE 2P+E 16 A 250 V~	198
VE30--	PRIZË 2P 16 A 250 V~	198
KOMUNIKIMET KE		
KE11	PRIZË TV-R ME KAPAK FUNDOR 1dB	199
KE12	PRIZË TV-R KALUESE 10dB	199
KE16	PRIZË SAT-TV-R ME KAPAK FUNDOR 3dB	199
KE36	PRIZË TEL KS RJ11 6/4	199
KE37	PRIZË CAT5e KS RJ45 8/8	200
KE40	PRIZË CAT6s KS RJ45 8/8 SLIM	200
KE38	PRIZË TEL KS DYSHE 2x RJ11 6/4	200
KE39	PRIZË CAT5e KS DYSHE 2x RJ45 8/8	200
KE41	PRIZË CAT6s KS DYSHE 2x RJ45 8/8 SLIM	200
KE45	PËRSHTATËS KS NJËSH	200
KE46	PËRSHTATËS KS DYSH	201
KE47	PËRSHTATËS PD DYSH	201
KE10--	PRIZË TV BAZË 0dB	202
KE11--	PRIZË TV-R ME KAPAK FUNDOR 1dB	202
KE12--	PRIZË TV-R KALUESE 10dB	202
KE16--	PRIZË SAT-TV-R ME KAPAK FUNDOR 3dB	202
KE22--	PRIZË AUDIO 2xRCA	202
KE23--	PRIZË AUDIO ALTOPARLANTË	202
KE36--	PRIZË TEL KS RJ11 6/4	202
KE37--	PRIZË CAT5e KS RJ45 8/8	203
KE40--	PRIZË CAT6s KS RJ45 8/8 SLIM	203
KE38--	PRIZË TEL KS DYSHE 2x RJ11 6/4	203
KE39--	PRIZË CAT5e KS DYSHE 2x RJ45 8/8	203
KE41--	PRIZË CAT6s KS DYSHE 2x RJ45 8/8 SLIM	203
KE35--	PRIZË TEL LT RJ11 6/4	203

kodi	Përshkrimi i produktit	faqe
------	------------------------	------

KAPAKËT PE

PE10--	KAPAK TV-R 2P/3P	204
PE20--	KAPAK KS NJËSH	204
PE21--	KAPAK KS DYSH	204
PE30--	KAPAK TAE/TDO	204
PE32--	KAPAK ÇELËS IR	204

LIDHJET ELEKTRONIKE EE

EE15	REOSTAT RROTULLUES ME 2 DREJTME 400 W	205
EE16	REOSTAT RROTULLUES ME 2 DREJTME RLC 400 W	205
EE19	REOSTAT RROTULLUES ME 2 DREJTME LED 100 W	206
EE15--	REOSTAT RROTULLUES 2 DREJTME 400 W	206
EE16--	REOSTAT RROTULLUES ME 2 DREJTME RLC 400 W	207
EE19--	REOSTAT RROTULLUES ME 2 DREJTME LED 100 W	207
EE32--	ÇELËS IR 5A 230 V~	207

KAPAK ELEKTRONIK PE

PE41--	REOSTAT ME KAPAK Ø6	209
--------	---------------------	-----

AKSESORËT AE

AE10--	FALSO	210
AE20--	KUTI LIDHJEJE 5 POLARE 3P+N+E 5x4 mm2	210
AE30--	KUTI ME MONTIM NË SIPËRFAQE 1	210
AE31--	KUTI SIPËRFAQËSORE PËR PRIZË DYSHE EKONOMIK	210
AE50--	MBROJTJE PËR MUR	211
AE51--	MBROJTJE PËR FËMIJËT KS	211

RRETHUESE OE

OE10--	RRETHUES EKONOMIK 207	212
OE20--	RRETHUES EKONOMIK 2 HORIZONTAL	212
OE21--	RRETHUES EKONOMIK 2 VERTIKAL	212
OE30--	RRETHUES EKONOMIK 3 HORIZONTAL	212
OE31--	RRETHUES EKONOMIK 3 VERTIKAL	213
OE40--	RRETHUES EKONOMIK 4 HORIZONTAL	213
OE41--	RRETHUES EKONOMIK 4 VERTIKAL	213
OE50--	RRETHUES EKONOMIK 5 HORIZONTAL	213
OE90--	KORNIZA DEKORATIVE ME NGJYRA /	214

fontana

kodi	Përshkrimi i produktit	faqe
------	------------------------	------

ÇELËSAT SF

SF10--	ÇELËS ME 1 DREJTIM IP44 10 A X 250 V~	218
SF10--TI	ÇELËS ME 1 DREJTIM IP44 10 A X 250 V~ TI	218
SF11--TI	BUTON ME SHTYPJE ME 1 DREJTIM IP44 10 A 250 V~ TI	218
SF20--	ÇELËS 2 POLAR IP44 10 A X 250 V~	218
SF50--	ÇELËS ME 2 POZICIONE ME 1 DREJTIM IP44 10 A X 250 V~	219
SF51--	BUTON ME SHTYPJE ME 2 POZICIONE ME 1 DREJTIM IP44 10 A 250 V~	219
SF60--	ÇELËS ME 2 DREJTME IP44 10 A X 250 V~	219
SF60--TI	ÇELËS ME 1 DREJTIM IP44 10 A X 250 V~ TI	219
SF63--	ÇELËS DYSH ME 2 DREJTME 10 A X 250 V~	219
SF70--	ÇELËS NDËRMJETËS IP44 10 A X 250 V~	219

PRIZAT VF

VF10--	PRIZË SCHUKO+KAPAK IP44 2P+E 16 A 250 V~	220
VE12--	PRIZË SCHUKO+KAPAK IP44 2P+E 16 A 250 V~ BV	220

SETET CF

CF10--	SET PRIZË SCHUKO DYSHE HORIZONTALE IP44 2x 2P+E 16 A 250 V~	221
CF11--	SET PRIZË SCHUKO DYSHE VERTIKALE IP44 2x 2P+E 16 A 250 V~	221
CF12--	PRIZË SCH+SET ÇELËS 2 DREJTME HORIZONTAL IP44 16 A + 10 A X 250 V~	221
CF13--	PRIZË SCH+SET ÇELËS 2 DREJTME VERTIKAL IP44 16 A + 10 A X 250 V~	222
CF14--	SET PRIZË SCHUKO DYSHE HORIZONTALE IP44 2x 2P+E 16 A 250 V~ BV	222
CF15--	SET PRIZË SCHUKO DYSHE VERTIKALE IP44 2x 2P+E 16 A 250 V~ BV	222
CF16--	PRIZË SCH+SET ÇELËS ME 2 DREJTME HORIZONTALE IP44 16 A + 10 A X 250 V~ BV	222
CF17--	PRIZË SCH+SET ÇELËS ME 2 DREJTME VERTIKALE IP44 16 A + 10 A X 250 V~ BV	222

AKSESORËT AF

AF10--	KUTI SHPËRNDARJEJE IP44 RN01	223
AF20--	KUTI SHPËRNDARJEJE IP55 ND01	223

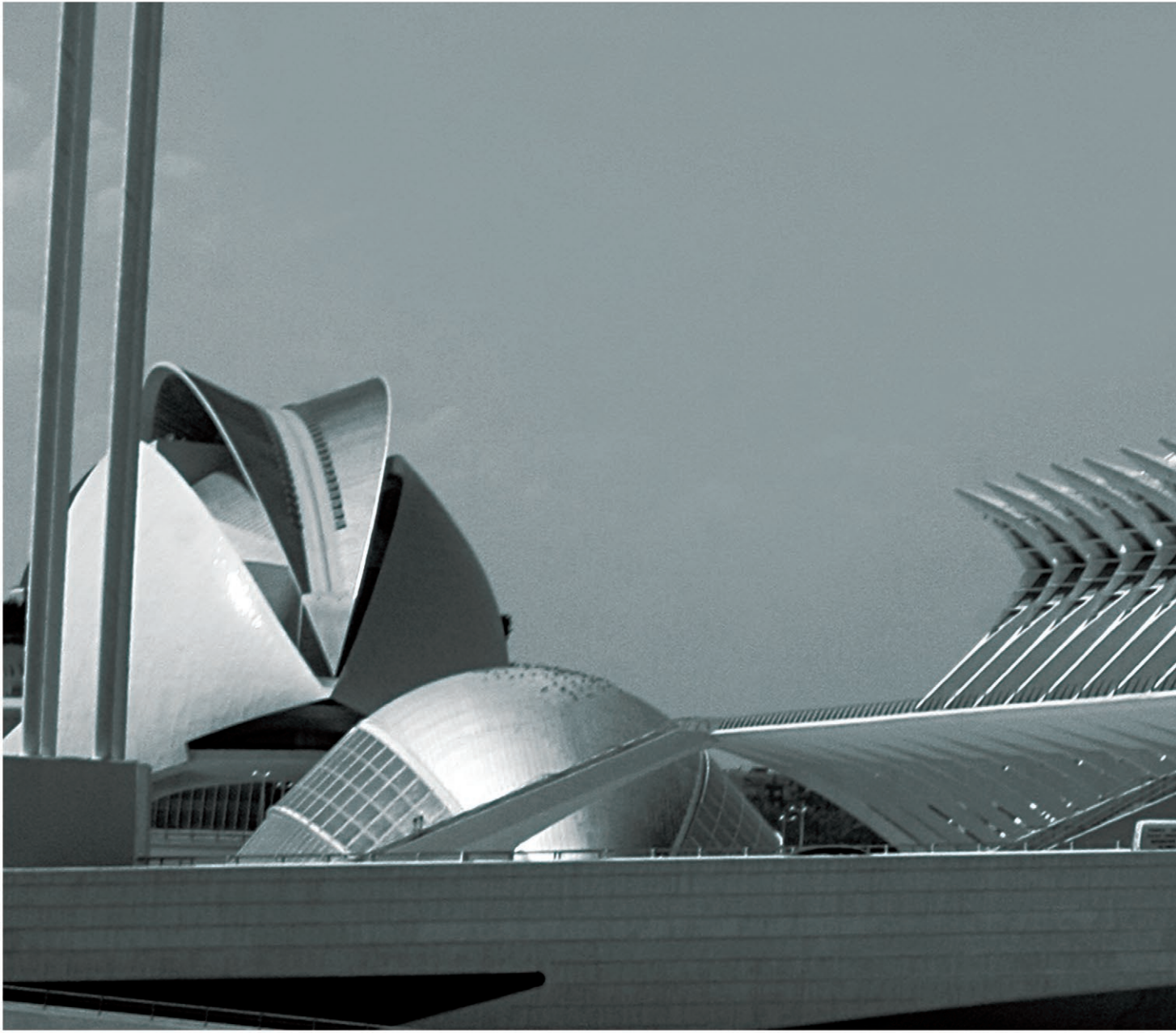

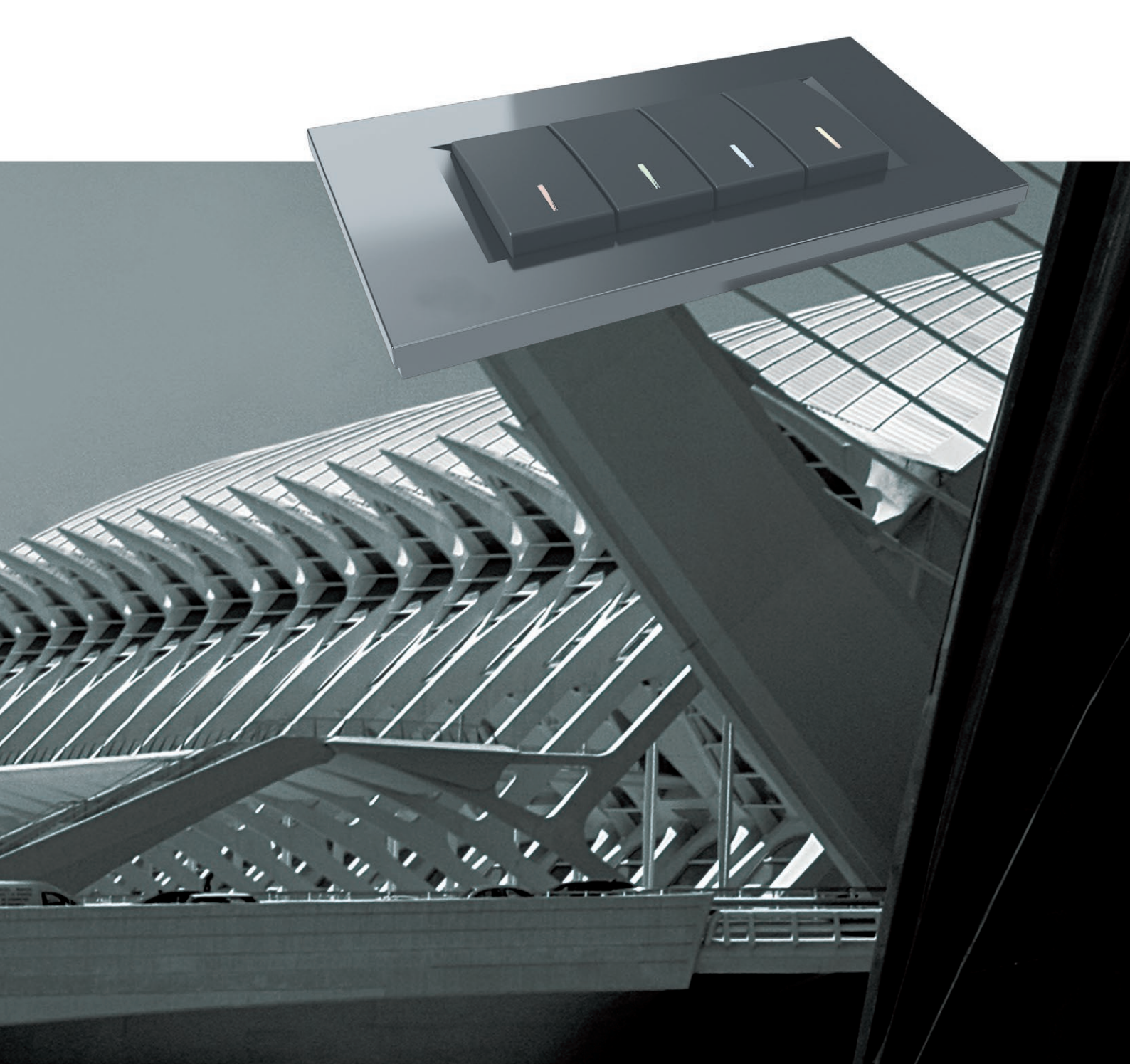

TEM

TEM ČATEŽ d.o.o.
Čatež 13, 8212 VELIKA LOKA
SLOVENIJA
tem@tem.si
www.tem.si
T +386(0)7 348 99 00



AL