

TEM

On | Off and everything in between



2023

MODUL



MODUL
LINE



MODUL
SOFT



MODUL
PURE

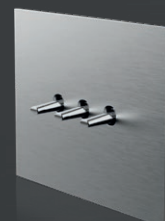

MODUL
EDGE

50

LOGIQ



162

ekonomik



192

fontana



230



TEM

On | Off and everything in between



Ние сме водещият производител на ключове и контакти в региона. Вече половин век ние предоставяме на нашите потребители позитивна и лесна практическа работа, лесен монтаж и използване на продуктите, широка гама от цветове и материали, които убеждават дори най-взискателните.

We are the leading manufacturer of switches and sockets in the region. For half a century, we have been providing our users a positive and easy experience, simple installation and use of products, a wide range of colours and materials, which convince even the most demanding.

TEM

Добре дошли в семейството MODUL
Welcome to the MODUL family

Добавете лична нотка към атмосферата си и покажете
стила си с ключове и контакти от семейството MODUL.

*Give your ambience a personal touch and show off your style with
switches and sockets from MODUL family.*

откриване на нови прозрения
discovering new insights



MODUL

LINE



MODUL

SOFT



MODUL

PURE



MODUL

EDGE

MODUL

Изберете своя
ДИЗАЙН
Select your DESIGN

Изберете своя
ЦВЯТ
Select your COLOUR

1

2

MODUL

LINE



MODUL

SOFT



MODUL

PURE

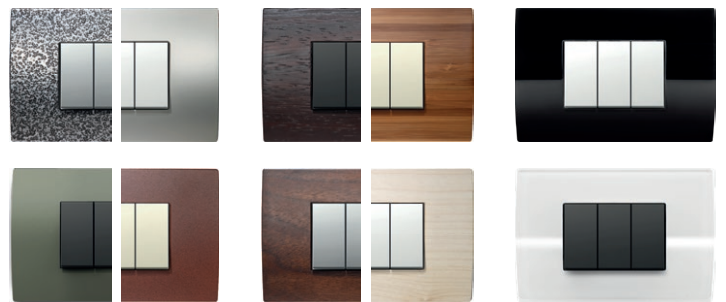

метал

дърво

стъкло

3



4

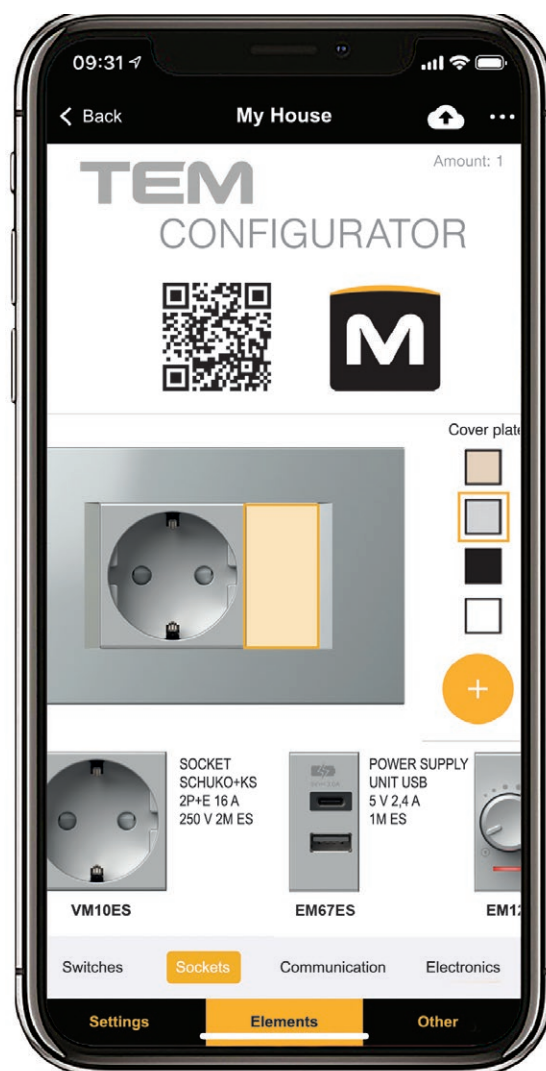

MODUL

LINE



Правите, плавни линии създават дизайн, неподвластен на времето.

Straight, smooth lines create a timeless design.





MODUL

LINE

PW

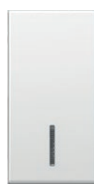

полярно бяло

polar white

MW



Бял матов цвят

matte white

IW



слонова кост

ivory white

ES



елоксирано
сребро

elox silver

AT



антрацит

anthracite

SB

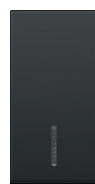

меко черно

*soft touch
black*

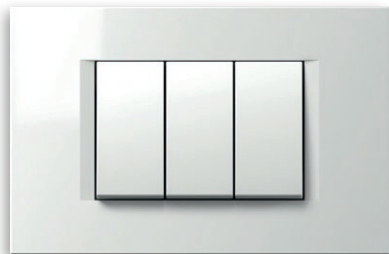

PW полярно бяло
polar white

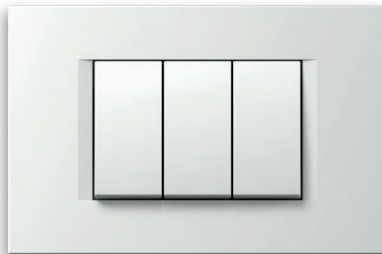

MW Бял матов цвят
matte white

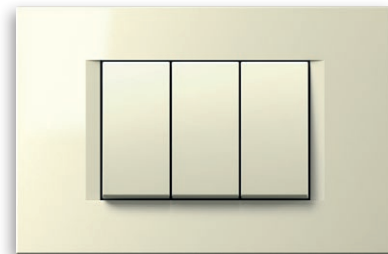

IW слонова кост
ivory white



SW каменно бяло
stone white



ES елоксирано сребро
elox silver

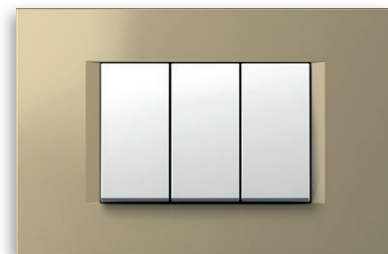

SG пясъчно злато
sand gold



TI титан
titanium

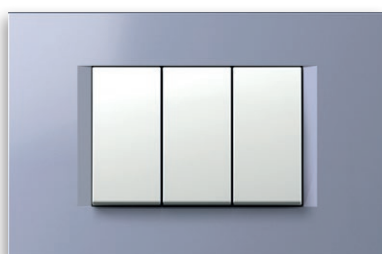

IB импулсивно синьо
impulse blue



AT антрацит
anthracite



NB нощно черно
night black



SB меко черно
soft touch black

MODUL

SOFT

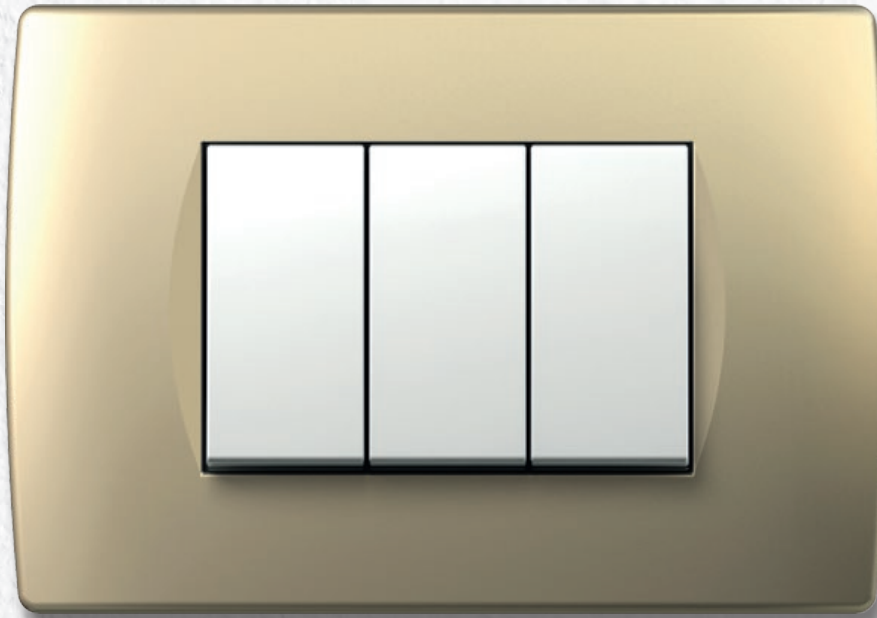

Заоблените форми и леките преходи внасят мекота във вашия дом.

Rounded shapes and soft transitions bring softness into your home.





MODUL

SOFT

PW



полярно бяло

polar white

MW



Бял матов цвят

matte white

IW



слонова кост

ivory white

ES



елоксирано
сребро

elox silver

AT

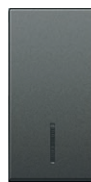

антрацит

anthracite

SB



меко черно

*soft touch
black*

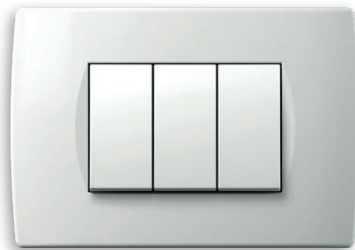

PW полярно бяло
polar white

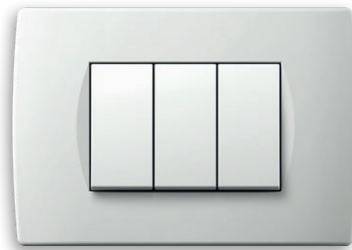

MW Бял матов цвят
matte white

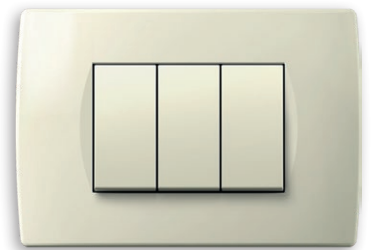

IW слонова кост
ivory white



ES елоксирано сребро
elox silver

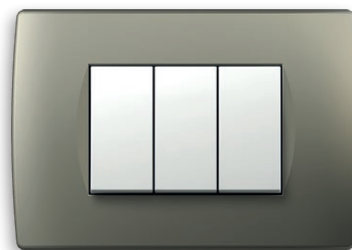

TI титан
titanium

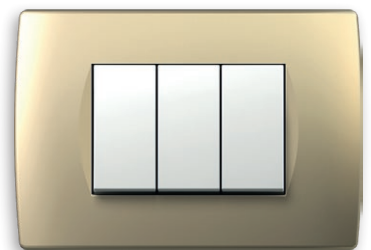

SG пясъчно злато
sand gold



WW титан
walnut



WE венге
wenge



AT антрацит
anthracite



NB нощно черно
night black



SB меко черно
soft touch black

MODUL

PURE

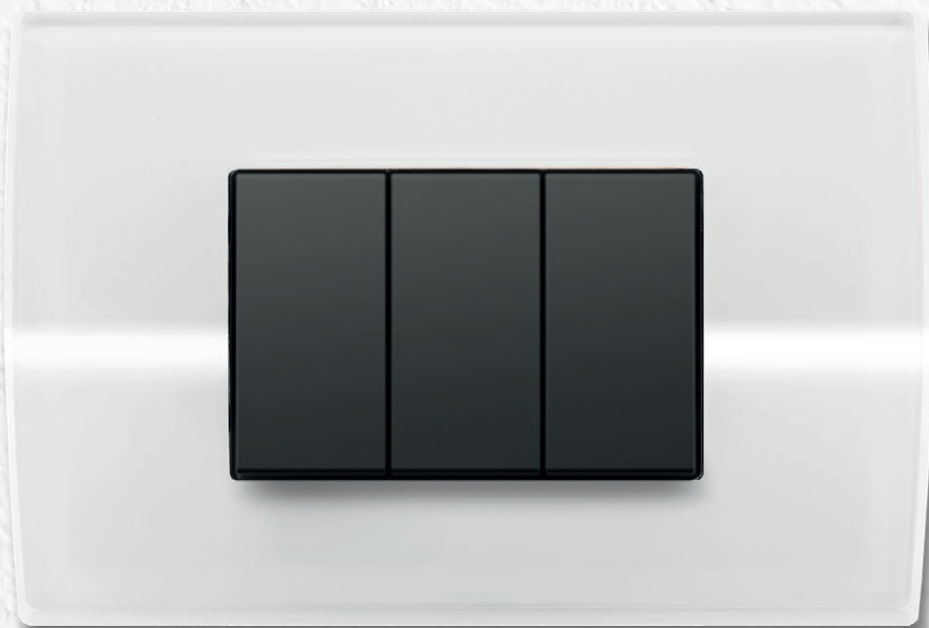

Детайлите представляват завършеността на цялата атмосфера. Оставете природата да обогати пространството ви с декоративни панели, изработени от дърво, стъкло и метал.

The details represent the completeness of the entire ambience. Let the nature enrich your space with decorative cover plates made of wood, glass and metal.





MODUL

PURE

PW

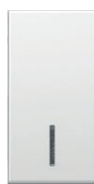

полярно бяло

polar white

MW

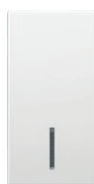

Бял матов цвят

matte white

IW



слонова кост

ivory white

ES



елоксирано
сребро

elox silver

AT



антрацит

anthracite

SB

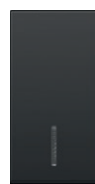

меко черно

*soft touch
black*

СТЪКЛО
glass



GL бяло
glass light

МЕТАЛ
metal



MH кована стомана
hammered steel

ДЪРВО
wood



WM клен
maple

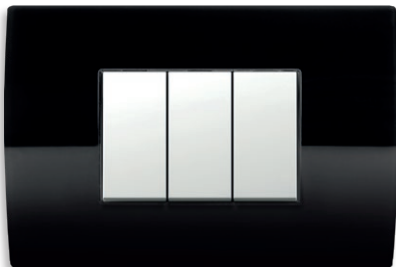

GD черно
glass dark

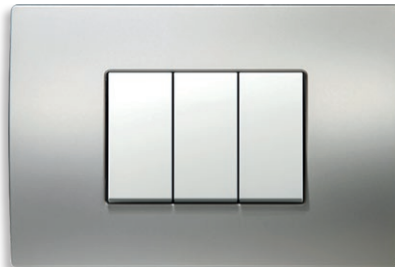

MS сатенирано сребро
satın silver



WB бамбук
bamboo



MN сатениран никел
satın nickel



WW орех
walnut



ME гравирано желязо
etched iron



WE венге
wenge

MODUL

PURE



СТЪКЛО – леко и изискано.
Оставете свежестта да навлезе в дома ви.

*GLASS - light and sophisticated.
Let freshness breeze through your home.*



СТЪКЛО
glass

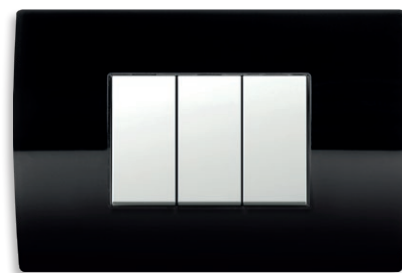

MODUL

PURE



МЕТАЛ – студено, но благородно.
Прегърнете този изчистен материал и
привличайте неусетно вниманието.

METAL - cold, yet noble.

*Embrace this pristine material and
effortlessly catch attention.*





метал
metal

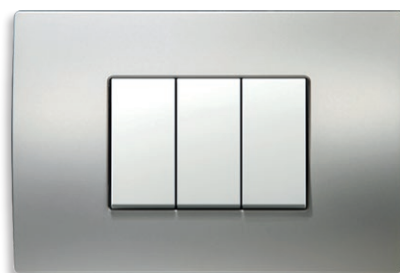

MODUL

PURE



ДЪРВО – универсално, но същевременно
уникално.
Отстъпете място за топлината на природата.

*WOOD - versatile, yet unique.
Give way to nature's warmth.*





дърво
wood



MODUL

EDGE

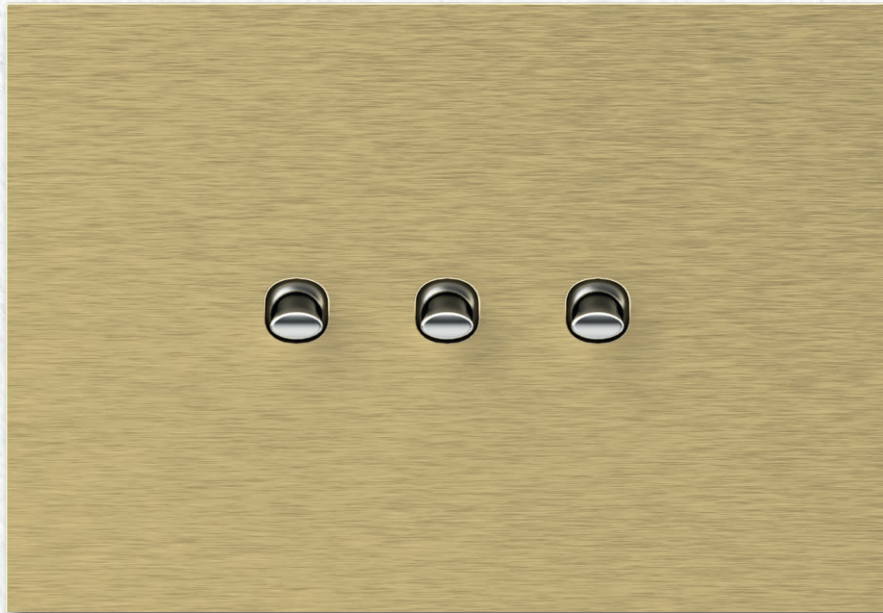

Нова престижна линия, осигуряваща специален сетивен и визуален опит, както никога досега.

The new prestigious product line offers a special sensory and visual experience like no other before. Are you bold enough?





MODUL

EDGE

PB



черно

black

PA



антрацит

anthracite

PG



злато

gold

PC



хром

chrome

метал
metal

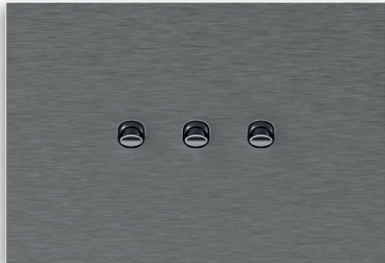

MA сребро
silver

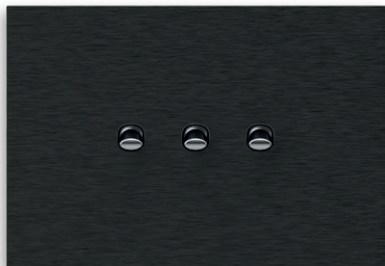

MT антрацит
anthracite

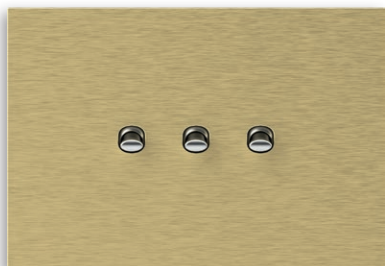

MZ злато
gold

СТЪКЛО
glass



GL бяло
glass light



GD черно
glass dark

MODUL

EDGE



Чистотата на стъклото позволява на светлината да си играе и да се проявява в новите стъклени декоративни рамки EDGE. Контрастните цветове удовлетворяват и най-изтъчения вкус.

The purity of the glass allows the light to playfully manifest in the new EDGE glass decorative cover plates. The two contrast colours satisfy even the most sophisticated taste.





СТЪКЛО
glass



GL бяло
glass light



GD черно
glass dark

MODUL
EDGE



Благодарение на впечатляващата обработка, алуминият грейва в нова светлина – на металните декоративни рамки EDGE. В три цветови гами, заслужаващи внимание.

Thanks to the impressive treatment, the aluminium shines with a new light – EDGE metal decorative cover plates. The three colours are worthy of your attention.





метал
metal

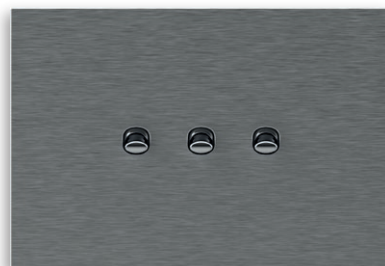

MA сребро
silver



MT антрацит
anthracite

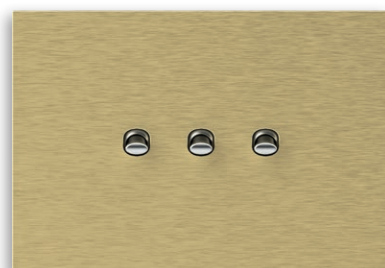

MZ злато
gold

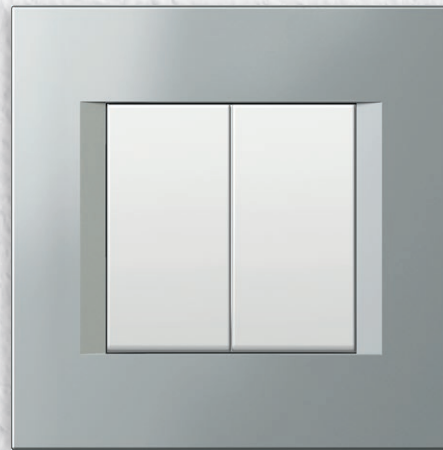

MODUL

- LINE
- SOFT
- PURE
- EDGE

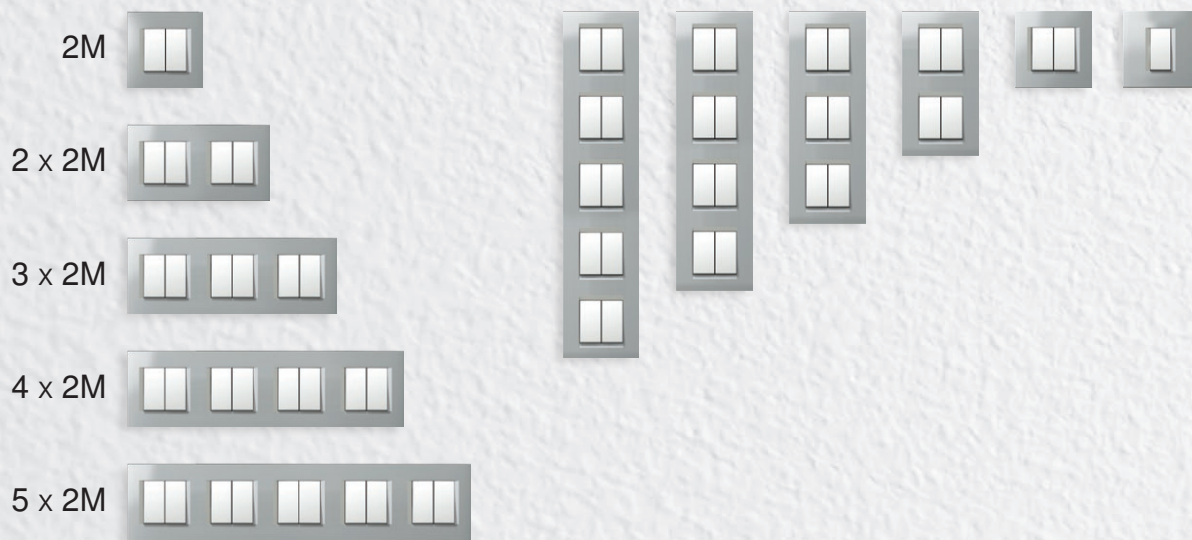
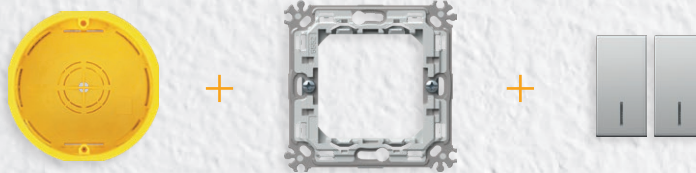

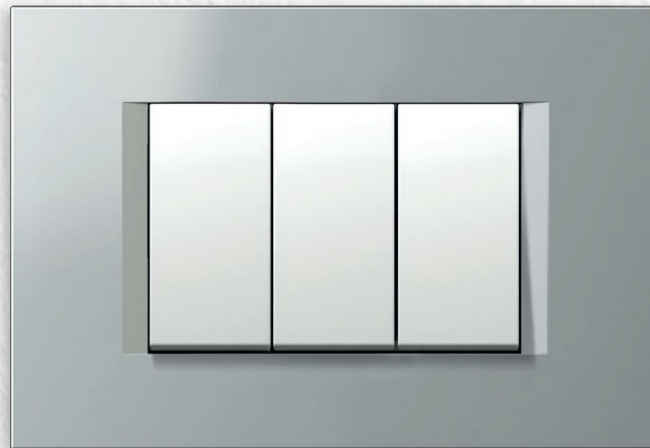

MODUL

- LINE
- SOFT
- PURE
- EDGE



2 x 7M

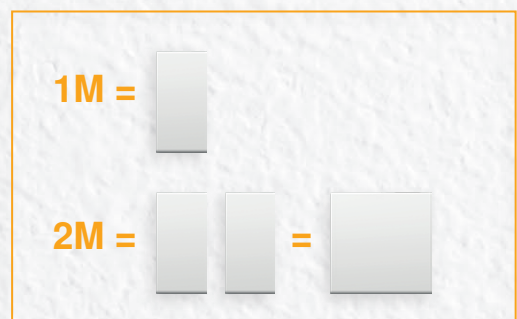
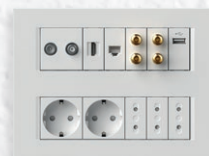

Функционалните елементи се монтират лесно в монтажната рамка.

Решението „щракване за поставяне, щракване за изваждане“, което сме разработили за вас, намалява времето за монтиране. Достъпът до контактите за съединяване е лесен откъм предната страна.

The function elements are easily fitted inside the mounting frame.

The “klik-in, klik-out” solution we have developed for you will reduce installation time. The connection contacts are easily accessible from the front.

klik-in, klik-out

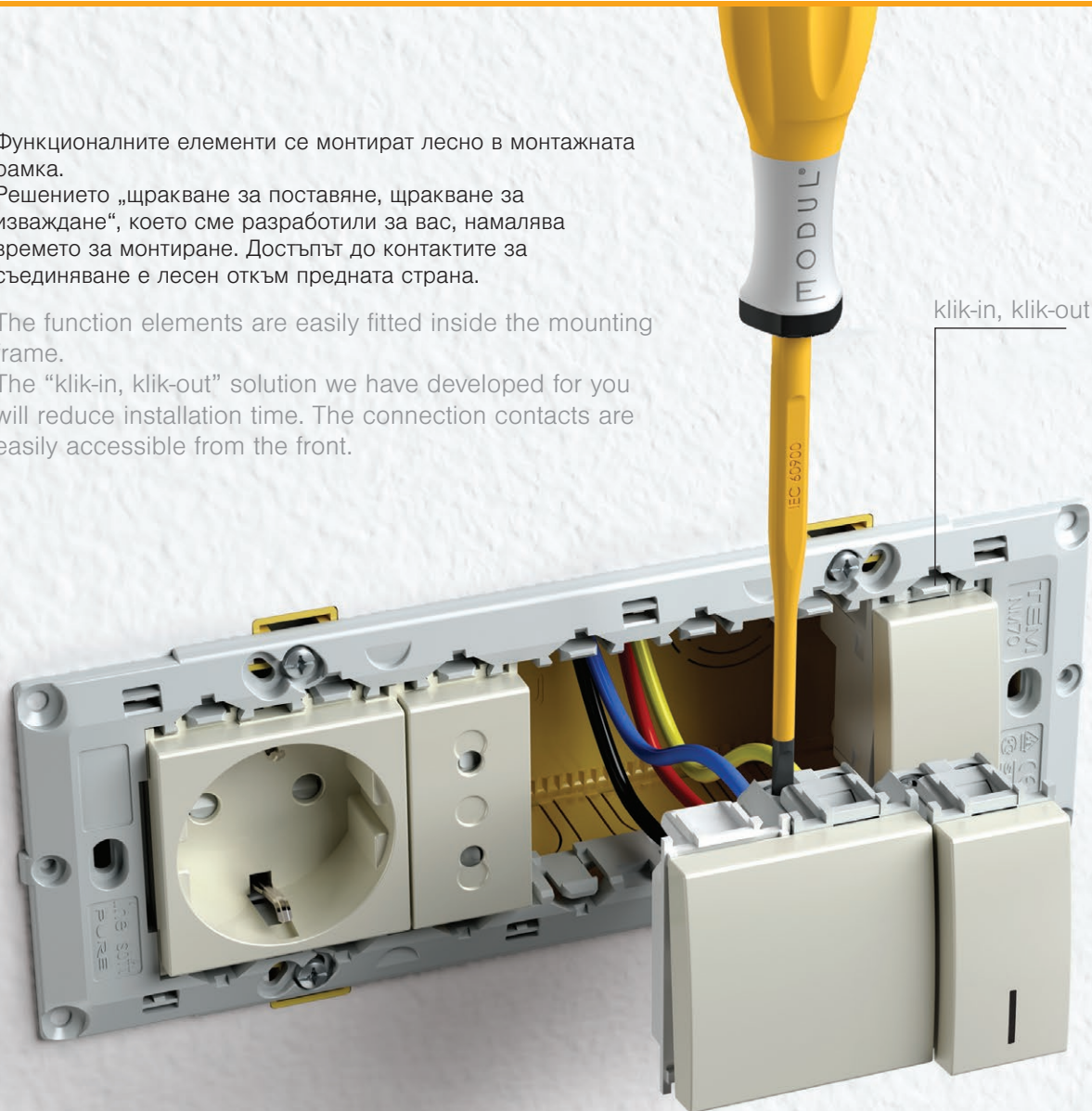

Modul е подходящ за всички видове стени и може да се използва в обикновени конструкции, както и за кухи стени или бетон. Инсталирането е лесно и ви дава възможност лесно да инсталирате и комбинирате правилните разстояния за правоъгълни и кръгли конзоли. Използваните материали отговарят на високи стандарти.

The Modul is suitable for all wall types and can be used in conventional, hollow wall or concrete constructions. It is easy to install and enables you to combine rectangular or round boxes at the proper distances. The materials used are compliant with high standards.



тухла / brick



куха стена / hollow wall



бетон / concrete

Modul предоставя голям брой възможности даже с кръгли конзоли. Можете да ги комбинирате хоризонтално или вертикално, самостоятелно или във вид на групи. Металната монтажна рамка гарантира отлична стабилност дори при работа с кръгли елементи и е подходяща за всякакви декоративни панели.

The Modul enables a many possibilities even with round boxes. You can combine them horizontally or vertically, individually or in groups. The metal mounting frame ensures excellent stability even with rough use and is suitable for any decorative cover plates.

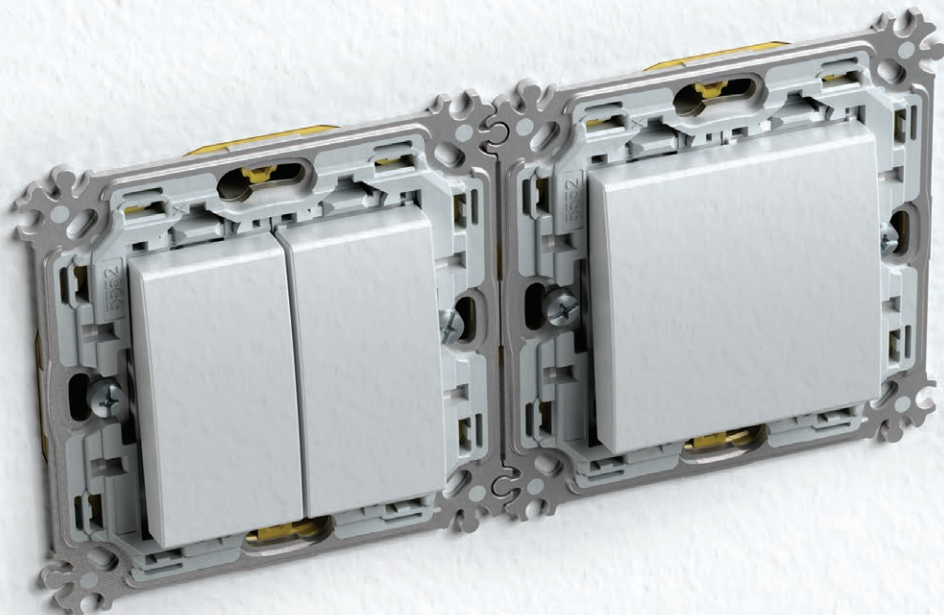



□ PW
полярно бяло
polar white



□ MW
Бял матов цвят
matte white



■ SB
меко черно
soft touch black



■ AT
антрацит
anthracite



□ ES
елоксирано сребро
elox silver



□ IW
слонова кост
ivory white

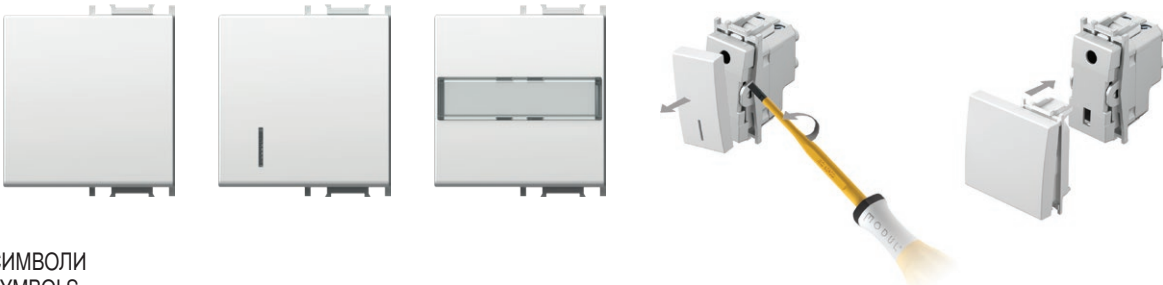

СИМВОЛИ
SYMBOLS

01	02	03	04	05	06	07	08	09	10	11	12	13	14	20	21
													1 0 2	+	-
22	23	24	25	26	27	28	29	30	31	32	33	34	35	36	37
					alarm	alarm	OFF	ON	+				AC		
38	39	40	41	42	43	44	45	46	47	48					

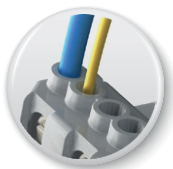
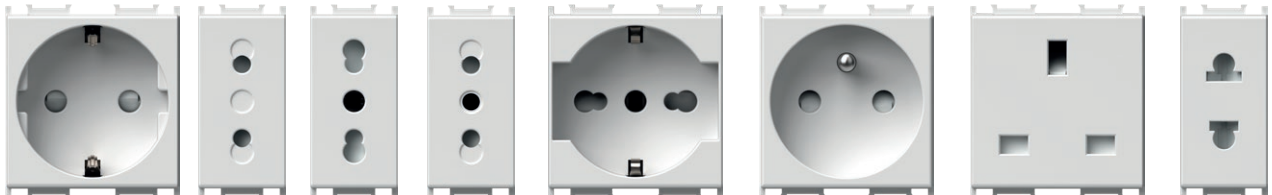

Надежно свързване, дори при използване на проводници с различно сечение.

Reliable connection even when different size of wires are used.



Всички контакти са оборудвани за безопасно изключване, което гарантира защитата на контактите, които са под напрежение.

All the sockets are equipped with a safety shutters assuring the protection to live contacts.

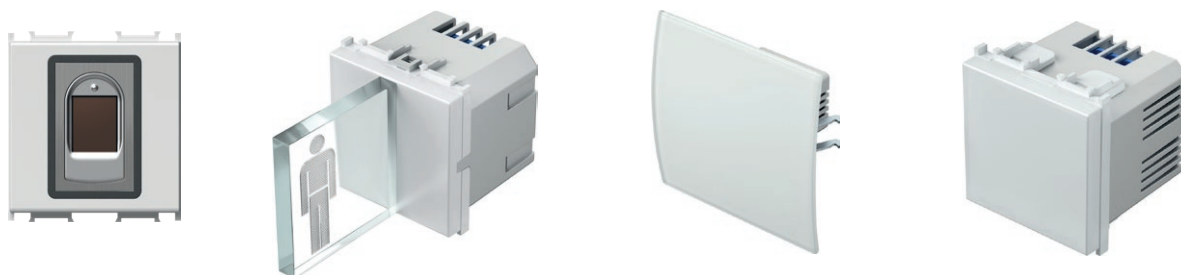
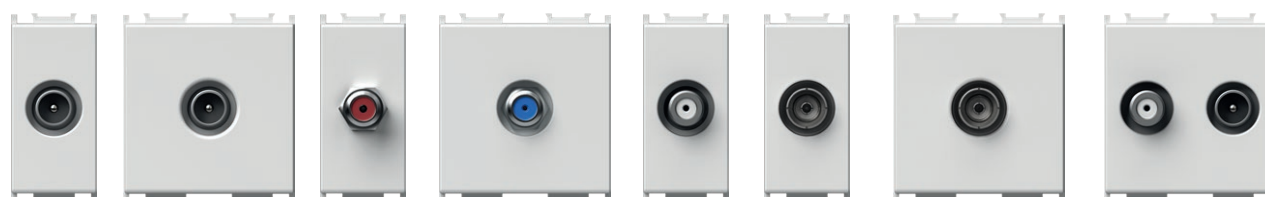
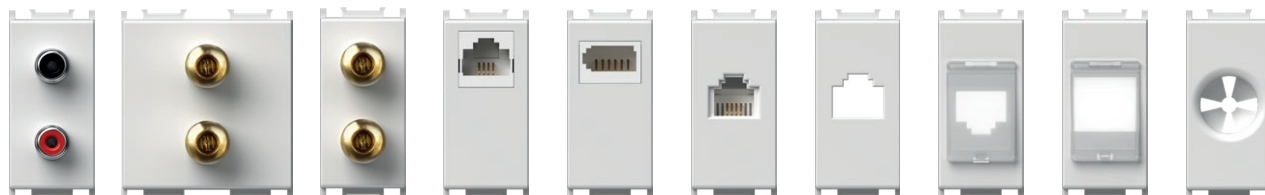

Дълъг експлоатационен живот на ключовете и съответствие с изискванията на международните стандарти.

Long-life of switches and adequacy to the international standards.



Ключът е с висока надеждност, благодарение на своите контакти със сребърни нитове.

The switch is highly reliable via its silver rivets contacts.

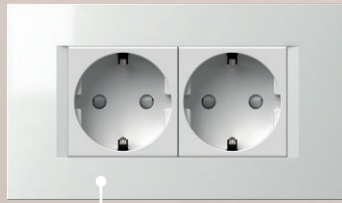
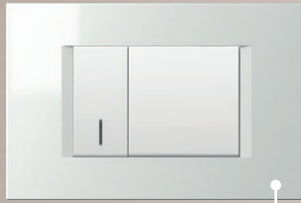



BIOPASS – ключ с четец за пръстов отпечатък
BIOPASS - fingerprint switch

Отключване без ключ.
Keyless unlocking.

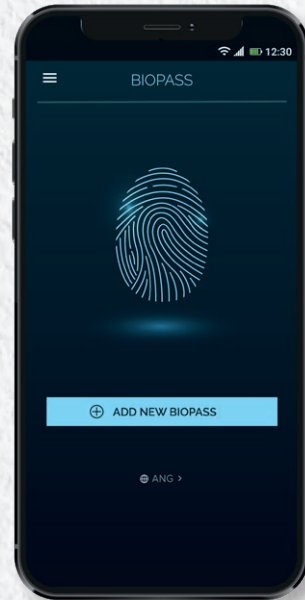

МУЛТИМЕДИЯ

MULTIMEDIA

Мултимедиен център, който ви дава възможност да свързвате няколко компонента на едно място.
Multimedia center that allows you to connect a multiple number of components in one place.



НАПРАВЕТЕ ГО УНИКАЛНО

MAKE IT UNIQUE

Изберете цвета на осветлението и добавете желаната графика, която ще подхожда на атмосферата на вашата стая.

Choose a illumination colour and add desired graphic to suit the ambience of your room.



СЪЗДАЙТЕ СВОЙ СОБСТВЕН
CREATE YOUR OWN

Когато поръчвате големи количества, декоративните панели и функционалните елементи могат да бъдат изработени в изборния от вас цвят.

When ordering large quantities, cover plates and function elements can be made in the colour of your choice.





МУЛТИФУНКЦИОНАЛЕН ВРЕМЕВИ КЛЮЧ

MULTIPURPOSE TIMER SWITCH

4 в 1

- таймер
- реле
- БУТОН
- Ключ

4 in 1

- *timer*
- *relay*
- *push button*
- *switch*



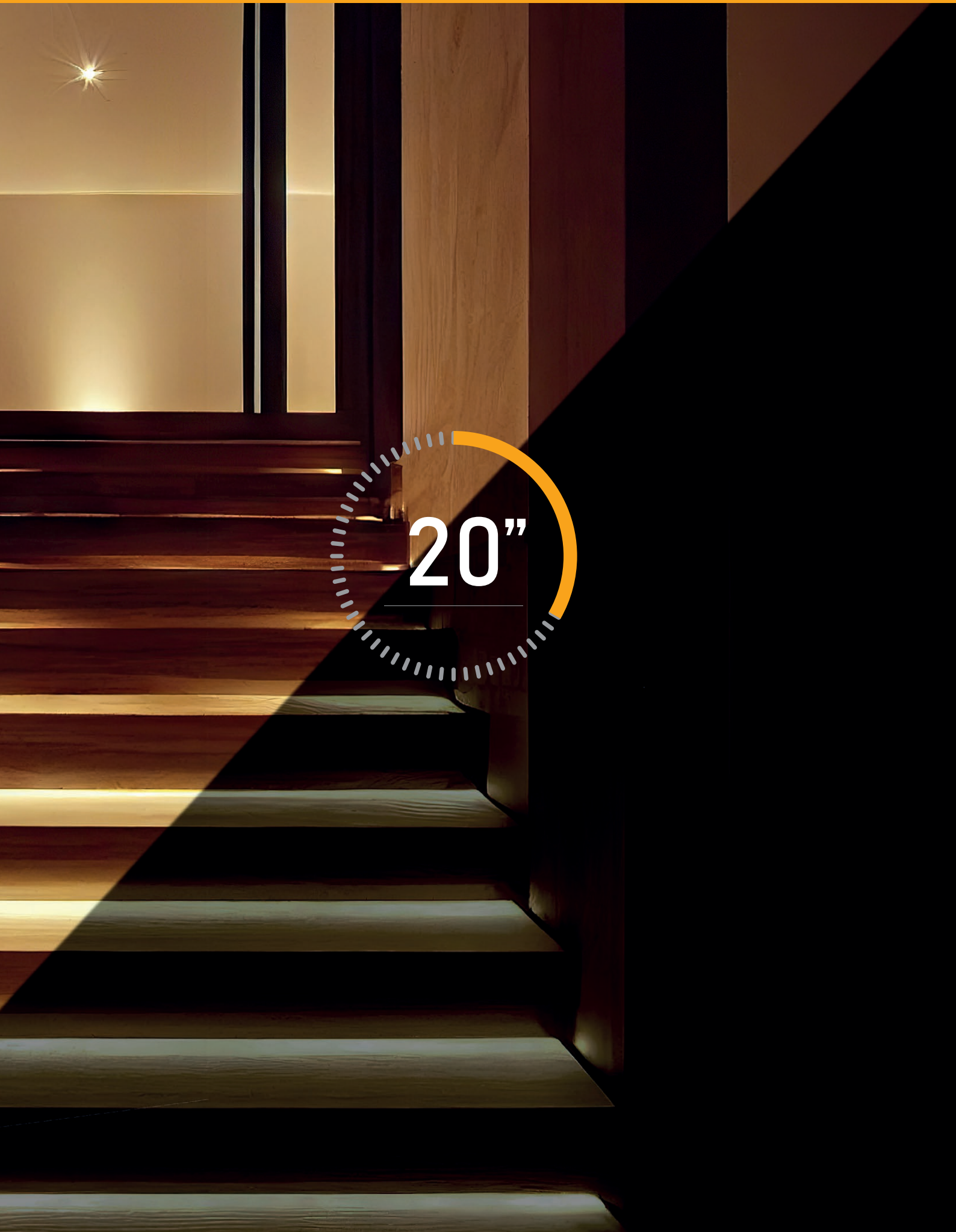

20"

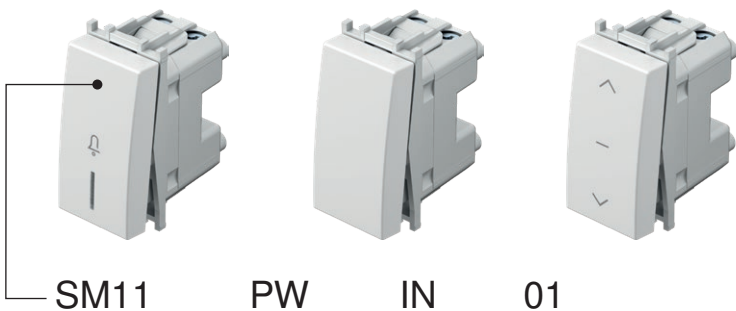

тип type	описание description	технически данни technical data	размер size	цвет colour	допълнителна информация 1 optional data 1	допълнителна информация 2 optional data 2
SM10	КЛЮЧ 1WAY SWITCH 1WAY	16AX 250V~	1M	□ PW снежнобял цвят polar white	NT неутрален neutral	🔔 01
SM11	БУТОН 1WAY PUSH BUTTON 1WAY	16A 250V~	1M	□ MW Бял матов цвят matte white	IN индикатор indicator	🔦 02
SM12	КЛЮЧ 1WAY SWITCH 1WAY	20A 250V~	1M	■ SB сензорен бутон черен soft touch black		0 03
⋮	⋮	⋮	⋮	■ AT антрацит anthracite		
⋮	⋮	⋮	⋮	■ ES сребрист elox silver		
				■ IW слоновя кост ivory white		

КЛЮЧ 1WAY 16AX 250V~ 1M



SM10



- ключ без бутон
 - 16 AX 250 V~, тип SM10
 - в съответствие с EN 60669-1
 - винтови контакти 1,5 - 2,5 mm²
- SWITCH 1WAY 16AX 250V~ 1M**
- switch without button
 - 16AX 250V~, type SM10
 - in accordance with EN 60669-1
 - screw contacts 1.5-2.5mm²

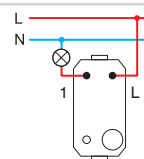

БУТОН 1WAY 16A 250V~ 1M



SM11



- бутон без клавиш за натискане
 - 16 A 250 V~, тип SM11
 - в съответствие с EN 60669-1
 - винтови контакти 1,5 - 2,5 mm²
- PUSH BUTTON 1WAY 16A 250V~ 1M**
- push button without button
 - 16A 250V~, type SM11
 - in accordance with EN 60669-1
 - screw contacts 1.5-2.5mm²

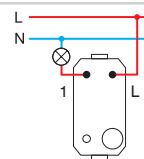

КЛЮЧ 1WAY 20A 250V~ 1M



SM12



- ключ без бутон
 - 20 A 250 V~, тип SM12
 - в съответствие с EN 60669-1
 - винтови контакти 1,5 - 2,5 mm²
- SWITCH 1WAY 20A 250V~ 1M**
- switch without button
 - 20A 250V~, type SM12
 - in accordance with EN 60669-1
 - screw contacts 1.5-2.5mm²

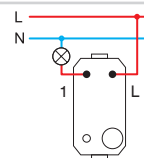

КЛЮЧ 2POLE 16AX 250V~ 1M



SM20

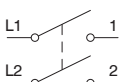

- ключ без бутон
 - 16 AX 250 V~, тип SM20
 - в съответствие с EN 60669-1
 - винтови контакти 1,5 - 2,5 mm²
 - само в комбинация с бутон TM15
- SWITCH 2POLE 16AX 250V~ 1M**
- switch without button
 - 16AX 250V~, type SM20
 - in accordance with EN 60669-1
 - screw contacts 1.5-2.5mm²
 - only in combination with button TM15

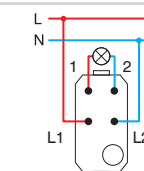

S W I T C H E S S M



SM40

КЛЮЧ ЗА ЩОРИ 1-0-2 16AX 250V~ 1M

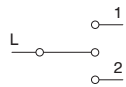

- ключ без бутон
 - 16 AX 250 V~, тип SM40
 - в съответствие с EN 60669-1
 - винтови контакти 1,5 - 2,5 mm²
- SWITCH SHUTTERS 1-0-2 16AX 250V~ 1M**
- switch without button
 - 16AX 250V~, type SM40
 - in accordance with EN 60669-1
 - screw contacts 1.5-2.5mm²

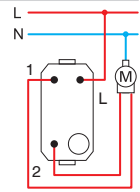

SM41

КЛЮЧ ЗА ЩОРИ 1-0-2 16A 250V~ 1M

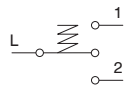

- бутон без клавиш за натискане
 - 16 A 250 V~, тип SM41
 - в съответствие с EN 60669-1
 - винтови контакти 1,5 - 2,5 mm²
- PUSH BUTTON SHUTTERS 1-0-2 16A 250V~ 1M**
- push button without button
 - 16A 250V~, type SM41
 - in accordance with EN 60669-1
 - screw contacts 1.5-2.5mm²

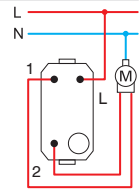

SM60

КЛЮЧ 2WAY 16AX 250V~ 1M

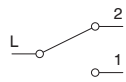

- ключ без бутон
 - 16 AX 250 V~, тип SM60
 - в съответствие с EN 60669-1
 - винтови контакти 1,5 - 2,5 mm²
- SWITCH 2WAY 16AX 250V~ 1M**
- switch without button
 - 16AX 250V~, type SM60
 - in accordance with EN 60669-1
 - screw contacts 1.5-2.5mm²

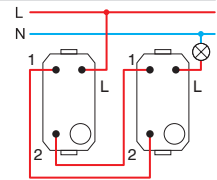

SM61

БУТОН 2WAY 16A 250V~ 1M

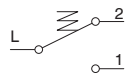

- бутон без клавиш за натискане
 - 16 A 250 V~, тип SM61
 - в съответствие с EN 60669-1
 - винтови контакти 1,5 - 2,5 mm²
- PUSH BUTTON 2WAY 16A 250V~ 1M**
- push button without button
 - 16A 250V~, type SM61
 - in accordance with EN 60669-1
 - screw contacts 1.5-2.5mm²

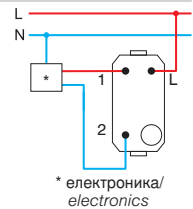

SM70

КРЪСТАТ КЛЮЧ 16AX 250V~ 1M

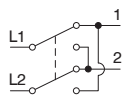

- ключ без бутон
 - 16 AX 250 V~, тип SM70
 - в съответствие с EN 60669-1
 - винтови контакти 1,5 - 2,5 mm²
- SWITCH INTERMEDIATE 16AX 250V~ 1M**
- switch without button
 - 16AX 250V~, type SM70
 - in accordance with EN 60669-1
 - screw contacts 1.5-2.5mm²

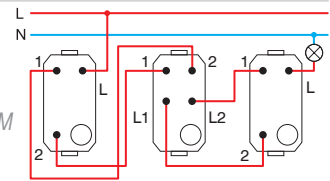

1M = 22,5 x 45
2M = 45 x 45

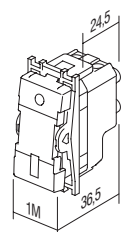
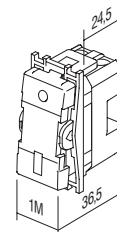



PW снежнобял цвят
polar white



SB сензорен бутон черен
soft touch black



AT антрацит
anthracite



ES сребрист
elox silver



IW слонова кост
ivory white

MW Бял матов цвят
matte white

КЛЮЧ 1WAY 16AX 250V~ 1M



- SM10PW
- SM10MW
- SM10SB
- SM10AT
- SM10ES
- SM10IW

- 16 AX 250 V~, тип SM10
- в съответствие с EN 60669-1
- винтови контакти 1,5 - 2,5 mm²
- сменяем бутон

SWITCH 1WAY 16AX 250V~ 1M
- 16AX 250V~, type SM10
- in accordance with EN 60669-1
- screw contacts 1.5-2.5 mm²
- replaceable button



КЛЮЧ 1WAY 16AX 250V~ 1M __ IN



- SM10PWIN
- SM10MWIN
- SM10SBIN
- SM10ATIN
- SM10ESIN
- SM10IWIN

- IN индикатор
- 16 AX 250 V~, тип SM10
- в съответствие с EN 60669-1
- винтови контакти 1,5 - 2,5 mm²
- лампата не е включена в доставката
- сменяем бутон

SWITCH 1WAY 16AX 250V~ 1M __ IN
- IN indicator
- 16AX 250V~, type SM10
- in accordance with EN 60669-1
- screw contacts 1.5-2.5 mm²
- lamp is not included
- replaceable button



БУТОН 1WAY 16A 250V~ 1M

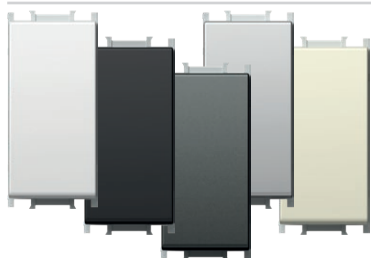

- SM11PW
- SM11MW
- SM11SB
- SM11AT
- SM11ES
- SM11IW

- 16 A 250 V~, тип SM11
- в съответствие с EN 60669-1
- винтови контакти 1,5 - 2,5 mm²
- сменяем бутон

PUSH BUTTON 1WAY 16A 250V~ 1M
- 16A 250V~, type SM11
- in accordance with EN 60669-1
- screw contacts 1.5-2.5 mm²
- replaceable button



БУТОН 1WAY 16A 250V~ 1M __ IN 01



- SM11PWIN01
- SM11MWIN01
- SM11SBIN01
- SM11ATIN01
- SM11ESIN01
- SM11IWIN01

- IN 01 звънчев индикатор
- 16 A 250 V~, тип SM11
- в съответствие с EN 60669-1
- винтови контакти 1,5 - 2,5 mm²
- лампата не е включена в доставката
- сменяем бутон

PUSH BUTTON 1WAY 16A 250V~ 1M __ IN 01
- IN 01 indicator bell
- 16A 250V~, type SM11
- in accordance with EN 60669-1
- screw contacts 1.5-2.5 mm²
- lamp is not included
- replaceable button



БУТОН 1WAY 16A 250V~ 1M __ IN 02



- SM11PWIN02 - IN 02 светлинен индикатор
- SM11MWIN02 - 16 A 250 V~, тип SM11
- SM11SBIN02 - в съответствие с EN 60669-1
- SM11ATIN02 - винтови контакти 1,5 - 2,5 mm²
- SM11ESIN02 - лампата не е включена в доставката
- SM11IWIN02 - сменяем бутон

PUSH BUTTON 1WAY 16A 250V~ 1M __ IN 02

- IN 02 indicator light
- 16A 250V~, type SM11
- in accordance with EN 60669-1
- screw contacts 1.5-2.5 mm²
- lamp is not included
- replaceable button



КЛЮЧ 2POLE 16AX 250V~ 1M __ NT 03



- SM20PWNT03 - NT 03 неутрален 0-1
- SM20MWNT03 - 16 AX 250 V~, тип SM20
- SM20SBNT03 - в съответствие с EN 60669-1
- SM20ATNT03 - винтови контакти 1,5 - 2,5 mm²
- SM20ESNT03 - сменяем бутон
- SM20IWNTO3

SWITCH 2POLE 16AX 250V~ 1M __ NT 03

- NT 03 neutral 0-1
- 16AX 250V~, type SM20
- in accordance with EN 60669-1
- screw contacts 1.5-2.5 mm²
- replaceable button



КЛЮЧ 2POLE 16AX 250V~ 1M __ IN



- SM20PWIN
- SM20MWIN
- SM20SBIN
- SM20ATIN
- SM20ESIN
- SM20IWIN

SWITCH 2POLE 16AX 250V~ 1M __ IN

- IN индикатор
- 16 AX 250 V~, тип SM20
- в съответствие с EN 60669-1
- винтови контакти 1,5 - 2,5 mm²
- лампата не е включена в доставката
- сменяем бутон



КЛЮЧ ЗА ЩОРИ 1-0-2 16AX 250V~ 1M __ NT 10

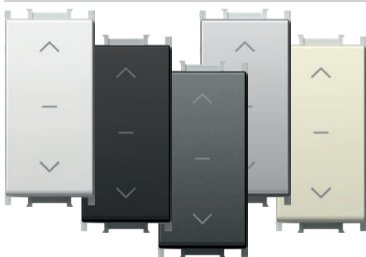

- SM40PWNT10 - NT 10 неутрален 1-0-2
- SM40MWNT10 - 16 AX 250 V~, тип SM40
- SM40SBNT10 - в съответствие с EN 60669-1
- SM40ATNT10 - винтови контакти 1,5 - 2,5 mm²
- SM40ESNT10 - сменяем бутон
- SM40IWNTO10

SWITCH SHUTTERS 1-0-2 16AX 250V~ 1M __ NT 10

- NT 10 neutral 1-0-2
- 16AX 250V~, type SM40
- in accordance with EN 60669-1
- screw contacts 1.5-2.5mm²
- replaceable button



БУТОНИ ЗА ЩОРИ 1-0-2 16A 250V~ 1M __ NT 10



- SM41PWNT10 - NT 10 неутрален 1-0-2
- SM41MWNT10 - 16 A 250 V~, тип SM41
- SM41SBNT10 - в съответствие с EN 60669-1
- SM41ATNT10 - винтови контакти 1,5 - 2,5 mm²
- SM41ESNT10 - сменяем бутон
- SM41IWNTO10

PUSH BUTTON SHUTTERS 1-0-2 16A 250V~ 1M __ NT 10

- NT 10 neutral 1-0-2
- 16A 250V~, type SM41
- in accordance with EN 60669-1
- screw contacts 1.5-2.5mm²
- replaceable button



КЛЮЧ 2WAY 16AX 250V~ 1M



- SM60PW
- SM60MW
- SM60SB
- SM60AT
- SM60ES
- SM60IW

SWITCH 2WAY 16AX 250V~ 1M

- 16 AX 250 V~, тип SM60
- в съответствие с EN 60669-1
- винтови контакти 1,5 - 2,5 mm²
- сменяем бутон



БУТОН 2WAY 16A 250V~ 1M

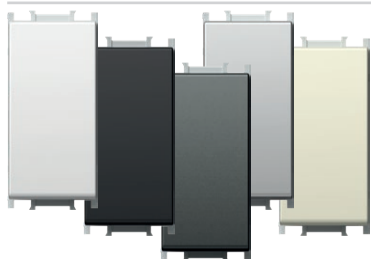

- SM61PW
- SM61MW
- SM61SB
- SM61AT
- SM61ES
- SM61IW

- 16 A 250 V~, тип SM61
 - в съответствие с EN 60669-1
 - винтови контакти 1,5 - 2,5 mm²
 - сменяем бутон

PUSH BUTTON 2WAY 16A 250V~ 1M

- 16A 250V~, type SM61
 - in accordance with EN 60669-1
 - screw contacts 1.5-2.5 mm²
 - replaceable button



БУТОН С ШНУР 2WAY 16A 250V~ 1M



- SM62PWCD
- SM62MWCD
- SM62SBCD
- SM62ATCD
- SM62ESCD
- SM62IWCD

- CD индикатор+шнур
 - дължина на шнура 1.5 m
 - 16 A 250 V~, тип SM62
 - в съответствие с EN 60669-1
 - винтови контакти 1,5 - 2,5 mm²

PUSH BUTTON 2WAY WITH CORD 16A 250V~ 1M __ CD

- CD indicator+cord
 - cord lenght 1.5m
 - 16A 250V~, type SM62
 - in accordance with EN 60669-1
 - screw contacts 1.5-2.5 mm²



КРЪСТАТ КЛЮЧ 16AX 250V~ 1M



- SM70PW
- SM70MW
- SM70SB
- SM70AT
- SM70ES
- SM70IW

- 16 AX 250 V~, тип SM70
 - в съответствие с EN 60669-1
 - винтови контакти 1,5 - 2,5 mm²
 - сменяем бутон

SWITCH INTERMEDIATE 16AX 250V~ 1M

- 16AX 250V~, type SM70
 - in accordance with EN 60669-1
 - screw contacts 1.5-2.5 mm²
 - replaceable button



1M = 22,5 x 45
 2M = 45 x 45

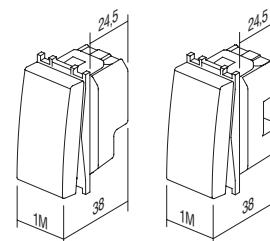

B U T T O N S T M

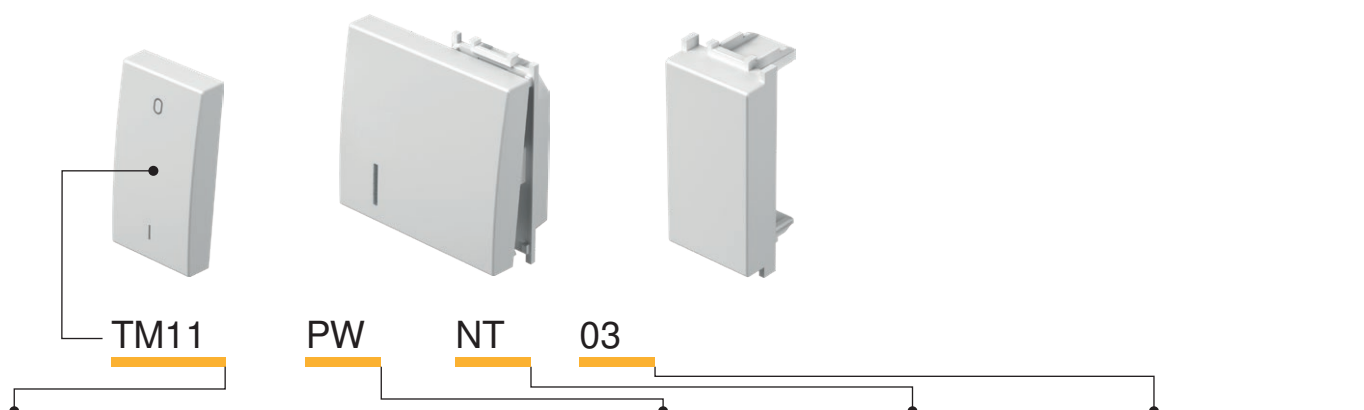

тип type	описание description	размер size	цвет colour	допълнителна информация 1 optional data 1	допълнителна информация 2 optional data 2
TM11	БУТОН BUTTON	1M	<input type="checkbox"/> PW снежнобял цвят polar white	NT неутрален neutral	01
TM12	БУТОН BUTTON	2M	<input type="checkbox"/> MW Бял матов цвят matte white	IN индикатор indicator	02
TM21	КАПАЧЕ BLANK	1M	<input checked="" type="checkbox"/> SB сензорен бутон черен soft touch black		03
:	:	:	<input checked="" type="checkbox"/> AT антрацит anthracite		
:	:	:	<input type="checkbox"/> ES сребрист elox silver		
:	:	:	<input type="checkbox"/> IW слонова кост ivory white		

БУТОН 1M



- TM11PW
- TM11MW
- TM11SB
- TM11AT
- TM11ES
- TM11IW

- сменяем бутон 1M
- в съответствие с EN 60669-1

BUTTON 1M

- replaceable button 1M
- in accordance with EN 60669-1



БУТОН 1M С ИНДИКАТОР



- TM11PWIN
- TM11MWIN
- TM11SBIN
- TM11ATIN
- TM11ESIN
- TM11IWIN

- сменяем бутон 1M
- в съответствие с EN 60669-1

BUTTON 1M INDICATOR

- replaceable button 1M
- in accordance with EN 60669-1



БУТОН 2M

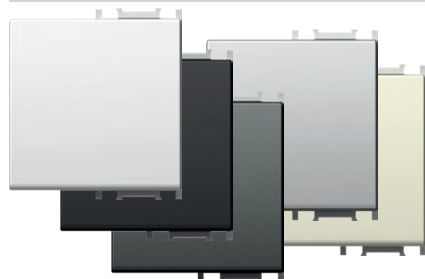

- TM12PW
- TM12MW
- TM12SB
- TM12AT
- TM12ES
- TM12IW

- сменяем бутон 2M с носач за бутон
- за надграждане на ключ или бутон от размер 1M към
размер 2M
- в съответствие с EN 60669-1

BUTTON 2M

- replaceable button 2M with button carrier
- to upgrade switch or push button
from size 1M to size 2M
- in accordance with EN 60669-1



БУТОН 2M С ИНДИКАТОР

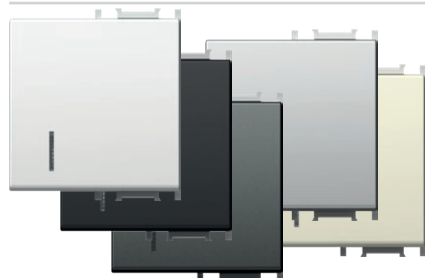

- TM12PWIN
- TM12MWIN
- TM12SBIN
- TM12ATIN
- TM12ESIN
- TM12IWIN

- сменяем бутон 2M с носач за бутон
- за надграждане на ключ или бутон от размер 1M към
размер 2M
- в съответствие с EN 60669-1

BUTTON 2M INDICATOR

- replaceable button 2M with button carrier
- to upgrade switch or push button
from size 1M to size 2M
- in accordance with EN 60669-1



БУТОН 2М С ПАНЕЛ С НАДПИС

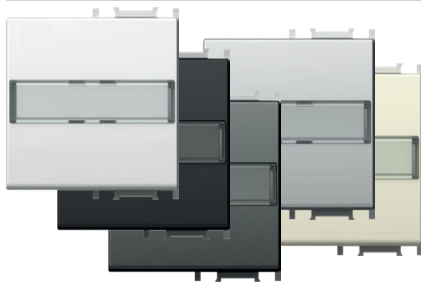

- TM13PWIL
- TM13MWIL
- TM13SBIL
- TM13ATIL
- TM13ESIL
- TM13IWIL

- сменяем бутон 2М с носач за бутон
 - за надграждане на ключ или бутон
 от размер 1М към размер 2М
 - в съответствие с EN 60669-1

BUTTON 2M WITH INSCRIPTION PLATE
 - replaceable button 2M with button carrier
 - to upgrade switch or push button
 from size 1M to size 2M
 - in accordance with EN 60669-1



БУТОН 1М 2ПОЛЕ

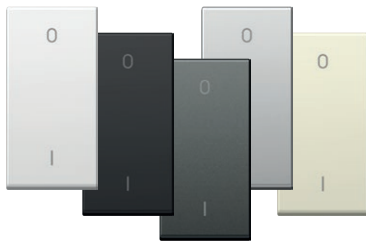

- TM15PW
- TM15MW
- TM15SB
- TM15AT
- TM15ES
- TM15IW

- сменяем бутон 1М
 - само в комбинация с механизъм SM20
 - в съответствие с EN 60669-1

BUTTON 1M 2POLE
 - replaceable button 1M
 - only in combination with mechanism SM20
 - in accordance with EN 60669-1



КАПАЧЕ 1М

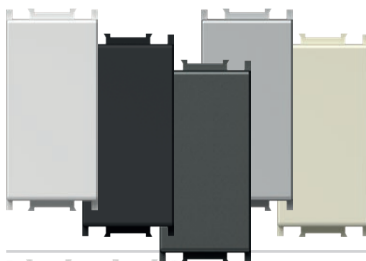

- TM21PW
- TM21MW
- TM21SB
- TM21AT
- TM21ES
- TM21IW

- модулно капаче за покриване на неизползвани позиции
 - в съответствие с EN 60669-1

BLANK 1M
 - blank modul to fill up empty spaces
 - in accordance with EN 60669-1



КАПАЧЕ 2М



- TM22PW
- TM22MW
- TM22SB
- TM22AT
- TM22ES
- TM22IW

- модулно капаче за покриване на неизползвани позиции
 - в съответствие с EN 60669-1

BLANK 2M
 - blank modul to fill up empty spaces
 - in accordance with EN 60669-1



ИЗХОД ЗА КАБЕЛ 1М

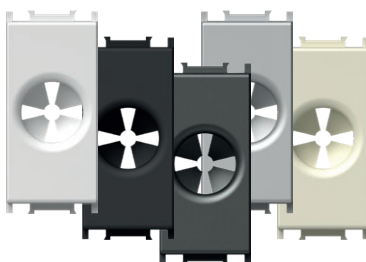

- TM31PW
- TM31MW
- TM31SB
- TM31AT
- TM31ES
- TM31IW

- отвор за изход на кабел
 - в съответствие с EN-60669-1

CABLE OUTLET 1M
 - outlet for cable
 - in accordance with EN-60669-1



1M = 22,5 x 45
 2M = 45 x 45



TM11
 TM15

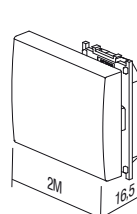

TM12
 TM13

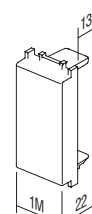

TM21

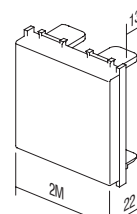

TM22

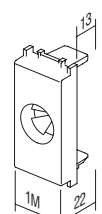

TM31

B U T T O N S T M

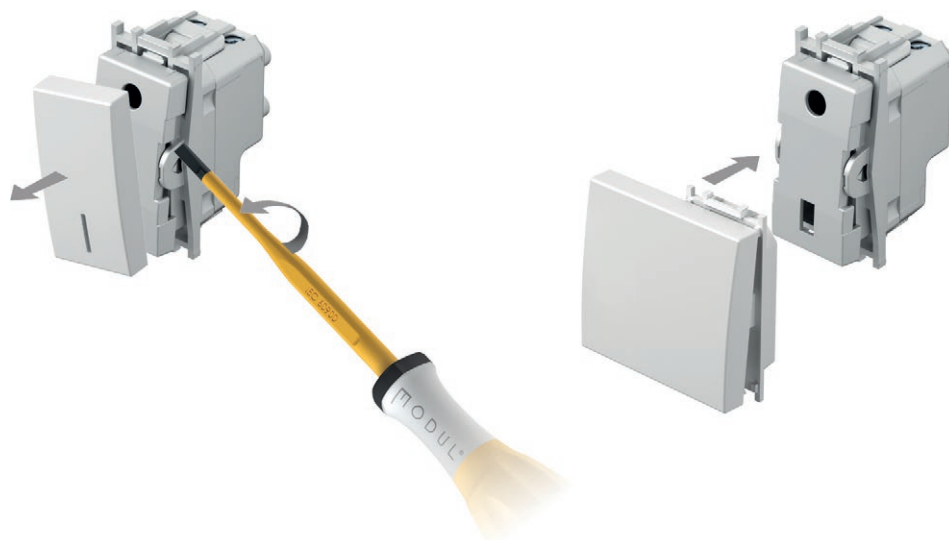

ЛАЗЕРЕН ПЕЧАТ ВЪРХУ БУТОНИ

- лазерно отпечатване на всякакви графични изображения върху маркирани места
 - налични стандартни символи, други – по заявка
- LASER PRINT ON BUTTONS**
- laser print of any graphics on marked locations
 - standard symbols from stock, other on request

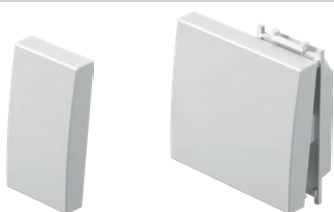

1M

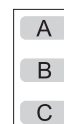

2M

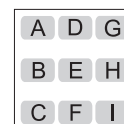

СИМВОЛИ

SYMBOLS

01	02	03	04	05	06	07	08	09	10	11	12	13	14	20	21
													1 0 2	+	-
22	23	24	25	26	27	28	29	30	31	32	33	34	35	36	37
					!	A	OFF	ON	+				AC		
38	39	40	41	42	43	44	45	46	47	48					

СТАНДАРТНИ СИМВОЛИ

STANDARD SYMBOLS

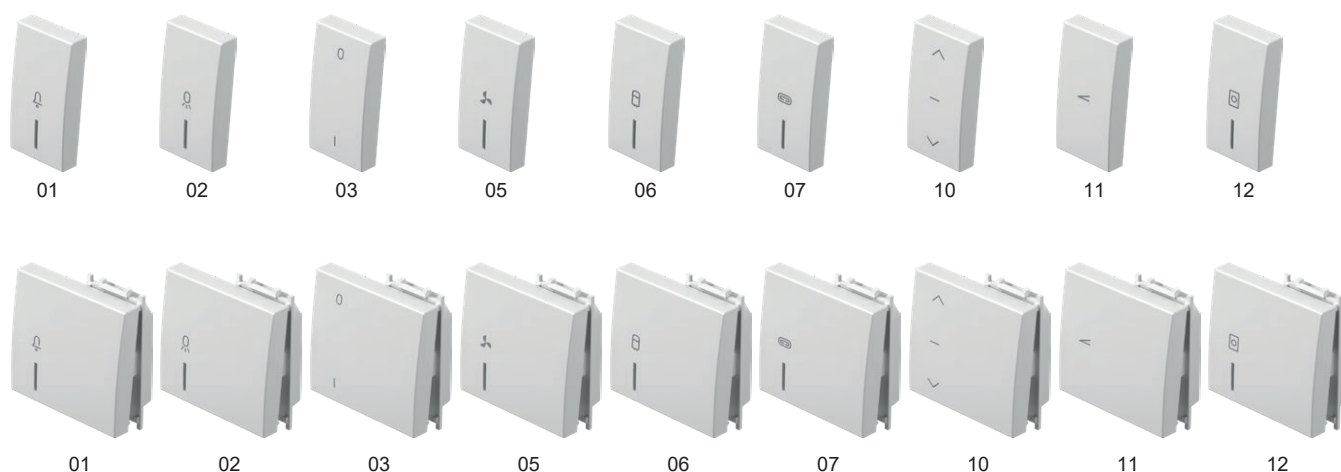

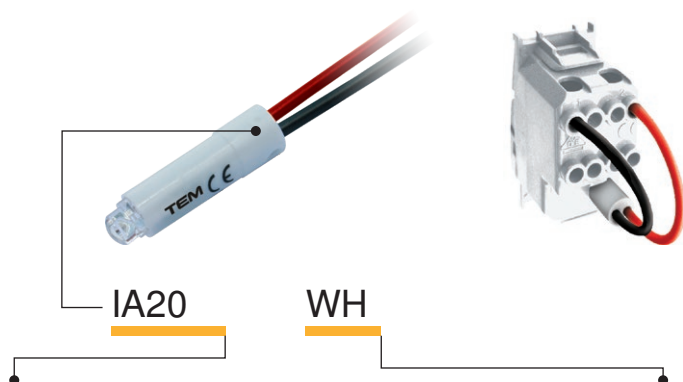

тип type	описание description	технически данни technical data	цвет colour
IA10	НЕОНОВА ЛАМПА NEON LAMP	230V~ 0,34W	<input type="checkbox"/> WH бял цвят white
IA20	СВЕТОДИОДНА СИГНАЛИЗАЦИЯ LED SIGNALLING UNIT	230V~ AC/DC 0,40W	<input checked="" type="checkbox"/> BL син цвят blue
IA21	СВЕТОДИОДНА СИГНАЛИЗАЦИЯ LED SIGNALLING UNIT	24V AC/DC 0,20W	<input checked="" type="checkbox"/> RD червен red
·	·	·	<input checked="" type="checkbox"/> GR зелен green
·	·	·	<input checked="" type="checkbox"/> OR оранжев orange

НЕОНОВА ЛАМПА 230 V~ 0,34 W



IA10OR

- за индикиране, сигнализация или постоянна сигнализация
- в съчетание с бутон с индикатор

NEON LAMP 230V~ 0,34W

- for indication, signalling or permanent signalling
- in combination with a button featuring an indicator

СВЕТОДИОДНА СИГНАЛИЗАЦИЯ 230 V AC/DC 0,40 W



- IA20WH
- IA20GR
- IA20RD
- IA20BL

- за индикиране, сигнализация или постоянна сигнализация
- в съчетание с бутон с индикатор

LED SIGNALLING UNIT 230V AC/DC 0,40W

- for indication, signalling or permanent signalling
- in combination with a button featuring an indicator

СВЕТОДИОДНА СИГНАЛИЗАЦИЯ 24 V AC/DC 0,20 W



- IA21WH
- IA21RD

- за индикиране, сигнализация или постоянна сигнализация
- в съчетание с бутон с индикатор

LED SIGNALLING UNIT LAMP 24V AC/DC 0,20W

- for indication, signalling or permanent signalling
- in combination with a button featuring an indicator

СВЕТОДИОДНА СИГНАЛИЗАЦИЯ 12 V AC/DC 0,10 W



- IA22WH
- IA22RD

- за индикиране, сигнализация или постоянна сигнализация
- в съчетание с бутон с индикатор

LED SIGNALLING UNIT 12V AC/DC 0,10W

- for indication, signalling or permanent signalling
- in combination with a button featuring an indicator

RC ВЕРИГА 250 V~



IA50

- RC верига за отстраняване на смущенията при работата на LED лампи
- възможно е успоредно свързване на няколко RC вериги с лампи
- 0,1 μF, 100 Ω, 250 V~

RC CIRCUIT 250V~

- RC circuit to eliminate disturbances in the operation of LED lamps
- parallel connections of more RC circuits with lamps are possible
- 0,1 μF, 100 Ω, 250V~

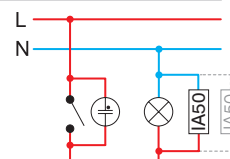

S I G N A L I Z A T I O N I A

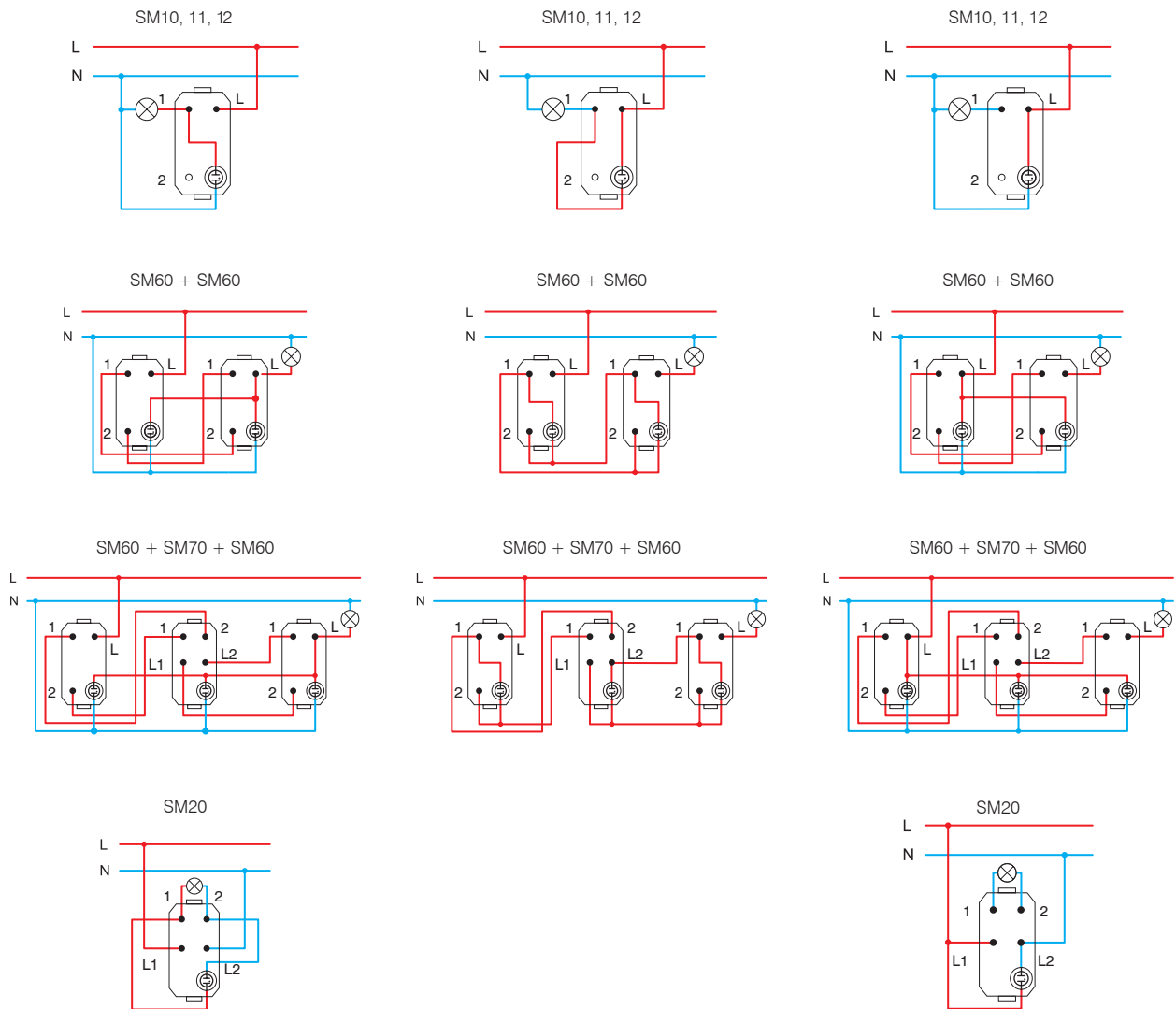
индикация /
Indication* Сигнализация /
SignalizationПостоянна сигнализация /
Permanent signalling

* връзките не са подходящи за енергоспестяващи крушки (CFL, LED) /
the connections are not suitable for energy-saving bulbs (CFL, LED)

1M = 22,5 x 45
2M = 45 x 45

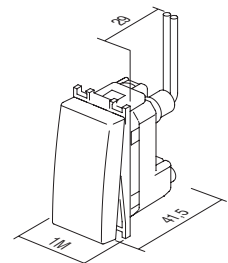

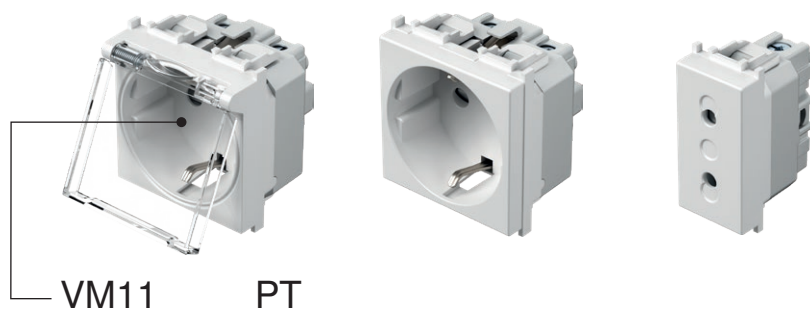

тип type	описание description	технически данни technical data	размер size	цвет colour																																										
VM10	КОНТАКТ ШУКО+KS SOCKET SCHUKO+KS	2P+E 16A 250V~	2M	<table border="0"> <tr> <td><input type="checkbox"/> PW</td> <td>снежнобял polar white</td> <td><input checked="" type="checkbox"/> PT</td> <td>бял + прозрачен white+transparent</td> <td><input type="checkbox"/> PP</td> <td>бял+бял white+white</td> </tr> </table>	<input type="checkbox"/> PW	снежнобял polar white	<input checked="" type="checkbox"/> PT	бял + прозрачен white+transparent	<input type="checkbox"/> PP	бял+бял white+white																																				
<input type="checkbox"/> PW	снежнобял polar white	<input checked="" type="checkbox"/> PT	бял + прозрачен white+transparent	<input type="checkbox"/> PP	бял+бял white+white																																									
VM11	КОНТАКТ ШУКО+KS+КАПАК SOCKET SCHUKO+KS+COVER	2P+E 16A 250V~	2M	<table border="0"> <tr> <td><input type="checkbox"/> MW</td> <td>Бял матов matte white</td> <td><input checked="" type="checkbox"/> MT</td> <td>бял + прозрачен white+transparent</td> <td><input type="checkbox"/> MM</td> <td>бял+бял white+white</td> </tr> </table>	<input type="checkbox"/> MW	Бял матов matte white	<input checked="" type="checkbox"/> MT	бял + прозрачен white+transparent	<input type="checkbox"/> MM	бял+бял white+white																																				
<input type="checkbox"/> MW	Бял матов matte white	<input checked="" type="checkbox"/> MT	бял + прозрачен white+transparent	<input type="checkbox"/> MM	бял+бял white+white																																									
VM20	КОНТАКТ EURO+KS SOCKET EURO+KS	2P 10A 250V~	1M	<table border="0"> <tr> <td><input checked="" type="checkbox"/> SB</td> <td>черен soft touch black</td> <td><input checked="" type="checkbox"/> BT</td> <td>черен + прозрачен soft touch black+transparent</td> <td><input checked="" type="checkbox"/> BB</td> <td>черен+черен soft touch black+black</td> </tr> <tr> <td><input checked="" type="checkbox"/> AT</td> <td>антрацит anthracite</td> <td><input checked="" type="checkbox"/> AT</td> <td>антрацит + прозрачен anthracite+transparent</td> <td><input checked="" type="checkbox"/> AA</td> <td>антрацит+прозрачен anthracite+anthracite</td> </tr> <tr> <td><input checked="" type="checkbox"/> ES</td> <td>сребрист elox silver</td> <td><input checked="" type="checkbox"/> ST</td> <td>сребрист + прозрачен silver+transparent</td> <td><input checked="" type="checkbox"/> SS</td> <td>сребрист+сребрист silver+silver</td> </tr> <tr> <td><input checked="" type="checkbox"/> IW</td> <td>слонова кост ivory white</td> <td><input checked="" type="checkbox"/> IT</td> <td>слонова кост + прозрачен ivory+transparent</td> <td><input checked="" type="checkbox"/> II</td> <td>слонова кост+слонова кост ivory+ivory</td> </tr> <tr> <td><input checked="" type="checkbox"/> RD</td> <td>червен red</td> <td><input checked="" type="checkbox"/> RT</td> <td>червен + прозрачен red+transparent</td> <td><input checked="" type="checkbox"/> RR</td> <td>червен+червен red+red</td> </tr> <tr> <td><input checked="" type="checkbox"/> GR</td> <td>зелен green</td> <td><input checked="" type="checkbox"/> GT</td> <td>зелен + прозрачен green+transparent</td> <td><input checked="" type="checkbox"/> GG</td> <td>зелен+зелен green+green</td> </tr> <tr> <td><input checked="" type="checkbox"/> OR</td> <td>оранжев orange</td> <td><input checked="" type="checkbox"/> OT</td> <td>оранжев + прозрачен orange+transparent</td> <td><input checked="" type="checkbox"/> OO</td> <td>оранжев+оранжев orange+orange</td> </tr> </table>	<input checked="" type="checkbox"/> SB	черен soft touch black	<input checked="" type="checkbox"/> BT	черен + прозрачен soft touch black+transparent	<input checked="" type="checkbox"/> BB	черен+черен soft touch black+black	<input checked="" type="checkbox"/> AT	антрацит anthracite	<input checked="" type="checkbox"/> AT	антрацит + прозрачен anthracite+transparent	<input checked="" type="checkbox"/> AA	антрацит+прозрачен anthracite+anthracite	<input checked="" type="checkbox"/> ES	сребрист elox silver	<input checked="" type="checkbox"/> ST	сребрист + прозрачен silver+transparent	<input checked="" type="checkbox"/> SS	сребрист+сребрист silver+silver	<input checked="" type="checkbox"/> IW	слонова кост ivory white	<input checked="" type="checkbox"/> IT	слонова кост + прозрачен ivory+transparent	<input checked="" type="checkbox"/> II	слонова кост+слонова кост ivory+ivory	<input checked="" type="checkbox"/> RD	червен red	<input checked="" type="checkbox"/> RT	червен + прозрачен red+transparent	<input checked="" type="checkbox"/> RR	червен+червен red+red	<input checked="" type="checkbox"/> GR	зелен green	<input checked="" type="checkbox"/> GT	зелен + прозрачен green+transparent	<input checked="" type="checkbox"/> GG	зелен+зелен green+green	<input checked="" type="checkbox"/> OR	оранжев orange	<input checked="" type="checkbox"/> OT	оранжев + прозрачен orange+transparent	<input checked="" type="checkbox"/> OO	оранжев+оранжев orange+orange
<input checked="" type="checkbox"/> SB	черен soft touch black	<input checked="" type="checkbox"/> BT	черен + прозрачен soft touch black+transparent	<input checked="" type="checkbox"/> BB	черен+черен soft touch black+black																																									
<input checked="" type="checkbox"/> AT	антрацит anthracite	<input checked="" type="checkbox"/> AT	антрацит + прозрачен anthracite+transparent	<input checked="" type="checkbox"/> AA	антрацит+прозрачен anthracite+anthracite																																									
<input checked="" type="checkbox"/> ES	сребрист elox silver	<input checked="" type="checkbox"/> ST	сребрист + прозрачен silver+transparent	<input checked="" type="checkbox"/> SS	сребрист+сребрист silver+silver																																									
<input checked="" type="checkbox"/> IW	слонова кост ivory white	<input checked="" type="checkbox"/> IT	слонова кост + прозрачен ivory+transparent	<input checked="" type="checkbox"/> II	слонова кост+слонова кост ivory+ivory																																									
<input checked="" type="checkbox"/> RD	червен red	<input checked="" type="checkbox"/> RT	червен + прозрачен red+transparent	<input checked="" type="checkbox"/> RR	червен+червен red+red																																									
<input checked="" type="checkbox"/> GR	зелен green	<input checked="" type="checkbox"/> GT	зелен + прозрачен green+transparent	<input checked="" type="checkbox"/> GG	зелен+зелен green+green																																									
<input checked="" type="checkbox"/> OR	оранжев orange	<input checked="" type="checkbox"/> OT	оранжев + прозрачен orange+transparent	<input checked="" type="checkbox"/> OO	оранжев+оранжев orange+orange																																									



КОНТАКТ ШУКО+KS 2P+E 16 A 250 V~ 2M

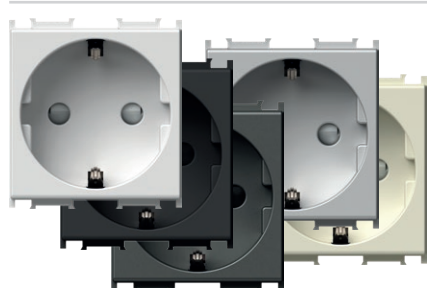

- VM10PW
- VM10MW
- VM10SB
- VM10AT
- VM10ES
- VM10IW

- 2P+E шуко
- 16 A 250 V~, тип VM10
- в съответствие с IEC 60884-1, CEE7
- винтови контакти 1,5 - 2,5 mm²
- Вградена защита от допир на контакти

SOCKET SCHUKO+KS 2P+E 16A 250V~ 2M

- 2P+E schuko
- 16A 250V~, type VM10
- in accordance with IEC 60884-1, CEE7
- screw contacts 1.5-2.5 mm²
- shuttered live contacts



КОНТАКТ ШУКО+KS 2P+E 16 A 250 V~ 2M

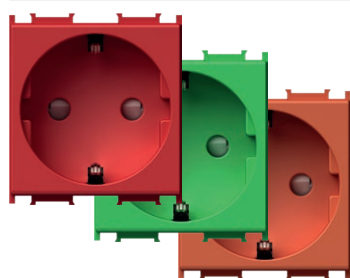

- VM10RD
- VM10GR
- VM10OR

- 2P+E шуко, 16 A 250 V~, тип VM10
- в съответствие с IEC 60884-1, CEE7
- винтови контакти 1,5 - 2,5 mm²
- Вградена защита от допир на контакти

SOCKET SCHUKO+KS 2P+E 16A 250V~ 2M

- 2P+E schuko
- 16A 250V~, type VM10
- in accordance with IEC 60884-1, CEE7
- screw contacts 1.5-2.5 mm²
- shuttered live contacts



КОНТАКТ ШУКО+KS+КАПАК 2P+E 16A 250V~ 2M

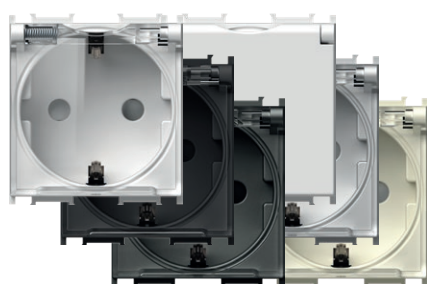

- VM11PT
- VM11MT
- VM11BT
- VM11AT
- VM11ST
- VM11IT
- VM11PP

- 2P+E шуко+капак, 16A 250V~, тип VM11
- в съответствие с IEC 60884-1, CEE7
- винтови контакти 1,5 - 2,5 mm²
- Вградена защита от допир на контакти

SOCKET SCHUKO+KS+COVER

- 2P+E 16A 250V~ 2M
- 2P+E schuko+cover
- 16A 250V~, type VM11
- in accordance with IEC 60884-1, CEE7
- screw contacts 1.5-2.5 mm²
- shuttered live contacts



S O C K E T S V M

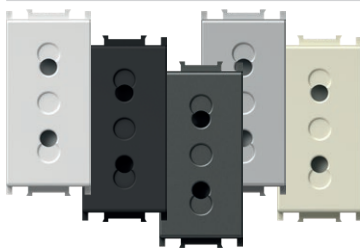

- VM20PW
- VM20MW
- VM20SB
- VM20AT
- VM20ES
- VM20IW

КОТАКТ EURO+KS 2P 10 A 250 V~ 1M

- 2P Euro, 10 A 250 V~, тип VM20
- в съответствие с IEC 60884-1, CEE7
- винтови контакти 1,5 - 2,5 mm²
- Вградена защита от допир на контакти



SOCKET EURO+KS 2P 10A 250V~ 1M

- 2P Euro
- 10A 250V~, type VM20
- in accordance with IEC 60884-1, CEE7
- screw contacts 1.5-2.5 mm²
- shuttered live contacts



- VM40PW
- VM40MW
- VM40SB
- VM40AT
- VM40ES
- VM40IW

ФРЕНСКИ КОНТАКТ +KS 2P+E 16 A 250 V~ 2M



- 2P+E френски контакт, 16 A 250 V~, тип VM40
- в съответствие с IEC 60884-1, NF C 61-314, CEE7
- винтови контакти 1,5 - 2,5 mm²
- Вградена защита от допир на контакти

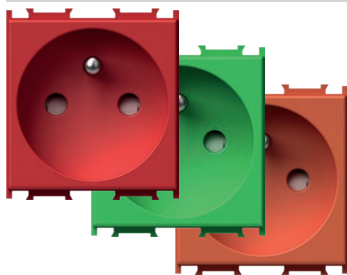

SOCKET FRENCH+KS 2P+E 16A 250V~ 2M

- 2P+E French
- 16A 250V~, type VM40
- in accordance with IEC 60884-1, NF C 61-314, CEE7
- screw contacts 1.5-2.5 mm²
- shuttered live contacts



-  VM40RD
-  VM40GR
-  VM40OR

ФРЕНСКИ КОНТАКТ +KS 2P+E 16 A 250 V~ 2M

- 2P+E френски контакт, 16 A 250 V~, тип VM40
- в съответствие с IEC 60884-1, NF C 61-314, CEE7
- винтови контакти 1,5 - 2,5 mm²
- Вградена защита от допир на контакти



SOCKET FRENCH+KS 2P+E 16A 250V~ 2M

- 2P+E French
- 16A 250V~, type VM40
- in accordance with IEC 60884-1, NF C 61-314, CEE7
- screw contacts 1.5-2.5 mm²
- shuttered live contacts



- VM41PT
- VM41MT
- VM41BT
- VM41AT
- VM41PP
- VM41ST
- VM41IT

ФРЕНСКИ КОНТАКТ+KS+КАПАК 2P+E 16A 250V~ 2M

- 2P+E френски контакт+капак, 16A 250V~, тип VM41
- в съответствие с IEC 60884-1, NF C 61-314, CEE7
- винтови контакти 1,5 - 2,5 mm²
- Вградена защита от допир на контакти

SOCKET FRENCH+KS+COVER
2P+E 16A 250V~ 2M

- 2P+E French+cover
- 16A 250V~, type VM41
- in accordance with IEC 60884-1, NF C 61-314, CEE7
- screw contacts 1.5-2.5 mm²
- shuttered live contacts

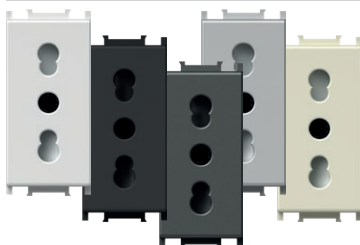

- VM30PW
- VM30MW
- VM30SB
- VM30AT
- VM30ES
- VM30IW

ИТАЛИАНСКИ КОНТАКТ P17/11+KS 2P+E 16 A 250 V~ 1M

- 2P+E Италиански контакт P17/11, 16 A 250 V~, тип VM30
- в съответствие с IEC 60884-1, CEI 23-50
- винтови контакти 1,5 - 2,5 mm²
- Вградена защита от допир на контакти



SOCKET ITALIAN P17/11+KS 2P+E 16A 250V~ 1M

- 2P+E Italian P17/11
- 16A 250V~, type VM30
- in accordance with IEC 60884-1, CEI 23-50
- screw contacts 1.5-2.5 mm²
- shuttered live contacts

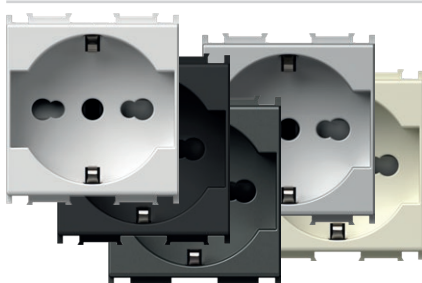

- VM31PW
- VM31MW
- VM31SB
- VM31AT
- VM31ES
- VM31IW

КОНТАКТ SCHUKO/ITA P17/11+KS 2P+E 16A 250V~ 2M

- 2P+E/контакт шuko/италиански P17/11, 16A 250V~, тип VM31
- в съответствие с IEC 60884-1, CEI 23-50
- винтови контакти 1,5 - 2,5 mm²
- Вградена защита от допир на контакти

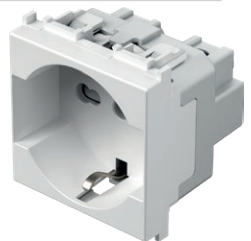
SOCKET SCHUKO/ITA P17/11+KS
2P+E 16A 250V~ 2M

- 2P+E schuko/Italian P17/11
- 16A 250V~, type VM31
- in accordance with IEC 60884-1, CEI 23-50
- screw contacts 1.5-2.5 mm²
- shuttered live contacts

КОНТАКТ ШУКО/ИТА P30+KS 2P+E 16A 250V~ 2M

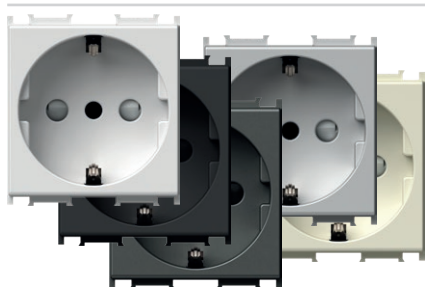

- VM32PW
- VM32MW
- VM32SB
- VM32AT
- VM32ES
- VM32IW

- 2P+E/контакт шуко/италиански P30, 16A 250V~, тип VM32
- в съответствие с IEC 60884-1, CEI 23-50
- винтови контакти 1,5 - 2,5 mm²
- Вградена защита от допир на контакти



SOCKET SCHUKO/ITA P30+KS 2P+E 16A 250V~ 2M

- 2P+E schuko/Italian P30
- 16A 250V~, type VM32
- in accordance with IEC 60884-1, CEI 23-50
- screw contacts 1.5-2.5 mm²
- shuttered live contacts

ИТАЛИАНСКИ КОНТАКТ P11+KS 2P+E 10 A 250 V~ 1M

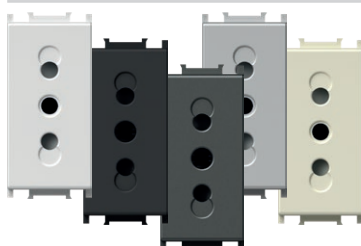

- VM33PW
- VM33MW
- VM33SB
- VM33AT
- VM33ES
- VM33IW

- 2P+E Италиански контакт P11, 10 A 250 V~, тип VM33
- в съответствие с IEC 60884-1, CEI 23-50
- винтови контакти 1,5 - 2,5 mm²
- Вградена защита от допир на контакти



SOCKET ITALIAN P11+KS 2P+E 10A 250V~ 1M

- 2P+E Italian P11
- 10A 250V~, type VM33
- in accordance with IEC 60884-1, CEI 23-50
- screw contacts 1.5-2.5 mm²
- shuttered live contacts

КОНТАКТ EURO/АМЕРИКАНСКИ+KS 2P 16 A 250 V~ 1M

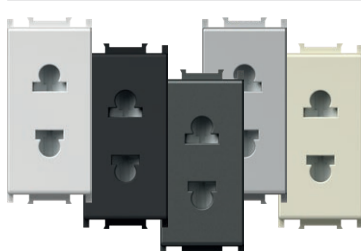

- VM21PW
- VM21MW
- VM21SB
- VM21AT
- VM21ES
- VM21IW

- 2P Euro/американски, 16 A 250 V~, тип VM21
- винтови контакти 1,5 - 2,5 mm²
- Вградена защита от допир на контакти
- само за страни, които не са членки в ЕС



SOCKET EURO/AMERICAN+KS 2P 16A 250V~ 1M

- 2P Euro/American
- 16A 250V~, type VM21
- screw contacts 1.5-2.5 mm²
- shuttered live contacts
- only for countries not members of EU

БРИТАНСКИ КОНТАКТ BS 1363-2+KS 2P+E 13 A 250 V~ 2M

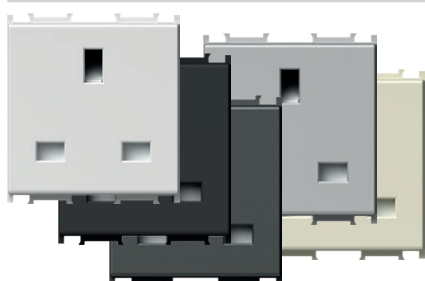

- VM52PW
- VM52MW
- VM52SB
- VM52AT
- VM52ES
- VM52IW

- 2P+E британски контакт BS 1363-2, 13 A 250 V~, тип VM52
- в съответствие с BS 1363-2
- винтови контакти 1,5 - 4 mm²
- Вградена защита от допир на контакти



SOCKET BRITISH BS 1363-2+KS 2P+E 13A 250V~ 2M

- 2P+E British BS 1363-2
- 13A 250V~, type VM52
- in accordance with BS 1363-2
- screw contacts 1.5-4 mm²
- shuttered live contacts

КОНТАКТ МУЛТИСТАНДАРТНИЯТ+KS 2P+E 13A 250V~ 2M

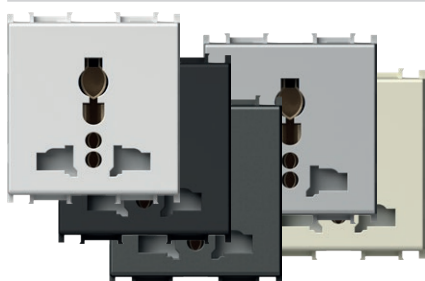

- VM55PW
- VM55MW
- VM55SB
- VM55AT
- VM55ES
- VM55IW

- контакти чрез вкарване 1,5 - 2,5 mm²
- Вградена защита от допир на контакти

SOCKET MULTI-STANDARD+KS 2P+E 13A 250V~ 2M

- plug-in contacts 1.5-2.5 mm²
- shuttered live contacts



УСТРОЙСТВО ЗА ЗАЩИТА СРЕЩУ ОТСКОЦИ НА НАПРЕЖЕНИЕТО MPE MINI 275 V/50 Hz



VM80

- успоредно свързване с първия контакт в реда
- клас на защита III
- U_c=275Vac, U_{oc}/I_{sc}=6kV/3kA, U_p<800V
- в съответствие с IEC 61643-1
- проводници 1,5 mm², IP20
- звук сигнал при прекъсване





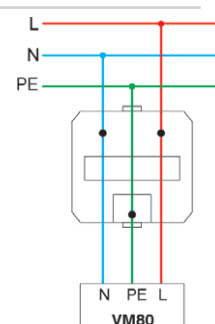





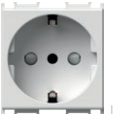

SURGE PROTECTOR MPE MINI 275V/50Hz

- parallel connection with the first socket in the row
- protection class III
- U_c=275Vac, U_{oc}/I_{sc}=6kV/3kA, U_p<800V
- in accordance with IEC 61643-1
- wires 1.5mm², IP20
- sound signal at breakdown







S O C K E T S V M

СЪОТВЕТВИЕ НА КОНТАКТИ И ЩЕПСЕЛИ
SOCKETS AND PLUGS MATCHING

КОНТАКТ / SOCKET									
ТИП НА ЩЕПСЕЛА / PLUG STYLE	VM10 VM11	VM20	VM30	VM33	VM31	VM32	VM40 VM41	VM21	VM55
Немски / German 	•				•	•			•
Френски / French 	•				•	•	•		•
Италиански / Italian S11 			•	•	•	•			•
Италиански / Italian S17 			•		•				•
euro 	•	•	•		•	•	•	•	•

СЪОТВЕТВИЕ НА КОНТАКТИ И ЩЕПСЕЛИ
SOCKETS AND PLUGS MATCHING

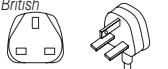
КОНТАКТ / SOCKET			
ТИП НА ЩЕПСЕЛА / PLUG STYLE	VM21	VM52	VM55
Американски / American 	•		•
Британски / British BS 1363-2 		•	•

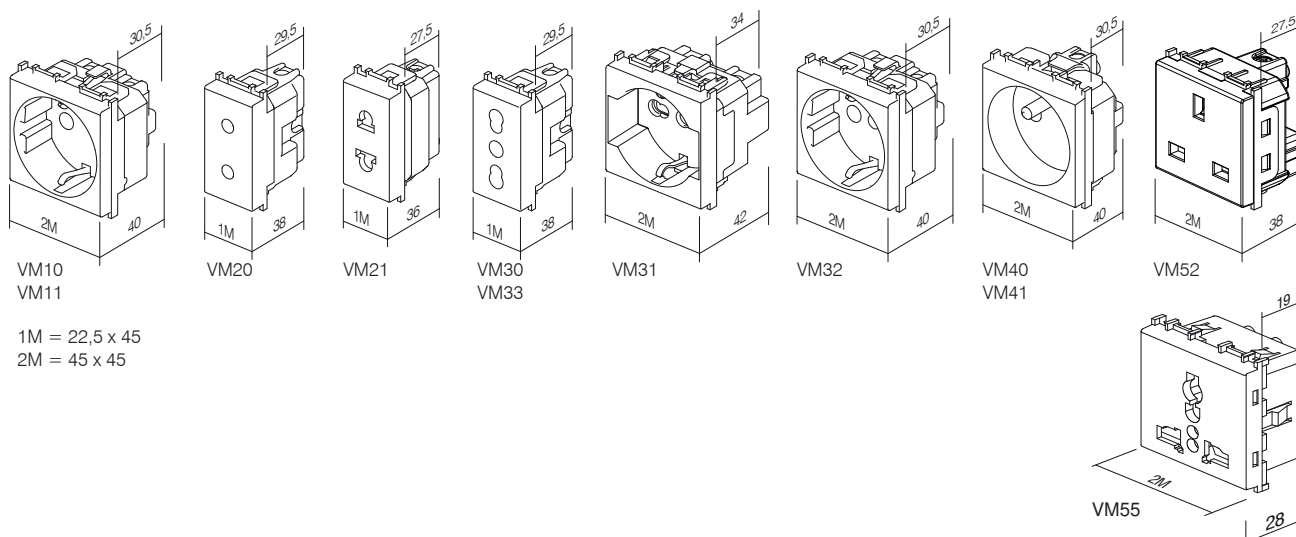



тип type	описание description	технически данни technical data	размер size	цвет colour
KM10	КОНЕКТОР ЗА ТВ ОСНОВЕН SOCKET TV BASIC	0dB	1M	<input type="checkbox"/> PW снежнобял цвят polar white
KM11	КОНЕКТОР ЗА ТВ КРАЕН SOCKET TV END-LINE	1dB	1M	<input type="checkbox"/> MW Бял матов цвят matte white
KM12	КОНЕКТОР ЗА ТВ ПРЕХОДЕН SOCKET TV TROUGHPASS	10dB	1M	<input checked="" type="checkbox"/> SB сензорен бутон черен soft touch black
:	:	:	:	<input checked="" type="checkbox"/> AT антрацит anthracite
:	:	:	:	<input type="checkbox"/> ES сребрист elox silver
:	:	:	:	<input type="checkbox"/> IW слонова кост ivory white

КОНЕКТОР ЗА ТВ ОСНОВЕН 0 dB 1M



- KM10PW
- KM10MW
- KM10SB
- KM10AT
- KM10ES
- KM10IW

- контакт за ТВ базов
- затихване 0 dB
- заден конектор – стандарт F
SOCKET TV BASIC 0dB 1M
- TV basic
- reduction 0dB
- back connector – F standard



КОНЕКТОР ЗА ТВ ОСНОВЕН 0 dB 2M

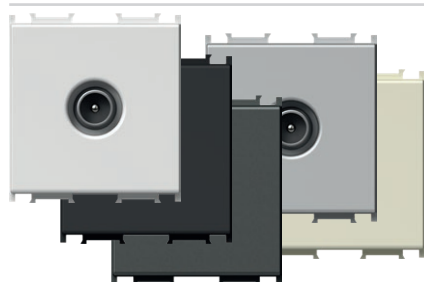

- KM20PW
- KM20MW
- KM20SB
- KM20AT
- KM20ES
- KM20IW

- контакт за ТВ базов
- затихване 0 dB
- заден конектор – стандарт F
SOCKET TV BASIC 0dB 2M
- TV basic
- reduction 0dB
- back connector – F standard



КОНЕКТОР ЗА ТВ КРАЕН 1 dB 1M



- KM11PW
- KM11MW
- KM11SB
- KM11AT
- KM11ES
- KM11IW

- контакт за ТВ краен
- честотен обхват 5÷2400 MHz
- затихване < 1 dB
- в съответствие с EN 50083-1
- винтови контакти
SOCKET TV END-LINE 1dB 1M
- TV end-line
- frequency range 5÷2400 MHz
- reduction < 1 dB
- in accordance with EN 50083-1
- screw contacts

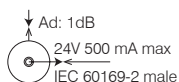

КОНЕКТОР ЗА ТВ ПРЕХОДЕН 10 dB 1M



- KM12PW
- KM12MW
- KM12SB
- KM12AT
- KM12ES
- KM12IW

- преходник за ТВ сигнал
- честотен обхват 5÷2400 MHz
- затихване < 10 dB
- в съответствие с EN 50083-1
- винтови контакти
SOCKET TV TROUGHPASS 10dB 1M
- TV troughpass
- frequency range 5÷2400 MHz
- reduction < 10 dB
- in accordance with EN 50083-1
- screw contacts

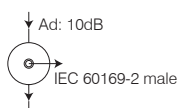

КОНЕКТОР ЗА САТЕЛИТНА ТВ БАЗОВ 0 dB 1M



- KM15PW
- KM15MW
- KM15SB
- KM15AT
- KM15ES
- KM15IW

- контакт за сателитна ТВ базов
 - затихване 0 dB
 - заден конектор – стандарт F
SOCKET SAT BASIC 0dB 1M
 - SAT basic
 - reduction 0dB
 - back connector – F standard



КОНЕКТОР ЗА САТЕЛИТНА ТВ БАЗОВ 0 dB 2M

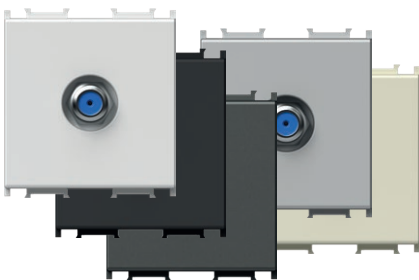

- KM24PW
- KM24MW
- KM24SB
- KM24AT
- KM24ES
- KM24IW

- контакт за сателитна ТВ базов
 - затихване 0 dB
 - заден конектор – стандарт F
SOCKET SAT BASIC 0dB 2M
 - SAT basic
 - reduction 0dB
 - back connector – F standard



КОНЕКТОР ЗА САТЕЛИТНА ТВ КРАЕН 1 dB 1M



- KM16PW
- KM16MW
- KM16SB
- KM16AT
- KM16ES
- KM16IW

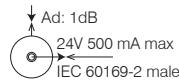

- конектор за сателитна ТВ краен
 - честотен обхват 5÷2400 MHz
 - затихване 1 dB
 - в съответствие с EN 50083-1
 - винтови контакти
SOCKET SAT END-LINE 1dB 1M
 - SAT end-line
 - frequency range 5÷2400 MHz
 - reduction < 1dB
 - in accordance with EN 50083-1
 - screw contacts



КОНЕКТОР ЗА РАДИО ОСНОВЕН 0 dB 1M



- KM19PW
- KM19MW
- KM19SB
- KM19AT
- KM19ES
- KM19IW

- контакт за радио базов
 - затихване 0 dB
 - заден конектор – стандарт F
SOCKET R BASIC 0dB 1M
 - R basic
 - reduction 0dB
 - back connector – F standard



КОНЕКТОР ЗА РАДИО ОСНОВЕН 0 dB 2M

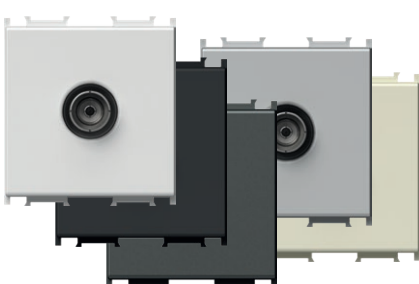

- KM29PW
- KM29MW
- KM29SB
- KM29AT
- KM29ES
- KM29IW

- контакт за радио базов
 - затихване 0 dB
 - заден конектор – стандарт F
SOCKET R BASIC 0dB 2M
 - R basic
 - reduction 0dB
 - back connector – F standard



КОНЕКТОР ЗА САТЕЛИТНА ТВ КРАЕН 1 dB 2M

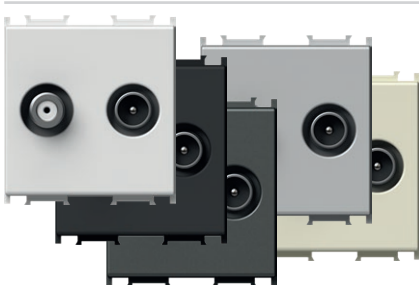

- KM25PW
- KM25MW
- KM25SB
- KM25AT
- KM25ES
- KM25IW

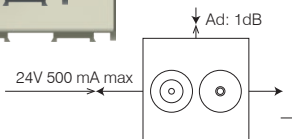

- контакт за сателитна ТВ краен
 - честотен обхват 5÷2400 MHz
 - затихване 1 dB
 - в съответствие с EN 50083-1
 - винтови контакти
SOCKET SAT-TV END-LINE 1dB 2M
 - SAT-TV end-line
 - frequency range 5÷2400 MHz
 - reduction < 1dB
 - in accordance with EN 50083-1
 - screw contacts



ПРИМЕРИ ЗА ОСНОВНО СВЪРЗВАНЕ

BASIC CONNECTION SAMPLES

индивидуално свързване
stand alone connection

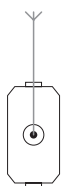

KM10
KM20
KM11
KM15
KM24
KM16
KM19
KM29
KM25

свързване тип звезда
star connection

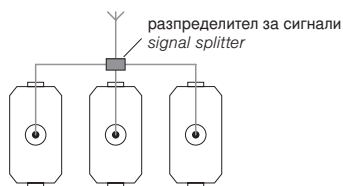

KM10
KM20
KM11
KM15
KM24
KM16
KM19
KM29
KM25

преходно свързване
throughpass connection

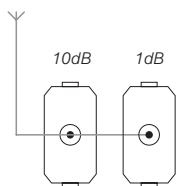

KM12 KM11



- KM22PW
- KM22MW
- KM22SB
- KM22AT
- KM22ES
- KM22IW

КОНТАКТ ЗА АУДИОСИГНАЛИ 2xRCA 1M

- за аудиосигнали, с конектори 2x RCA
- свързване на кабела от задната страна чрез запояване

SOCKET AUDIO 2xRCA 1M

- audio 2x RCA
- soldering connection of cable at the back side



- KM23PW
- KM23MW
- KM23SB
- KM23AT
- KM23ES
- KM23IW

КОНЕКТОР ЗА ВИСОКОГОВОРТЕЛИ 1M

- за аудиосигнали, 2x Ø4 mm
- за проводник за високоговорители, с щепсел тип банан Ø4 mm или плоски конектори
- свързване на кабела от задната страна чрез запояване

SOCKET AUDIO LOUDSPEAKERS 1M

- audio 2x Ø4mm
- to accommodate speaker wire, banana plug Ø4mm or spades
- soldering connection of cable at the back side



- KM26PW
- KM26MW
- KM26SB
- KM26AT
- KM26ES
- KM26IW

КОНЕКТОР ЗА ВИСОКОГОВОРТЕЛИ 2M

- за аудиосигнали, 2x Ø4 mm
- за проводник за високоговорители, с щепсел тип банан Ø4 mm или плоски конектори
- свързване на кабела от задната страна чрез запояване

SOCKET AUDIO LOUDSPEAKERS 2M

- audio 2x Ø4mm
- to accommodate speaker wire, banana plug Ø4mm or spades
- soldering connection of cable at the back side



1M = 22,5 x 45
2M = 45 x 45

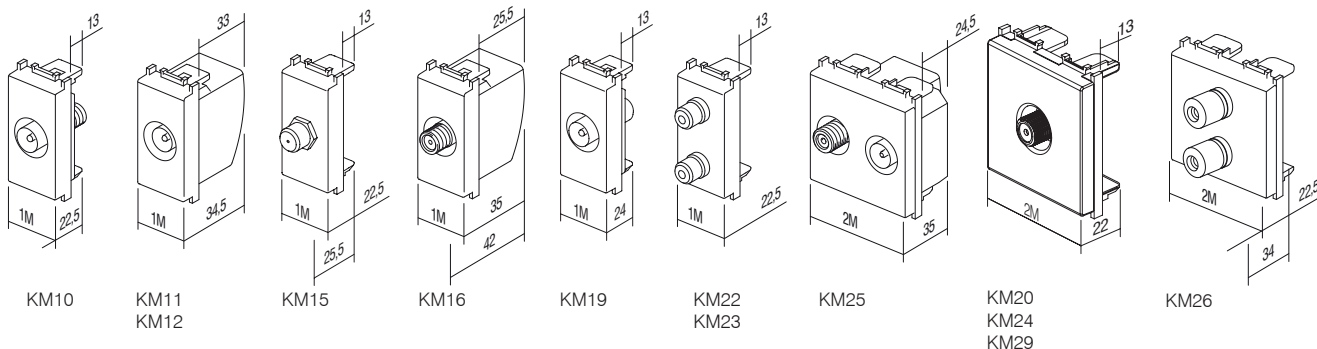

КОНЕКТОР ЗА ТЕЛЕФОН LT RJ11 6/4 1M



- KM30PW
- KM30MW
- KM30SB
- KM30AT
- KM30ES
- KM30IW

- телефонен LT винтов
- RJ11 6/4
- в съответствие с IEC 60603-7
- винтови контакти

SOCKET TEL LT RJ11 6/4 1M

- TEL LT screw
- RJ11 6/4
- in accordance with IEC 60603-7
- screw contacts



КОНЕКТОР TEL BT SEC 6/6 1M

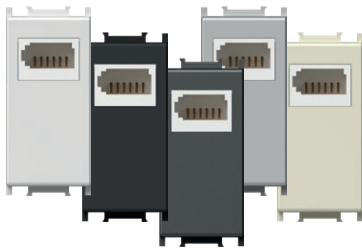

- KM31PW
- KM31MW
- KM31SB
- KM31AT
- KM31ES
- KM31IW

- ТЕЛЕФОНЕН BT британски стандарт
- SEC вторичен 6/6
- в съответствие с BS 6312
- винтови контакти

SOCKET TEL BT SEC 6/6 1M

- TEL BT British standard
- SEC secondary 6/6
- in accordance with BS 6312
- screw contacts



КОНЕКТОР ЗА ТЕЛЕФОН KS RJ11 6/4 1M

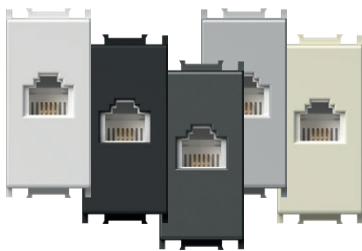

- KM36PW
- KM36MW
- KM36SB
- KM36AT
- KM36ES
- KM36IW

- KS модулнен стандарт за закрепване
- RJ11 6/4
- в съответствие с IEC 60603-7

SOCKET TEL KS RJ11 6/4 1M

- KS keystone fixing standard
- RJ11 6/4
- in accordance with IEC 60603-7

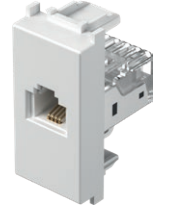

КОНЕКТОР CAT5e KS RJ45 8/8 1M

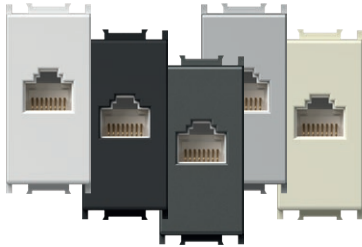

- KM37PW
- KM37MW
- KM37SB
- KM37AT
- KM37ES
- KM37IW

- KS модулнен стандарт за закрепване
- CAT5e, RJ45 8/8
- в съответствие с IEC 60603-7

SOCKET CAT5e KS RJ45 8/8 1M

- KS keystone fixing standard
- CAT5e, RJ45 8/8
- in accordance with IEC 60603-7

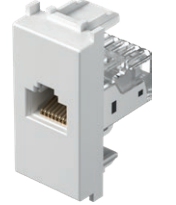

АДАПТЕР KS 1M

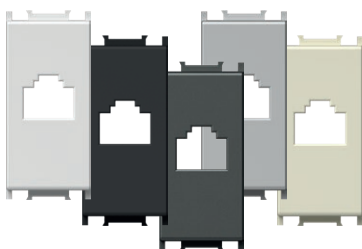

- KM35PW
- KM35MW
- KM35SB
- KM35AT
- KM35ES
- KM35IW

- KS модулнен стандарт за закрепване
- AMP, Avaya, Brandrex, FMT, Mfico, Tyco, ...
- комуникационният модул не е включен в доставката

ADAPTER KS 1M

- KS keystone fixing standard
- AMP, Avaya, Brandrex, FMT, Mfico, Tyco, ...
- communication module not included

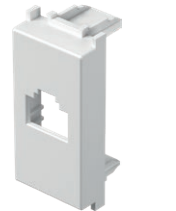

АДАПТЕР СЪС ЗАЩИТА ПРОТИВ ПРАХ 1M



- KM38PW
- KM38MW
- KM38SB
- KM38AT
- KM38ES
- KM38IW

- KS модулнен стандарт за закрепване със защита против прах
- AMP, Avaya, Brandrex, FMT, Mfico, Tyco, ...
- комуникационният модул не е включен в доставката

ADAPTER KS WITH DUST PROTECTION 1M

- KS keystone fixing standard with dust protection
- AMP, Avaya, Brandrex, FMT, Mfico, Tyco, ...
- communication module not included



КОНЕКТОР CAT6 SCH KS RJ45 8/8 1M

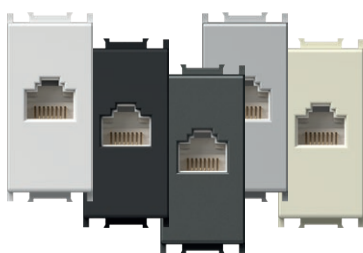

- KM39PW
- KM39MW
- KM39SB
- KM39AT
- KM39ES
- KM39IW

- KS модулен стандарт за закрепване
- CAT6 UTP без нужда от инструменти, RJ45 8/8
- в съответствие с ISO/IEC 11801

SOCKET CAT6 SCH KS RJ45 8/8 1M

- KS keystone fixing standard
- CAT6 UTP toolless, RJ45 8/8
- in accordance with ISO/IEC 11801



УНИВЕРСАЛЕН АДАПТЕР KS 1M

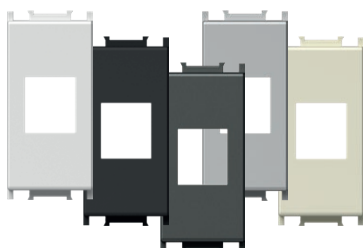

- KM50PW
- KM50MW
- KM50SB
- KM50AT
- KM50ES
- KM50IW

- KS модулен стандарт за закрепване
- подходящ за HDMI, USB
- комуникационният модул не е включен в доставката

ADAPTER KS UNIVERSAL 1M

- KS keystone fixing standard
- suitable for HDMI, USB
- communication module not included



АДАПТЕР PD 1M

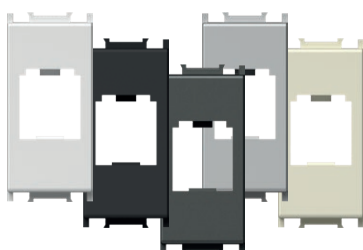

- KM40PW
- KM40MW
- KM40SB
- KM40AT
- KM40ES
- KM40IW

- стандарт за закрепване PD Panduit Mini-COM
- комуникационният модул не е включен в доставката

ADAPTER PD 1M

- PD Panduit Mini-COM fixing standard
- communication module not included



АДАПТЕР PD СЪС ЗАЩИТА ПРОТИВ ПРАХ 1M



- KM43PW
- KM43MW
- KM43SB
- KM43AT
- KM43ES
- KM43IW

- стандарт за закрепване PD Panduit Mini-COM със защита против прах
- комуникационният модул не е включен в доставката

ADAPTER PD WITH DUST PROTECTION 1M

- PD Panduit Mini-COM fixing standard with dust protection
- communication module not included



АДАПТЕР R&M 1M

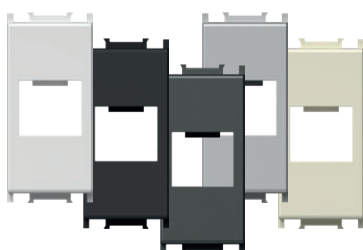

- KM46PW
- KM46MW
- KM46SB
- KM46AT
- KM46ES
- KM46IW

- стандарт за закрепване R&M
- комуникационният модул не е включен в доставката

ADAPTER R&M 1M

- R&M fixing standard
- communication module not included



АДАПТЕР R&M CAT6A 1M

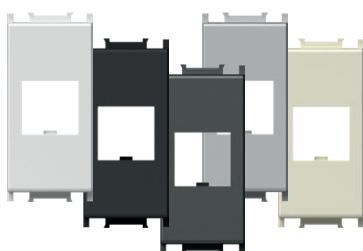

- KM52PW
- KM52MW
- KM52SB
- KM52AT
- KM52ES
- KM52IW

- закрепване R&M за CAT6A
- комуникационният модул не е включен в доставката

ADAPTER R&M CAT6A 1M

- R&M fixing for CAT6A
- communication module not included





- KM47PW
- KM47MW
- KM47SB
- KM47AT
- KM47ES
- KM47IW

АДАПТЕР R&M СЪС ЗАЩИТА ПРОТИВ ПРАХ 1M

- стандарт за закрепване R&M със защита против прах
- комуникационният модул не е включен в доставката

ADAPTER R&M WITH DUST PROTECTION 1M

- R&M fixing standard with dust protection
- communication module not included



- KM53PW
- KM53MW
- KM53SB
- KM53AT
- KM53ES
- KM53IW

АДАПТЕР R&M CAT6A СЪС ЗАЩИТА ПРОТИВ ПРАХ 1M

- закрепване R&M за CAT6A със защита против прах
- комуникационният модул не е включен в доставката

ADAPTER R&M CAT6A WITH DUST PROTECTION 1M

- R&M fixing for CAT6A with dust protection
- communication module not included



АДАПТЕР LK 1M

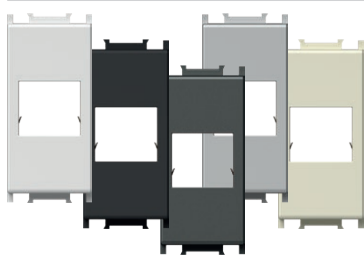

- KM45PW
- KM45MW
- KM45SB
- KM45AT
- KM45ES
- KM45IW

- стандарт за закрепване LK LeoniKerpen eLine/BKS NewLine
- комуникационният модул не е включен в доставката

ADAPTER LK 1M

- LK LeoniKerpen eLine / BKS NewLine fixing standard
- communication module not included



АДАПТЕР NEXANS/SCHRACK 2M

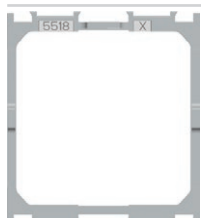

KA26

- адаптер за закрепване за Nexans LANmark и LANmark за Schrack размер 45x45 mm
- модул Schrack 45x45 mm
- подходящ за Schrack тип HSEMD02W2F
- комуникационният модул не е включен в доставката

ADAPTER NEXANS/SCHRACK 2M

- fixing adapter for Nexans LANmark and Schrack module 45x45mm
- suitable for Nexans type N423.540N
- suitable for Schrack type HSEMD02W2F
- communication module not included

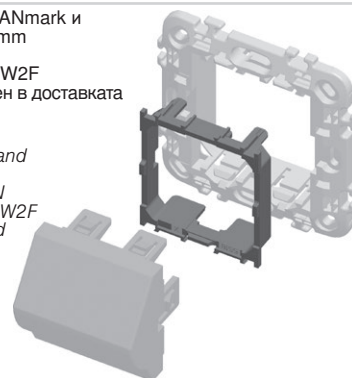

АДАПТЕР AT&T SYSTIMAX СЪС ЗАЩИТА ПРОТИВ ПРАХ 1M

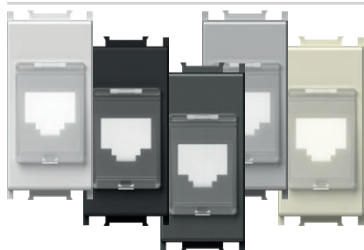

- KM48PW
- KM48MW
- KM48SB
- KM48AT
- KM48ES
- KM48IW

- стандарт за закрепване AT&T Systimax със защита против прах
- комуникационният модул не е включен в доставката

ADAPTER AT&T SYSTIMAX WITH DUST PROTECTION 1M

- AT&T Systimax fixing standard with dust protection
- communication module not included



КОНЕКТОР USB ТИП А 1M



- KM51PW
- KM51MW
- KM51SB
- KM51AT
- KM51ES
- KM51IW

- конектор тип А за USB 2.0
- винтови контакти, стъпка 5 mm, 1,5 mm², 1x2P + 1x3P
- свързване:
 Щифт 1 – VCC (+5V, червен проводник)
 Щифт 2 – Данни – (бял проводник)
 Щифт 3 – Данни + (зелен проводник)
 Щифт 4 – МАСА - (черен проводник)
 S – екранировка
- в съответствие с Директива 2011/95/EC (RoHS2)

SOCKET USB TYPE A 1M

- USB 2.0 socket type A
- screw contacts, raster 5 mm, 1,5 mm², 1x2P + 1x3P
- wiring:
 PIN 1 – VCC (+5V, red wire)
 PIN 2 – Data - (white wire)
 PIN 3 – Data + (green wire)
 PIN 4 – GND - ground (black wire)
 S – shield
- in accordance with directive 2011/95/EU (RoHS2)



1M = 22,5 x 45
2M = 45 x 45

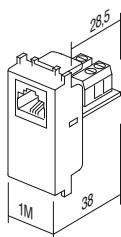

KM30

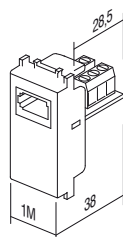

KM31

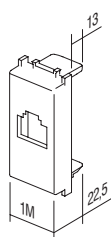

KM35
KM38
KM48

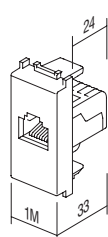

KM36
KM37
KM39

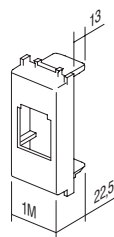

KM40
KM43

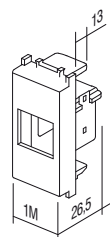

KM45

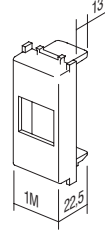

KM46
KM47
KM50
KM52
KM53

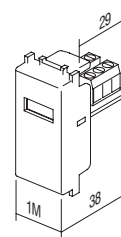

KM51



KA10

тип <i>type</i>	описание <i>description</i>	технически данни <i>technical data</i>
KA10	КОНЕКТОР KS CAT3 <i>CONNECTOR KS CAT3</i>	RJ11 6/4
KA11	КОНЕКТОР KS CAT5e <i>CONNECTOR KS CAT5e</i>	RJ45 8/8
KA12	КОНЕКТОР KS CAT5eS <i>CONNECTOR KS CAT5eS</i>	RJ45 8/8
⋮	⋮	⋮



KA10	<p>КОНЕКТОР KS CAT3 RJ11 6/4</p> <ul style="list-style-type: none"> - KS модулен стандарт за закрепване - CAT3, RJ11 6/4 - в съответствие с IEC 60603-7 <p><i>CONNECTOR KS CAT3 RJ11 6/4</i></p> <ul style="list-style-type: none"> - KS keystone fixing standard - CAT3, RJ11 6/4 - in accordance with IEC 60603-7
------	---



KA11	<p>КОНЕКТОР KS CAT5e RJ45 8/8</p> <ul style="list-style-type: none"> - KS модулен стандарт за закрепване - CAT5e, RJ45 8/8 - в съответствие с IEC 60603-7 <p><i>CONNECTOR KS CAT5e RJ45 8/8</i></p> <ul style="list-style-type: none"> - KS keystone fixing standard - CAT5e, RJ45 8/8 - in accordance with IEC 60603-7
------	---



KA12	<p>КОНЕКТОР KS CAT5eS RJ45 8/8</p> <ul style="list-style-type: none"> - KS модулен стандарт за закрепване - CAT5eS, RJ45 8/8 - в съответствие с IEC 60603-7 <p><i>CONNECTOR KS CAT5eS RJ45 8/8</i></p> <ul style="list-style-type: none"> - KS keystone fixing standard - CAT5eS, RJ45 8/8 - in accordance with IEC 60603-7
------	---



KA15	<p>КОНЕКТОР KS CAT6 SCH RJ45 8/8</p> <ul style="list-style-type: none"> - KS модулен стандарт за закрепване - CAT6 UTP без нужда от инструменти, RJ45 8/8 - в съответствие с ISO/IEC 11801 <p><i>CONNECTOR KS CAT6 SCH RJ45 8/8</i></p> <ul style="list-style-type: none"> - KS keystone fixing standard - CAT6 UTP toolless, RJ45 8/8 - in accordance with ISO/IEC 11801
------	---



KA16	<p>КОНЕКТОР KS CAT6S SCH RJ45 8/8</p> <ul style="list-style-type: none"> - KS модулен стандарт за закрепване - CAT6S STP без нужда от инструменти, RJ45 8/8 - в съответствие с ISO/IEC 11801 <p><i>CONNECTOR KS CAT6S SCH RJ45 8/8</i></p> <ul style="list-style-type: none"> - KS keystone fixing standard - CAT6S STP toolless, RJ45 8/8 - in accordance with ISO/IEC 11801
------	---



KA17	<p>КОНЕКТОР KS CAT6a SCH RJ45 8/8</p> <ul style="list-style-type: none"> - KS модулен стандарт за закрепване - CAT6a STP без нужда от инструменти, RJ45 8/8 - в съответствие с ISO/IEC 11801 <p><i>CONNECTOR KS CAT6a SCH RJ45 8/8</i></p> <ul style="list-style-type: none"> - KS keystone fixing standard - CAT6a STP toolless, RJ45 8/8 - in accordance with ISO/IEC 11801
------	---



КА18

КОНЕКТОР SLIM KS CAT6S SCH RJ45 8/8

- KS модулен стандарт за закрепване
- компактно изпълнение
- CAT6S STP без нужда от инструменти, RJ45 8/8
- в съответствие с ISO/IEC 11801
- също така е подходящ за двоен адаптор KE46

CONNECTOR SLIM KS CAT6S SCH RJ45 8/8

- *KS keystone fixing standard*
- *slim style*
- *CAT6S STP toolless, RJ45 8/8*
- *in accordance with ISO/IEC 11801*
- *suitable also for KE46 double adapter*



КА27

КОНЕКТОР KS HDMI

- KS модулен стандарт за закрепване
- само в комбинация с адаптер KM50
- HDMI/HDMI

CONNECTOR KS HDMI

- *KS keystone fixing standard*
- *only in combination with adapter KM50*
- *HDMI/HDMI*



КА28

КАБЕЛ KS HDMI

- KS модулен стандарт за закрепване
- само в комбинация с адаптер KM50
- HDMI/HDMI

CABLE KS HDMI

- *KS keystone fixing standard*
- *only in combination with adapter KM50*
- *HDMI/HDMI*



EM31



PW



тип type	описание description	технически данни technical data	размер size	цвет colour
EM12	ДИМЕР, ВЪРТЯЩ ТИП/ДВУПОСОЧЕН, RL 300W АКТИВЕН/ИНДУКТИВЕН ТОВАР <i>DIMMER ROTATIVE 2WAY</i>		1M	<input type="checkbox"/> PW снежнобял цвят <i>polar white</i> <input type="checkbox"/> MW бял матов цвят <i>matte white</i> <input type="checkbox"/> SB сензорен бутон, черен <i>soft touch black</i> <input type="checkbox"/> AT антрацит <i>anthracite</i> <input type="checkbox"/> ES сребрист <i>elox silver</i> <input type="checkbox"/> IW слонова кост <i>ivory white</i>
EM23	ДИМЕР, ВГРАДЕН, ЗА АКТИВЕН ТОВАР R (250 W), RC,RL 200VA <i>DIMMER INBOX</i>		/	<input type="checkbox"/> BL син цвят <i>blue</i> <input type="checkbox"/> RD червен <i>red</i> <input type="checkbox"/> GR зелен <i>green</i> <input type="checkbox"/> OR оранжев <i>orange</i> <input type="checkbox"/> RG червен/зелен <i>red/green</i>

ДИМЕР, ВЪРТЯЩ ТИП/ДВУПОСОЧЕН, АКТИВЕН/ИНДУКТИВЕН ТОВАР 300 W 1M



- EM12PW
- EM12MW
- EM12SB
- EM12AT
- EM12ES
- EM12IW

- управление чрез завъртане, с двупосочен ключ
- активен/индуктивен товар, 40 W – 300 W
- захранващо напрежение 230 V~ 50 Hz
- възможна е комбинация с двупосочен ключ
- допуска се инсталиране на няколко устройства заедно в една конзола само ако общият им максимален товар не превишава максималната мощност на един димер
- една верига позволява използване само на един димер
- без вграден предпазител – трябва да се използва външен предпазител
- в съответствие с EN 60669-1
- винтови контакти – 1,5-2,5 mm²
- интегрирана светодиодна индикация за нивото на димиране



DIMMER ROTATIVE/2WAY RL 300W 1M

- rotation control with 2-way switch
- load RL, 40W - 300W
- supply voltage 230V~ 50Hz
- 2-way switch combination is possible
- installing several devices together in one box is only permitted if their total maximum load does not exceed the maximum power of a single dimmer
- one circuit allows the use of only one dimmer
- no built-in fuse – external fuse must be used
- in accordance with EN 60669-1
- screw contacts - 1.5-2.5mm²
- integrated LED indication of dimming level

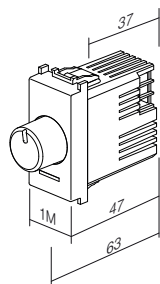

ДИМЕР, ВЪРТЯЩ ТИП/ДВУПОСОЧЕН, ЗА СВЕТОДИОДНО ОСВЕТЛЕНИЕ 60 W 1M



- EM13PW
- EM13MW
- EM13SB
- EM13AT
- EM13ES
- EM13IW

- управление чрез завъртане, с двупосочен ключ
- товар: светодиодно осветление, 0 – 60 W (макс. 6 димируеми светодиодни лампи)
GLS, 0 – 60 W
- захранващо напрежение 230 V~ 50 Hz
- възможна е комбинация с двупосочен ключ
- допуска се инсталиране на няколко устройства заедно в една конзола само ако общият им максимален товар не превишава максималната мощност на един димер
- една верига позволява използване само на един димер
- без вграден предпазител – трябва да се използва външен предпазител
- в съответствие с IEC60669-2-1
- винтови контакти – 1,5-2,5 mm²

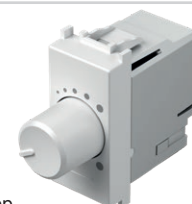

DIMMER ROTATIVE/2WAY LED 60W 1M

- rotation control with 2-way switch
- loads: LED, 0 – 60W (max. 6 dimmable LED lamps)
GLS, 0 – 60W
- supply voltage 230V~ 50Hz
- 2-way switch combination is possible
- installing several devices together in one box is only permitted if their total maximum load does not exceed the maximum power of a single dimmer
- one circuit allows the use of only one dimmer
- no built-in fuse – external fuse must be used
- in accordance with IEC60669-2-1
- screw contacts - 1.5-2.5mm²

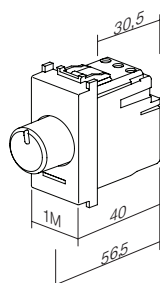

ДИМЕР, ВЪРТЯЩ ТИП/ДВУПОСОЧЕН, ЗА СВЕТОДИОДНО ОСВЕТЛЕНИЕ 180W 1M



- EM14PW
- EM14MW
- EM14SB
- EM14AT
- EM14ES
- EM14IW

- управление чрез завъртане, с двупосочен ключ
- товар: светодиодно осветление, 0 – 180 W (макс. 20 димируеми светодиодни лампи) GLS, 0 – 180 W
- захранващо напрежение 230 V~ 50 Hz
- възможна е комбинация с двупосочен ключ
- допуска се инсталиране на няколко устройства заедно в една конзола само ако общият им максимален товар не превишава максималната мощност на един димер
- една верига позволява използване само на един димер
- без вграден предпазител – трябва да се използва външен предпазител
- в съответствие с IEC60669-2-1
- винтови контакти – 1,5-2,5 mm²

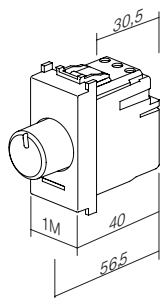

DIMMER ROTATIVE/2WAY LED 180W 1M

- rotation control with 2-way switch
- loads:
 - LED, 0 – 180W (max. 20 dimmable LED lamps)
 - GLS, 0 – 180W
- supply voltage 230V~ 50Hz
- 2-way switch combination is possible
- installing several devices together in one box is only permitted if their total maximum load does not exceed the maximum power of a single dimmer
- one circuit allows the use of only one dimmer
- no built-in fuse – external fuse must be used
- in accordance with IEC60669-2-1
- screw contacts - 1.5-2.5mm²

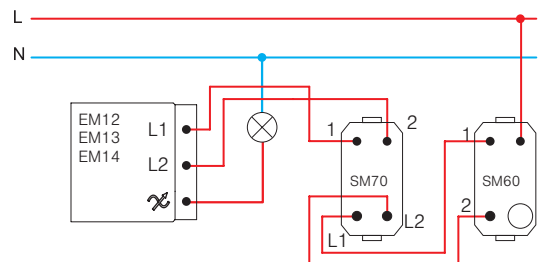
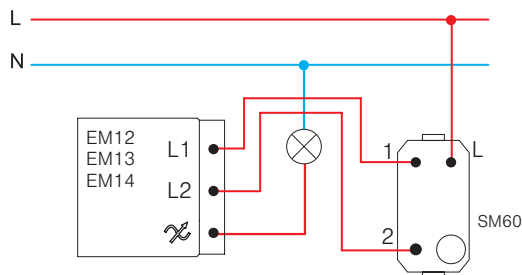
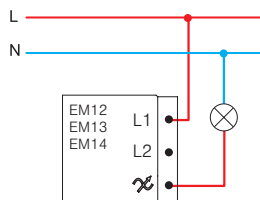

ДИМЕР, ВЪРТЯЩ ТИП, R 250W 1M



- EM15PW
- EM15MW
- EM15SB
- EM15AT
- EM15ES
- EM15IW

- управление чрез завъртане, без ключ
- активен товар, 40 W – 250 W
- захранващо напрежение 230 V~ 50 Hz
- не е възможна комбинация с двупосочен ключ
- не се допуска комбинация с допълнителни димери
- в съответствие с EN 60669-1
- винтови контакти 1,5 - 2,5 mm²
- светодиодна индикация

DIMMER ROTATIVE R 250W 1M

- rotation control without switch
- load R, 40W - 250W
- supply voltage 230V~ 50Hz
- 2-way switch combination is not possible
- more dimmers combination is not allowed
- in accordance with EN 60669-1
- screw contacts 1.5-2.5mm²
- LED indication

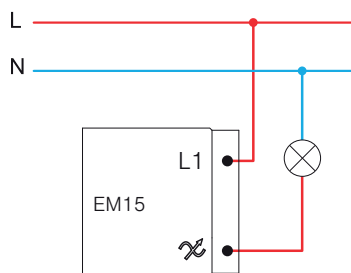
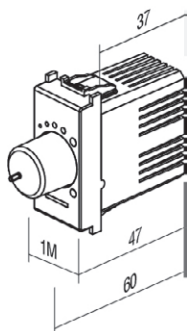

1 – 10 V ДИМЕР, ВЪРТЯЩ ТИП, ДВУПОСОЧЕН



- EM16PW
- EM16MW
- EM16SB
- EM16AT
- EM16ES
- EM16IW

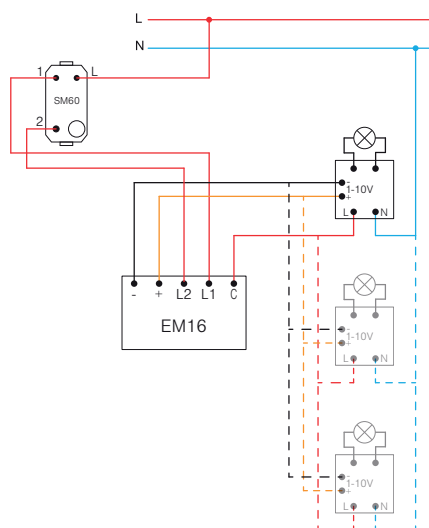
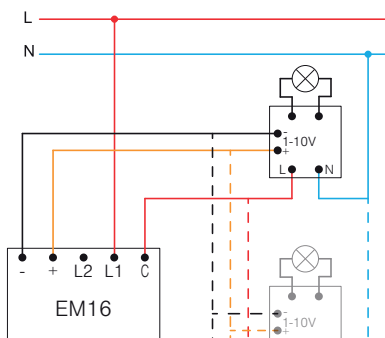
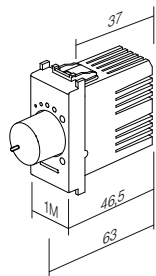

- номинално работно напрежение: 10 V DC
- минимално работно напрежение: 0,7 V DC
- диапазон на димиране: 0,7% – 100% (в зависимост от драйвера и товара)
- минимален понорен ток: 0,1 mA
- максимален понорен ток: 120 mA
- максимална консумация: 0,35 W
- защита срещу свръхнапрежение: 15,8 V DC до 250 mA (несменяема)
- най-голям пулсов ток: 3 A DC
- вид товар: 0 – 10 V, 1 – 10 V и PWM
- тип на ключа: механичен: натисни включи/изключи
- проводник на нустралата: не е необходим
- номинално работно напрежение: 100 – 240 V AC, 50 – 60 Hz
- максимален моментен ток: 10 A
- максимален работен ток: 8 A
- максимално натоварване (при 230 VAC): 1800 VA (1800 x pf = max. W)
- изоляционно съпротивление: > 100 MΩ при 250 V AC
- защита срещу свръхнапрежение и късо съединение: 10 A, 350 V AC (несменяема)
- ъгъл на ротация: 270° ± 5°
- работна температура: -5 до 40° C
- температура на съхранение: -30 до 80° C
- максимална температура на рамката: 65° C
- максимална влажност: 90% (без кондензация)
- EMC и имунност: CISPR 15(2008), IEC 61547
- LVD: IEC 60669-1:2017, IEC 60669-2-1:2015

1-10 V DIMMER ROTARY TOGGLE

- nominal operating voltage: 10 VDC
- minimum operating voltage: 0.7 VDC
- dimming range: 0.7% – 100% (depending on power supply and loads)
- minimum sink current: 0.1 mA
- maximum sink current: 120 mA
- maximum consumption: 0.35 W
- surge protection: 15.8 VDC up to 250 mA (not replaceable)
- maximum pulse current: 3 ADC
- load types: 0-10 V, 1–10 V and PWM
- switch type: mechanical: push on/off
- zero cable: not required
- nominal operating voltage: 100–240 VAC, 50–60 Hz
- maximum instantaneous current: 10 A
- maximum operating current: 8 A
- maximum load (at 230 VAC): 1800 VA (1800 x pf = max. W)
- isolation resistance: > 100 MΩ at 250 VAC
- surge protection and Short-circuit protection: 10 A, 350 VAC (not replaceable)
- rotation angle: 270° ± 5°
- operating temperature: -5 to 40°C
- storing temperature: -30 to 80°C
- maximum housing temperature: 65°C
- maximum humidity: 90% (no condensation)
- EMC & immunity: CISPR 15(2008), IEC 61547
- LVD: IEC 60669-1:2017, IEC 60669-2-1:2015

ДИМЕР, ВГРАДЕН, ЗА АКТИВЕН ТОВАР (250 W), (АКТИВЕН/КАПАЦИТИВЕН, АКТИВЕН/ИНДУКТИВЕН ТОВАР 200 VA)



EM23

- вграден, управлява се от външен бутон
- активен/индуктивен/капацитивен товар 15-250 W или 15-200 VA
- захранващо напрежение 230 V~ 50 Hz
- възможни са комбинации от няколко бутона
- не се допуска комбинация с допълнителни димери
- памет за интензивността на осветлението
- функция за плавно стартиране/спиране
- »leading edge«
- в съответствие с EN60669, EN60950, EN 61000, ETSI EN 300 220-1, ETSI EN 300 220-2
- винтови контакти за проводници 2,5 mm²

DIMMER INBOX R (250 W), (RC, RL 200 VA)

- inbox, controlled by external push button
- load RLC 15-250W or 15-200 VA
- supply voltage 230V~ 50Hz
- several push-buttons combinations are possible
- more dimmers combination is not allowed
- light intensity memory
- soft start/stop function
- »leading edge«
- in accordance with EN60669, EN60950, EN 61000, ETSI EN 300 220-1, ETSI EN 300 220-2
- screw contacts to wires 2,5 mm²

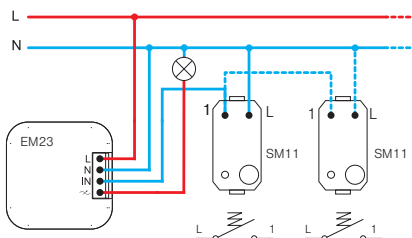
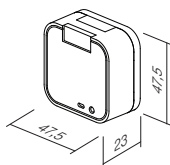

УПРАВЛЯВАЩ модул MZC за EM18

EM17

- свържете MZC, съгласно схемата за свързване.
- възможно свързване с няколко бутона.
- монтаж само на едно устройство в една конзола
- само за вътрешно ползване
- захранване: 230 V~ 50Hz
- максимално съпротивление на жиците: 50 kΩ
- максимален ток през част MZC: 10 mA
- брой димери на MZC: 1-4
- максимален брой MZC в мрежата: ограничено до предпазителя в движението на тока- температура при функциониране: -5 °C до 45 °C
- температура на складиране: -30 °C до 80 °C
- максимална влажност: 90% (без кондензиране)
- размери на корпуса: 36 x 36 x 12 mm.

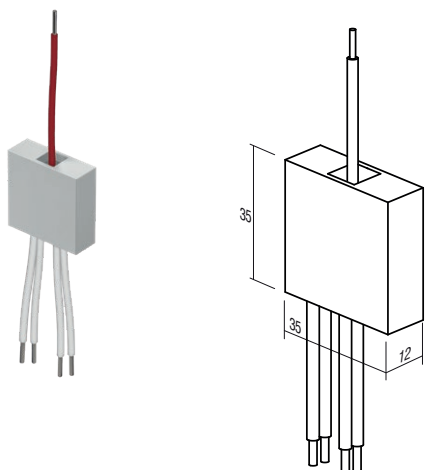

MZC CONTROL Module for EM18

- Connect the MZC according to the wiring diagram.
- Possible wiring with several push buttons.
- Only one device installation per mounting box.
- For indoor use only.
- Power supply: 230V~ 50Hz
- Max. cable resistance: 50kΩ
- Max. current per MZC unit: 10mA
- Number of dimmers on MZC: 1-4
- Max. number of MZC in the wiring: limited to the fuse in the circuit
- Operating temperature: -5°C to 45°C
- Storage temperature: -30°C to 80°C
- Max. humidity: 90% (no condensation)
- Casing dimensions: 36x36x12 mm

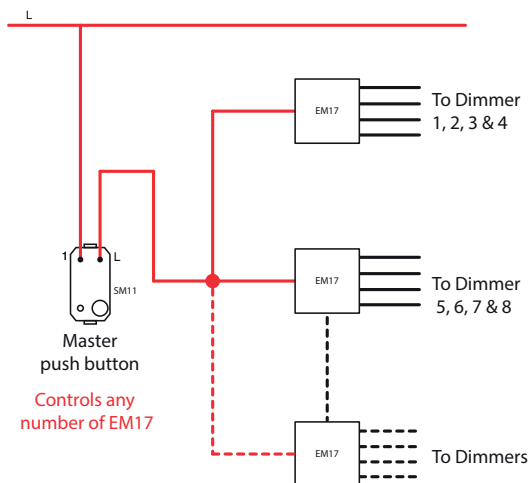
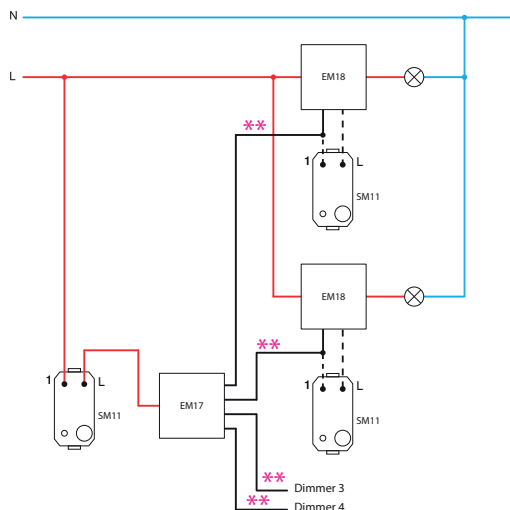

ДИМЕРНО УСТРОЙСТВО ЗА СВЕТОДИОДИ 250W

EM18

- вградена кутия, управлява се външно чрез бутон
- за индуктивен и капацитивен товар
- захранващо напрежение 230 V~ 50 Hz
- възможни са няколко комбинации с бутони
- функция за запаметяване на последната настройка, освен при прекъсване на захранването
- функция за плавен старт/стоп
- контрол на минималния интензитет
- само един димер за стенна кутия
- само за употреба на закрито
- в съответствие с EN 60669-1 и EN 60669-2-1

DIMMER INBOX LED 250W

- inbox, controlled by external push button
- for leading or trailing edge
- supply voltage 230V~ 50Hz
- several push-buttons combinations is possible
- memory function of the last setting, except in the case of a power failure
- soft start / stop function
- minimum intensity control
- only one dimmer per wall box
- only for indoor usage
- in accordance with EN 60669-1 and EN 60669-2-1

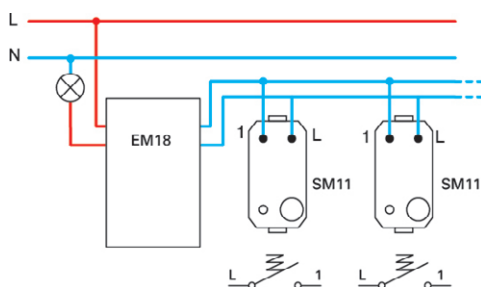
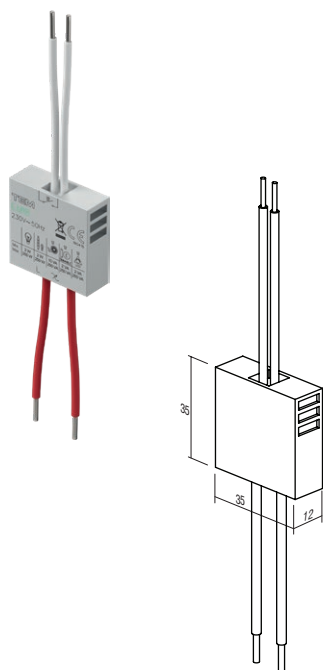

ДИМЕРНО УСТРОЙСТВО ЗА СВЕТОДИОДИ, ПОСТОЯНЕН ТОК 96 W



EM19

- вградена кутия, управлява се външно чрез бутон
- за употреба със светодиодни драйвери с постоянно напрежение и някои светодиодни драйвери с постоянен ток, 9 – 48 V DC, макс. 96 W (подходящо и за светодиодни ленти)
- не е подходящо за употреба при индуктивен товар
- възможни са комбинации от няколко бутона и няколко димера
- функция за запаметяване на последната настройка, освен при прекъсване на захранването
- функция за плавен старт/стоп
- само един димер за стенна кутия
- само за употреба на закрито

DIMMER INBOX DC LED 96W

- inbox, controlled by external push button
- for use with constant voltage LED drivers and some constant current LED drivers, 9-48V DC, max 96W (also for LED strips)
- not for use with inductive loads
- several push-buttons combinations and several dimmers is possible
- memory function of the last setting, except in the case of a power failure
- soft start / stop function
- only one dimmer per wall box
- only for indoor usage

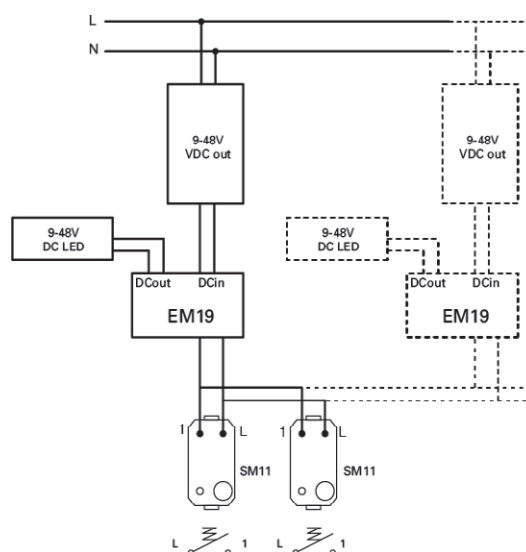
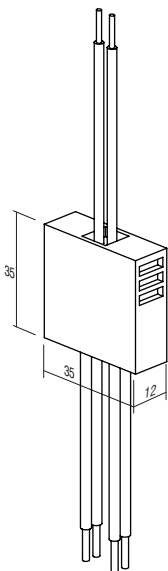

ВНИМАНИЕ!

Ако няколко димера са свързани в една конзола, намалете допустимата обща максимална мощност с 10 % за всеки димер.

ATTENTION!

If more dimmers are connected in one box reduce maximum common power for 10% for each dimmer.

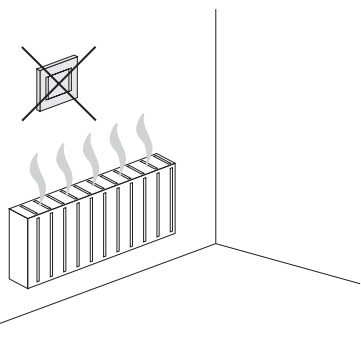

EM15 (40÷250W)

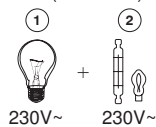

EM12 (40÷300W)

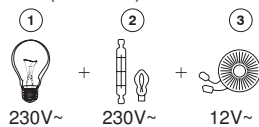

EM13 (0÷60W), EM14 (0÷180W), EM23 (15÷250W, 15÷200VA),

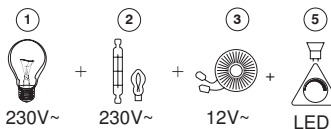

- 1 – лампа с нажежаема жичка / incandescent lamp
- 2 – халогенна лампа / halogen lamp
- 3 – класически трансформатор / classical transformer
- 4 – Димиращ електронен трансформатор / dimmable electronic transformer
- 5 – димируема светодиодна лампа / dimmable LED lamp

EM18 (2÷250VA)

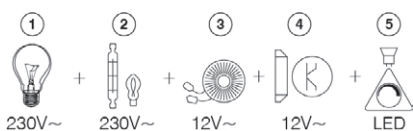

КЛЮЧУНИВЕРСАЛЕН ДИМЕР ЗА АКТИВЕН/ИНДУКТИВЕН/КАПАЦИТИВЕН ТОВАР 0-300 W 2M

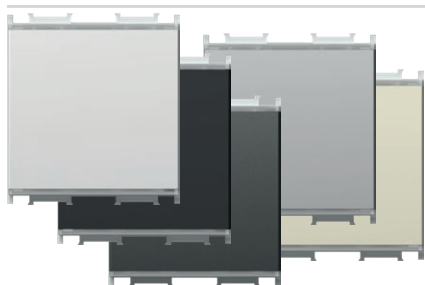

- EM25PW
- EM25MW
- EM25SB
- EM25AT
- EM25ES
- EM25IW



TOUCH EM25 е управляван от микропроцесор електронен димер за осветление. Той служи за ключ и димер за лампи, позволяващи димиране, и за някои видове лампи, не позволяващи димиране. Интегрираният микропроцесор автоматично идентифицира типа на лампата и напаса работния режим. Благодарение на интегрираната функция за запаметяване се запомня нивото на димиране след изключване. Функцията за главно стартиране/спиране удължава експлоатационния живот на лампите. В бутона е вградена елегантна LED индикация – с възможност за избирането на цвета и настройването на интензитета. Като опция е възможно свързване на максимално 5 допълнителни управляващи устройства EM26 («подчинени устройства») към EM25.

TOUCH EM25 is microprocessor controlled electronic light dimmer. It serves as switch and dimmer for dimmable and some of non-dimmable lamps. Integrated microprocessor automatically identifies the type of lamp and adjusts the operating mode. It remembers the level of dimming after switching off due to integrated memory function. Soft-start function extends the lamp service life. An elegant LED indication is integrated into the button and the option of choosing a colour and intensity level is provided. Optionally one can connect of up to 5 additional control tasters EM26 («slave»).

- универсален електронен димер за включване, изключване и димиране на всички лампи, позволяващи димиране (класически, халогенни, светодиодни, газоразрядни...) и някои видове лампи, не позволяващи димиране
- автоматично определяне на типа на лампата и регулиране на работния режим
- намалена консумация на енергия
- функцията за плавно стартиране/спиране удължава живота на лампите
- управление чрез вградени микроклучета
- съдържа функция за запаметяване – запомня силата на осветлението в момента на изключване
- допълнително може да се свържат до пет (5) устройства за управление EM26
- не е възможно свързване с двупосочен ключ
- вградена защита против късо съединение, прегряване и претоварване
- захранващо напрежение 230 V~ 50 Hz
- Вградена елегантна LED индикация, с възможност за настройване на цвета и интензитета.
- замяна на обикновен ключ е възможно при двупроводно свързване (1)
- замяна на обикновен ключ е възможно при двупроводно свързване (2)
- в съответствие с EN 60669-1 и EN 60669-2-1
- винтови контакти за проводници 1,5 mm² (макс. въртящ момент за притягане 0,4 Nm)

SWITCH / DIMMER UNIVERSAL RLC 0-300W 2M

- universal electronic dimmer for ON/OFF switching and dimming of all dimmable lamps (classical, halogen, LED, CFL, ...) and some non-dimmable lamps
- automatic detection of lamp type and adjustment of operating mode
- reduction of energy consumption
- soft start function extends life of lamps
- controlled by build-in micro switches
- memory function included – memorizes brightness on turn-off
- up to five (5) additional control units EM26 can be connected
- connection with 2-way switch is not possible
- build-in short-circuit, overheating and overload protection
- supply voltage 230V~ 50Hz
- an elegant integrated LED indication with the option of setting colour and intensity.
- replacement of classical switch is possible at two-wire connection⁽¹⁾
- full functionality is achieved at three-wire connection⁽²⁾
- in accordance with EN 60669-1 and EN 60669-2-1
- screw contacts 1.5mm² (max. tightening torque 0.4Nm)

(1) двупроводно свързване
two-wire connection

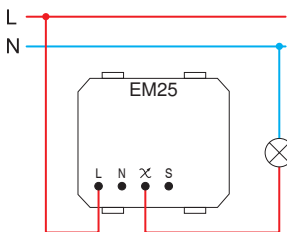

(2) трипроводно свързване
three-wire connection

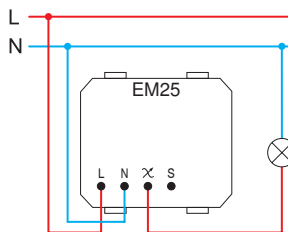

- двупроводното свързване дава възможност за димиране на лампи, позволяващи димиране
- two-wire connection allows dimming of dimmable lamps

- трипроводното свързване дава възможност за димиране на лампи, позволяващи димиране, и на някои видове не позволяващи димиране светодиодни и газоразрядни лампи
- three-wire connection allows dimming of dimmable lamps and some of non-dimmable LED and CFL lamps

	1	2	5	6	7
Min.	40 W	40 W	40 VA	40 VA	40 VA
Max.	300 W	300 W	300 VA	100 VA	100 VA
	(F)	(F)	(F)		

	1	2	4	6	7	8	9
Min.	0 W	0 W	0 VA	0 VA	0 VA	0 VA	0 VA
Max.	300 W	300 W	120 VA	120 VA	120 VA	120 VA	120 VA
	(F)	(F)	(F)			(F)	(F)

- 1 – лампа с нажежаема жичка / incandescent lamp
- 2 – халогенна лампа / halogen lamp

- 4 – Димиращ електронен трансформатор / dimmable electronic transformer
- 5 – класически трансформатор / classical transformer

- 6 – икономия на енергия при димиране на газоразрядна лампа / dimmable energy saving CFL lamp
- 7 – димируема светодиодна лампа / dimmable LED lamp

- 8 – без икономия на енергия при димиране на газоразрядна лампа / non-dimmable energy saving CFL lamp
- 9 – недимируема светодиодна лампа / non-dimmable LED lamp

бележки / remarks

- (F) филтър EM27
- препоръчва се използване на филтър EM27 / it is recommended to use filter EM27
- всички управлявани лампи трябва да са от един тип / all controlled lamps must be the same
- таблицата за товара е валидна за лампи с коефициент на мощност PF>0,5 / table of loads is valid for lamps with power factor PF>0.5

- включване, изключване и димиране на лампа /
on / off swithcing and dimming of lamp

избор на цвят и настройка на интензитета на LED частта /
LED unit colour and intensity level selection

★ функция за „нулиране“ (RESET) /
“RESET” function

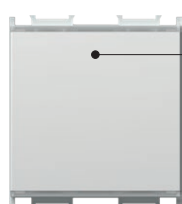

включване/изключване
кратковременно
натискане
on / off
short press

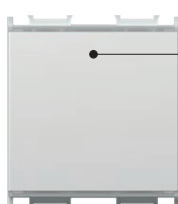

изключване на лампата
кратковременно натискане
lamp off
short press



изключване на лампата
кратковременно натискане
lamp off
short press

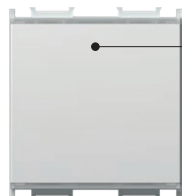

усилване на димирането
продължително натискане
dimming up
long press

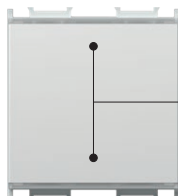

едновременно натискане ~3 сек
интегрираният светодиод примигва
3 пъти
simultaneous press ~3s
integrated LED blinks 3
times



едновременно натискане ~3 сек
интегрираният светодиод примигва
3 пъти
simultaneous press ~3s
integrated LED blinks 3
times

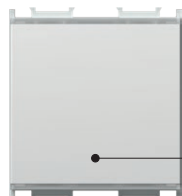

намаляване на
димирането
продължително
натискане
dimming down
long press



избиране на цвят
кратковременно натискане
colour selection
short press

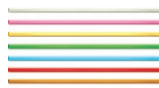

едновременно натискане ~5 сек
интегрираният светодиод примигва
5 пъти
re-simultaneous press ~5s
integrated LED blinks 5
times

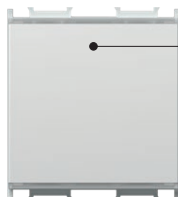

осветяване на вграденя LED
по-продължително натискане
integrated LED dimming up
long press

★ - препоръчва се при инсталиране на димер и смяна на лампи
- задължително, ако се използват лампи, не позволяващи димиране
- функцията за „нулиране“ (RESET) не е налична при използване на
двупроводно свързване
- възможно е само за EM25



степенуване на интензивността на вградената
LED част
по-продължително натискане
intensity escalation of the
integrated LED unit
long press



- it is recommended at dimmer installation
and lamp replacement
- mandatory when using non-dimmable lamps
- “RESET” function is not possible when using
two-wire connection
- only possible on EM25

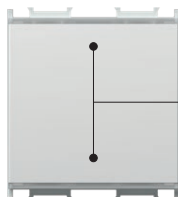

запаметяване на настройката – едновременно
кратковременно натискане
интегрираният светодиод примигва 3 пъти
settings saving - simultaneous short
press
integrated LED blinks 3 times

предупреждения във връзка с инсталирането /
installation precautions

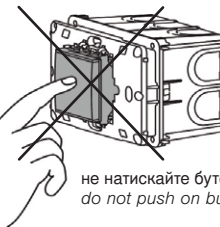
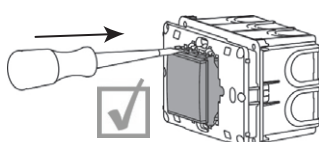
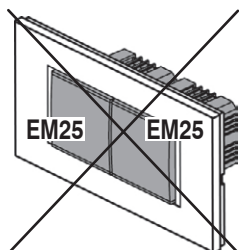
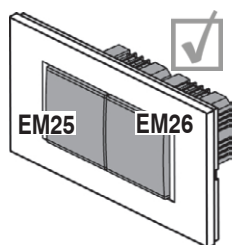

не натискайте бутона по време на монтажа
do not push on button during mounting



- EM26PW
- EM26MW
- EM26SB
- EM26AT
- EM26ES
- EM26IW

БУТОННО УСТРОЙСТВО ЗА УПРАВЛЕНИЕ 2M

- свързано към универсален димер EM25 дава възможност за управление на лампи със същата функционалност (максимално до) като EM25
- захранващо напрежение 230 V~ 50 Hz
- в съответствие с EN 60669-1 и EN 60669-2-1
- винтови контакти за проводници 1,5 mm²
- (макс. въртящ момент за притягане 0,4 Nm)

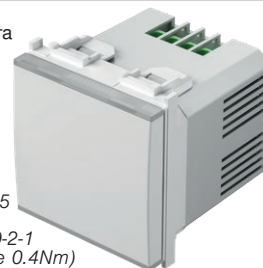

PUSH-BUTTON CONTROL UNIT 2M

- connected to universal dimmer EM25 allows controlling of lamps with same functionality as EM25
- supply voltage 230V~ 50Hz
- in accordance with EN 60669-1 and EN 60669-2-1
- screw contacts 1.5mm² (max. tightening torque 0.4Nm)

(1)двупроводно свързване
two-wire connection

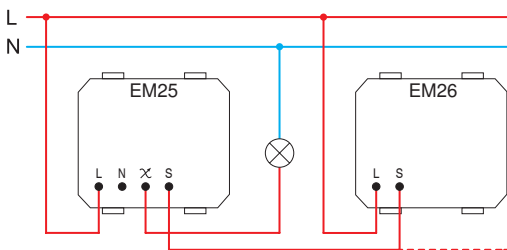

- двупроводното свързване дава възможност за димиране на лампи, позволяващи димиране
- при двупроводно свързване всяко допълнително устройство за управление увеличава минималния товар с 25 W

- two-wire connection allows dimming of dimmable lamps
- in a two-wire connection each additional control unit increases the minimum load by 25W

(2)триповодно свързване
three-wire connection

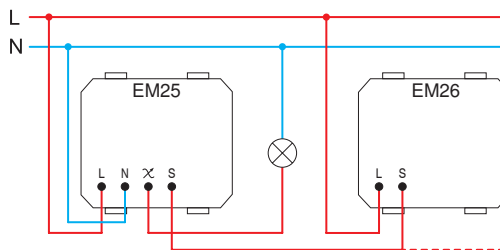

- триповодното свързване дава възможност за димиране на лампи, позволяващи димиране, и на някои видове не позволяващи димиране светодиодни и газоразрядни лампи
- three-wire connection allows dimming of dimmable lamps and some of non-dimmable LED and CFL lamps



EM27

ЧЕСТОТЕН ФИЛТЪР

- честотен филтър за EM25
- изображението е символично

FREQUENCY FILTER

- frequency filter for EM25
- image is symbolic

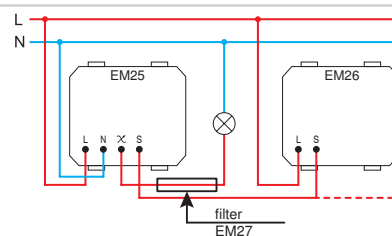

КОМПЛЕКТ КЛЮЧНИ УНИВЕРСАЛЕН ДИМЕР ЗА АКТИВНИ И ИНДУКТИВНИ КАПАЦИТИВНИ ТОВАР 0-300 W 2M PP OL20

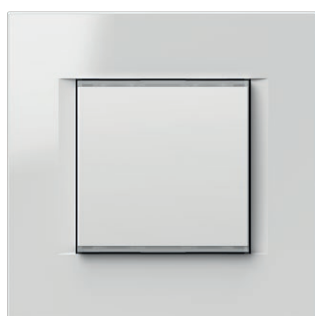

□ EM25PPOL20

- комплектът съдържа димер EM25, монтажна рамка 2M и панел LINE 2M PW
- за технически подробности вижте EM25

SET SWITCH / DIMMER UNIVERSAL RLC 0-300W 2M PP OL20

- set includes dimmer EM25, mounting frame 2M and cover plate LINE 2M PW
- for technical details see EM25



2M = 45 x 45

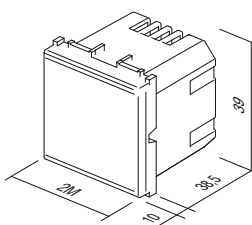

EM25
EM26

КЛЮЧ IR 5 A 230 V~ 1M



- EM31PW
- EM31MW
- EM31SB
- EM31AT
- EM31ES
- EM31IW

- инфрачервен ключ IR
- захранващо напрежение: 230 V~ ±10 % 50 Hz
- реле: 5 A/250 V~ (нулевата стойност)
- клас на защита: IP40
- сечение на проводниците при контакта 0,75 - 2,5 mm²
- ъгъл на откриване: до 110° при 20° C
- разстояние на откриване: прил. 8 m при 20° C
- регулируема продължителност: от прил. 5 сек до 12 мин
- регулиране на яркостта на осветлението: от прил. 5 до 200 лукса
- работна температура: от 0° C до +40° C
- не е подходящо за инсталиране в конзоли с дълбочина 45 mm и конзоли за външен монтаж CUBO IP20
- само за използване на закрито



IR SWITCH 5A 230V~ 1M

- IR infrared switch
- supply voltage: 230V~ ±10 % 50Hz
- relay: 5A / 250V~ (zero crossing)
- protection rating: IP40
- cross-section of wires at the contact terminal: 0.75 - 2.5 mm²
- detection angle: up to 110° at 20°C
- detection area: approx. 8 m at 20°C
- adjustability of duration: from approx. 5 s to 12 min
- adjustability of brightness: from approx. 5 to 200 LUX
- operating temperature: from 0°C to +40°C
- not suitable for installation in 45 mm deep boxes and surface mount box CUBO IP20
- only for indoor usage

КЛЮЧ IR 5 A 230V~ 2M

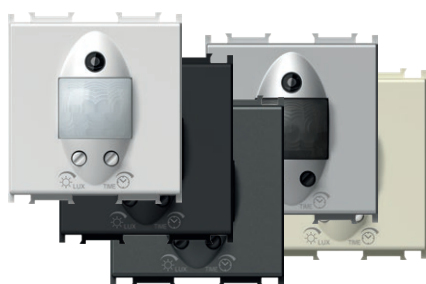

- EM32PW
- EM32MW
- EM32SB
- EM32AT
- EM32ES
- EM32IW

- инфрачервен ключ IR
- захранващо напрежение: 230 V~ ±10 % 50 Hz
- реле: 5 A/250 V~ (нулевата стойност)
- клас на защита: IP40
- сечение на проводниците при контакта 0,75 - 2,5 mm²
- ъгъл на откриване: до 110° при 20° C
- разстояние на откриване: прил. 8 m при 20° C
- регулируема продължителност: от прил. 5 сек до 12 мин
- регулиране на яркостта на осветлението: от прил. 5 до 200 лукса
- работна температура: от 0° C до +40° C
- не е подходящо за инсталиране в конзоли с дълбочина 45 mm и конзоли за външен монтаж CUBO IP20
- само за използване на закрито



IR SWITCH 5A 230V~ 2M

- IR infrared switch
- supply voltage: 230V~ ±10 % 50Hz
- relay: 5A / 250V~ (zero crossing)
- protection rating: IP40
- cross-section of wires at the contact terminal: 0.75 - 2.5 mm²
- detection angle: up to 110° at 20°C
- detection area: approx. 8 m at 20°C
- adjustability of duration: from approx. 5 s to 12 min
- adjustability of brightness: from approx. 5 to 200 LUX
- operating temperature: from 0°C to +40°C
- not suitable for installation in 45 mm deep boxes and surface mount box CUBO IP20
- only for indoor usage

обхват на откриване /
detection range

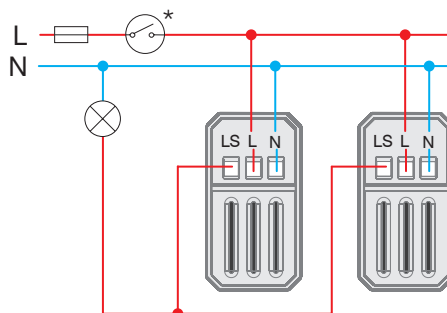
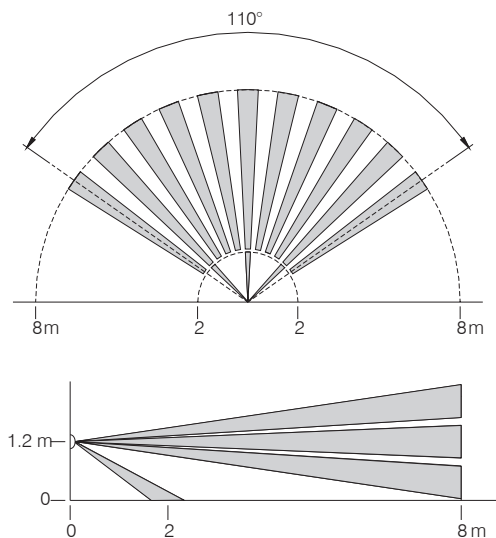

E L E C T R O N I C S E M

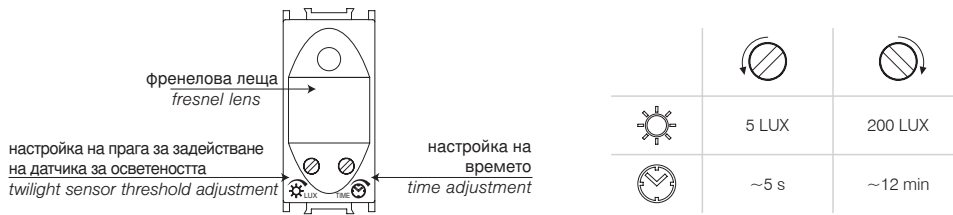
настройка на времето и осветеността C
time and twilight adjustment

	1	2	3	4	5	6	7	8
Min.	1 W	1 W		1 VA	1 W	1 W	1 VA	1 VA
Max.	800 W	800 W	5A	6x20 VA	6x36 W	4x36 W (20μF)	6x23 VA	6x20 VA

1 – лампа с нажежаема жичка /
incandescent lamp

2 – халогенна лампа /
halogen lamp

3 – съпротивителен нагревателен елемент /
resistive heating element

4 – електронен преобразовател /
electronic transformer

5 – флуоресцентна пюра (версия 1) /
fluorescent tube (version 1)

6 – флуоресцентна пюра (версия 2) /
fluorescent tube (version 2)

7 – енергоспестяваща газоразрядна лампа /
energy saving CFL lamp

8 – светодиодна лампа /
LED lamp

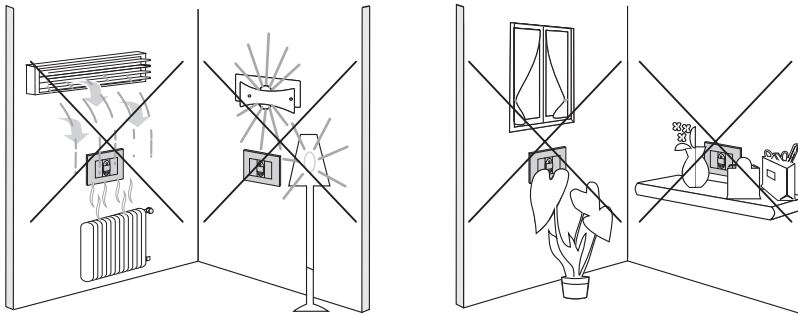
внимание /
attention

1м = 22,5 x 45
2м = 45 x 45

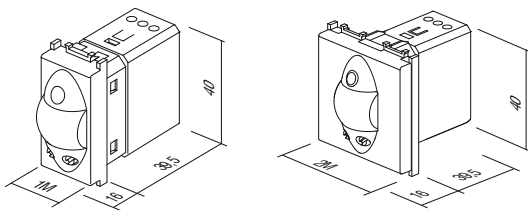

ТЕРМОСТАТ ОСНОВЕН 6A 230V~ 2M



- EM37PW
- EM37SB
- EM37AT
- EM37ES
- EM37IW

- електронен термостат, базов
- работен режим: отопление/охлаждане/изключване
- захранващо напрежение: 230 VAC, 50 Hz
- изход: 6(2) A, 230 VAC, релееен ключ
- обхват на регулиране: +10° C до +30° C
- хистерезис: ±0,5° C, ED = 20 мин
- защита против замръзване (режим на отопление): +6° C
- защита против прегряване (режим на охлаждане): +32° C
- функция ECO за намаляване на температурата с 3° C за 6 часа в режим на отопление и повишаване на температурата с 3° C за 6 часа в режим на охлаждане
- адаптивна функция ECO function, ежедневно автоматично в едно и също време намаляване на температурата с 3° C за 6 часа в режим на отопление и повишаване на температурата с 3° C за 6 часа в режим на охлаждане
- опция за включване на работния режим ECO чрез външно задействане по отделен вход
- LED сигнализация на функционирането
- не е подходящо за електрическо подово отопление
- винтови контакти макс. 2,5 mm²
- в съответствие с Директивата за ниско напрежение, Директивата за EMC, стандарти EN60730-1 и EN60730-2-9
- за правилно функциониране препоръчваме да се инсталира в единична отделна конзола, отделно от устройства, излъчващи топлина
- работна температура: 5 ÷ 35° C
- температура на съхраняване: -20 ÷ 50° C



Термостатът е предназначен за регулиране на температурата в помещението. Термостатът предоставя два работни режима – отопление или охлаждане. Той има инсталирани функции за безопасност – за защита против замръзване (режим на отопление) и - защита против прегряване (режим на охлаждане). Функционирането се сигнализира с помощта на LED сигнализация. Настройката на термостата се осъществява с въртящ се регулатор за задаване на температурата и с други сензорни капацитивни бутони.

The thermostat is intended for regulating temperature in a room. A thermostat enables two modes of operation – heating or cooling. It has safety functions installed for protection against freezing (heating mode) and protection against overheating (cooling mode). The operation is indicated via LED signaling. Thermostat setup is performed with the help of a rotary button for setting the temperature and with other capacitive touch buttons.

THERMOSTAT BASIC 6A 230 V ~ 2M

- electronic thermostat, basic
- operation mode: heating/cooling/turn off
- power supply: 230 VAC, 50 Hz
- output: 6(2) A, 230 VAC, relay switch
- regulation range: +10 °C to +30 °C
- hysteresis: ±0.5 °C, ED = 20min
- anti-freeze protection (heating mode): +6 °C
- overheating protection (cooling mode): +32 °C
- ECO function for lowering the temperature by 3 °C for 6 hours in the heating mode and raising temperature by 3 °C for 6 hours in the cooling mode
- adaptive ECO function, automatically every day at the same time lowers the temperature by 3 °C for 6 hours in the heating mode and raises temperature by 3 °C for 6 hours in the cooling mode
- option to turn on the ECO operating mode by external trigger via a separate input
- LED signalling of the operation
- not suitable for electrical floor heating
- screw contacts max. 2.5 mm²
- in accordance with the LV Directive, the EMC Directive, standards EN60730-1 and EN60730-2-9
- for correct operation, we recommend installing in an independent single box, separate from devices that generate heat
- operating temperature: 5 ÷ 35 °C
- storage temperature: -20 ÷ 50 °C

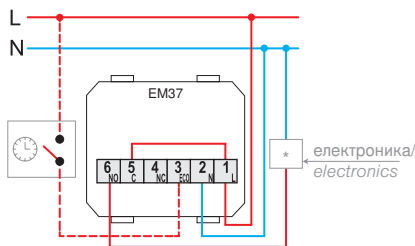

циркуляционна помпа, горелка (директно свързване), термоелектрическо задвижване/
circulation pump, burner (direct connection)
thermoelectric drive

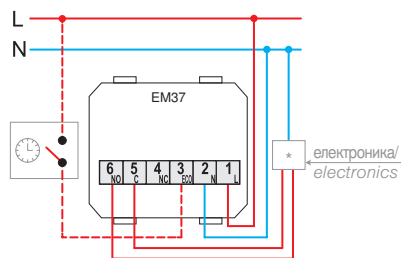

бойлер, помпа за отоплението, горелка (управляващ вход T1/T2) /
boiler, heat pump, burner (control input T1/T2)

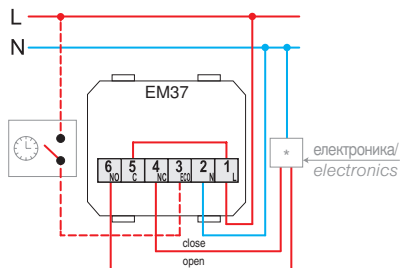

задвижване с мотор (ограничено използване с подово отопление) /
motor drive (limited use with underfloor heating)

настройка на функцията и температурата
function and temperature adjustment

бутон за избиране на функция и светодиоден индикатор за състоянието:
червен: отопление
син: климатизация
без светещ индикатор: изключено

function selection button and LED status signalization:
red: heating
blue: air conditioning
no light: switched off

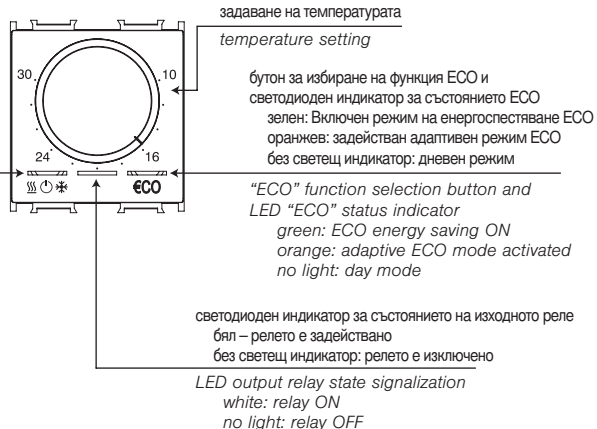

внимание/
attention

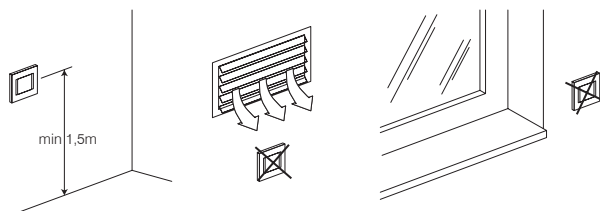

ТЕРМОСТАТ ЗА ОТОПЛЕНИЕ 5(2) A 230 V~ 2M

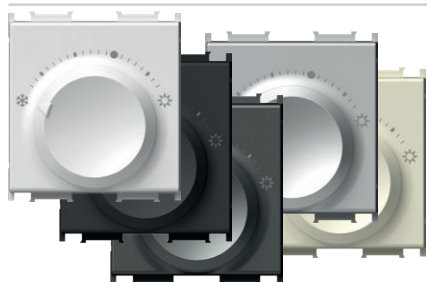

- EM38PW
- EM38MW
- EM38SB
- EM38AT
- EM38ES
- EM38IW

- режим на работа: отопление
- захранване: 230 VAC, 50 Hz
- импулс на напрежение: 4 kV
- консумация на енергия: < 0,5 W
- изход: 2 A (макс. 5 A); 230 VAC, 50 Hz
- изходен порт: NO (макс. 10 актуатора)
- зона на регулация: +5° C до +30° C
- защита против замръзване: +5° C
- хистерезис: 0,5 K
- защита: IP30
- вид на сензора: Bimetal
- вид на електрическия изход: пружинни клеми
- вид на проводниците: 0,75 – 1,5 кв. мм (с гъвкава жица); 1,0 – 2,5 кв. мм (с твърда жица)
- в съответствие с Директива DIN EN 60730



HEATING THERMOSTAT 5(2)A 230V~ 2M

- operation mode: heating
- power supply: 230 VAC, 50 Hz
- voltage pulse: 4 kV
- energy consumption: < 0.5 W
- output: 2 A (max. 5 A); 230 VAC, 50 Hz
- switching output: NO (max. 10 actuators)
- regulation range: +5°C to +30°C
- frost protection: +5°C
- hysteresis: 0.5 K
- protection: IP30
- sensor type: Bimetal
- type of electrical connection: Spring-loaded contacts
- type of conductors: 0.75 – 1.5 mm² (flexible-stranded core); 1.0 – 2.5 mm² (solid core)
- in compliance with Directive DIN EN 60730

ТЕРМОСТАТ ЗА ОТОПЛЕНИЕ/ОХЛАЖДАНЕ 3(1,5) A 230 V~ 2M

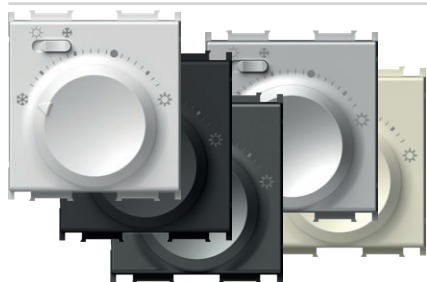

- EM39PW
- EM39MW
- EM39SB
- EM39AT
- EM39ES
- EM39IW

- режим на работа: отопление/охлаждане
- захранване: 230 VAC, 50 Hz
- импулс на напрежение: 4 kV
- консумация на енергия: < 0,5 W
- изход: 1,5 A (макс. 3 A); 230 VAC, 50 Hz
- изходен порт: ключ за превключване (макс. 5 актуатора)
- зона на регулация: +5° C до +30° C
- защита против замръзване: +5° C
- хистерезис: 0,5 K
- защита: IP30
- вид на сензора: Bimetal
- вид на електрическия изход: пружинни клеми
- вид на проводниците: 0,75 – 1,5 кв. мм (с гъвкава жица); 1,0 – 2,5 кв. мм (с твърда жица)
- в съответствие с Директива DIN EN 60730



HEATING/COOLING THERMOSTAT 3(1.5)A 230V~ 2M

- operation mode: cooling/heating
- power supply: 230 VAC, 50 Hz
- voltage pulse: 4 kV
- energy consumption: < 0.5 W
- output: 1 A (max. 3 A); 230 VAC, 50 Hz
- switching output: mode selector switch (max. 5 actuators)
- regulation range: +5°C to +30°C
- frost protection: +5°C
- hysteresis: 0.5 K
- protection: IP30
- sensor type: Bimetal
- type of electrical connection: Spring-loaded contacts
- type of conductors: 0.75 - 1.5mm² (flexible-stranded core); 1.0 - 2.5 mm² (solid core)
- in compliance with the Directive DIN EN 60730

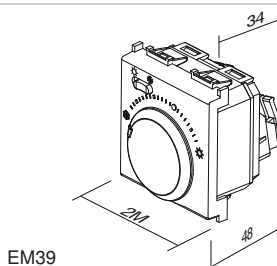
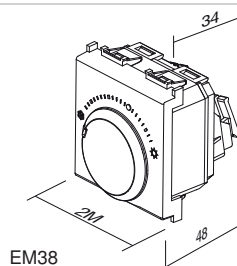
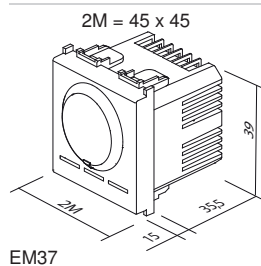
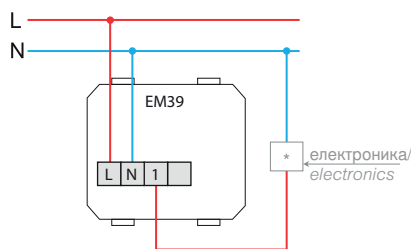
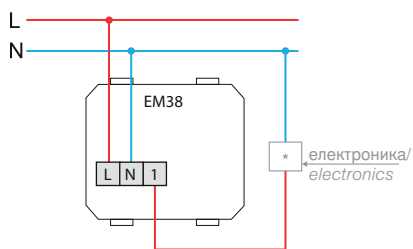

EM37

EM38

EM39

МОНТАЖНА РАМКА С ВИНТОВЕ ЗА ТЕРМОСТАТИ FANTINI COSMI 3M



NM39

- монтажна рамка с винтове за термостати Fantini Cosmi 3M
- подходяща за използване с моделите еднокдневни термостати Fantini Cosmi CH121 и CH123
- подходяща за използване с моделите едноседмични термостати Fantini Cosmi CH141A и CH143A
- за монтаж в правоъгълни конзоли 3M
- подходящо за сглобяване с панели PURE, Line, Soft



MOUNTING FRAME WITH SCREWS FOR FANTINI COSMI THERMOSTATS 3M

- mounting frame with screws for Fantini Cosmi thermostats 3M
- suitable for use with Fantini Cosmi daily thermostats models CH121 and CH123
- suitable for use with Fantini Cosmi weekly thermostats models CH141A and CH143A
- for mounting in rectangular boxes 3M
- suitable for assembling with cover plates PURE, Line, Soft

КЛЮЧ С КАРТА ЗА ИКОНОМИЯ НА ЕНЕРГИЯ ЗА 250V ~ 3M



- EM40PW
- EM40MW
- EM40SB
- EM40AT
- EM40ES
- EM40IW

- ключ с карта, базов, всякаква ISO карта
- захранващо напрежение 230 V~ 50 Hz
- изход 3 A 250 V~ за комутационния контактор *
- закъснение при изключване 15-20 сек
- в съответствие с EN 61000-6-1
- картата не е включена в доставката
- не е предназначено за контрол на достъпа



ENERGY SAVER CARD SWITCH 3A 250V~ 3M

- card switch basic, any ISO card
- supply voltage 230V~ 50Hz
- output 3A 250V~ for switching contactor *
- switch off delay 15-20s
- in accordance with EN 61000-6-1
- card is not included
- not for access control

3M = 67,5 x 45

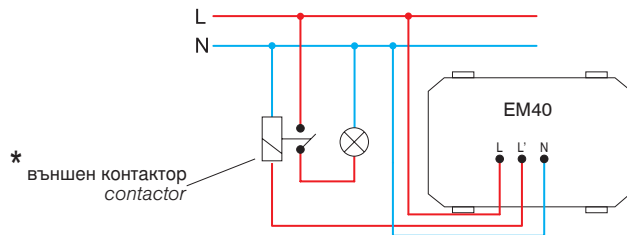
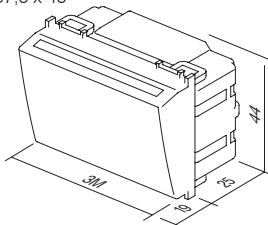

КАРТА ISO

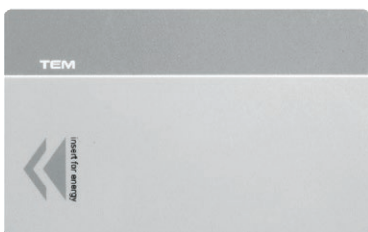

EM47

- карта ISO
- за комбинация с ключ с карта EM40
- размер: 85x54 mm

CARD ISO

- ISO card
- for combination with card switch EM40
- size: 85x54 mm



EM44BK

КЛЮЧ С КАРТА ЗА ИКОНОМИЯ НА ЕНЕРГИЯ RF HF 13,56 MHz 3M

- електронен ключ с карта за RFID ISO карта
- захранва се от релейно устройство EM49 по кабел конектори тип RJ12
- изходът трябва да се свързва с изхода на релейно устройство EM49
- закъснение при изключване на „главното захранване“ 15-20 сек. при изваждане на картата
- закъснение 1 мин. при изключване на „HVAC“ (Отопление, вентилация и климатизация) при изваждане на картата, когато се отворят врати на балкон или прозорец
- в съответствие с EN 61000-6-1
- картата не е включена в доставката
- не е предназначено за контрол на достъпа

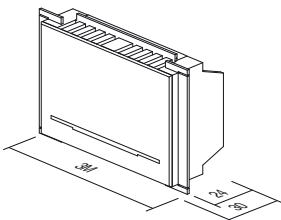

ENERGY SAVER CARD SWITCH RF HF 13,56MHz 3M

- electronic card switch for RFID ISO card
- supply from relay unit EM49 through cable connectors RJ12
- output to be connected to relay output unit EM49
- 15-20s "main power" switch off delay with card withdrawal
- 1 min "HVAC" switch off delay with card withdrawal when balcony doors or windows opened
- in accordance with EN 61000-6-1
- card is not included
- not for access control

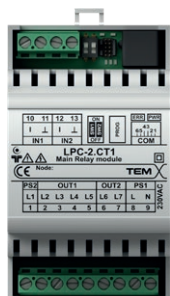

EM49

УСТРОЙСТВО ЗА УПРАВЛЕНИЕ ЗА ИКОНОМИЯ НА ЕНЕРГИЯ 2x16 A 250 V ~

- релейно устройство за ключове с карта EM44
- захранващо напрежение 230 V ~ 50 Hz
- в съответствие с EN 61000-6-1
- за монтаж върху DIN релса 35 mm, 3 MU
- входът и изходът зависят от реализацията: единична или двойна стая

ENERGY SAVER CONTROL UNIT 2x16A 250V~

- relay unit for card switches EM44
- supply voltage 230V ~ 50Hz
- in accordance with EN 61000-6-1
- mounting on DIN rail 35mm, 3MU
- input and output depending on implementation: single or double room

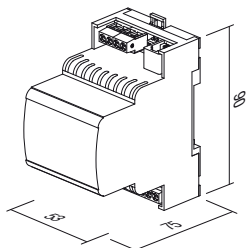

EM45

РАЗПРЕДЕЛИТЕЛ SPL-1

- служи за свързване на два периферни модула EM44 към релейно устройство EM49
- комуникационен конектор тип RJ12
- размер: 37 x 30 x 27 mm

SPLITTER SPL-1

- used to connect two peripheral modules EM44 to relay unit EM49
- communication connector RJ12
- size: 37 x 30 x 27 mm

схема на свързване при реализация за единична стая / wiring diagram for single room implementation

схема на свързване при реализация за двойна стая / wiring diagram for double room implementation

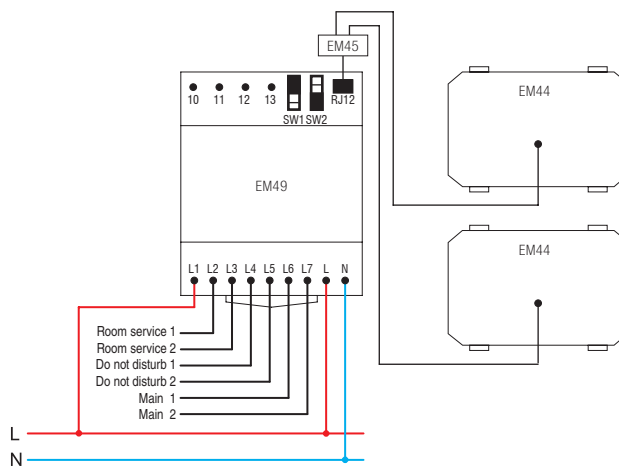
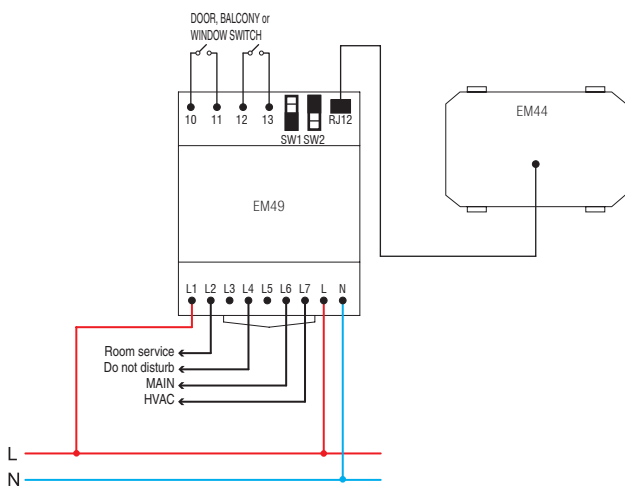

съединителен кабел RJ12 между EM44 и EM49 / connection cable RJ12 between EM44 and EM49

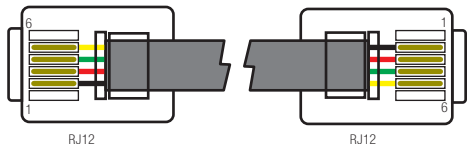

КОНТАКТ ЗА САМОБРЪСНАЧКА 230 V~/120 V~ 3M



- EM60PW
- EM60MW
- EM60SB
- EM60AT
- EM60ES
- EM60IW

- захранващо устройство с разделителен трансформатор 20 VA
- захранване: 230 V~ 50-60 Hz
- изход:
- 230 V~ за 2P 2,5 A Europlug или
- 120 V~ за 2P 15 A Американски щепсел
- клас II
- в съответствие с EN 61558-2-5



SOCKET SHAVER 230V~/120V~ 3M

- shaver supply unit with isolating transformer 20VA
- supply: 230V~ 50-60Hz
- output:
- 230V~ for 2P 2.5A Europlug or
- 120V~ for 2P 15A American plug
- Class II
- in accordance with EN 61558-2-5

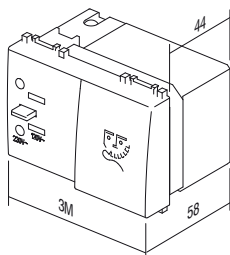

3M = 67,5 x 45

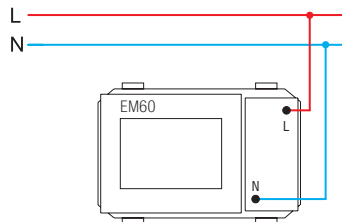

USB ЗАХРАНВАЩО УСТРОЙСТВО 5 V 2,1 A 1M



- EM67PW
- EM67MW
- EM67SB
- EM67AT
- EM67ES
- EM67IW

- за зареждане на електронни устройства от стандартен USB порт (съвместим и с устройства от Apple)
- захранване: 100-230 V~ 50/60 Hz
- консумация: 300 mA при 100 V~/150 mA при 230 V~
- консумация в режим на готовност: 30mW при 230 V~
- номинално изходно напрежение: 5 VDC (±5 %) SELV (безопасно ниско напрежение)
- напрежение на пулсациите на изхода: 150 mV
- номинален изходен ток: 2.1 A (1 x 2,100 mA) (±10 %)
- КПД: максимално 77 %
- работна температура: 0° C/+45° C (само за използване на закрито)
- клас на IP защита: IP20, само за използване на закрито
- устройство клас II
- категория за превишаване на напрежение (EN 62109): клас III
- винтови контакти: макс. 2,5 mm²
- устройство с разстояние между контактите най-малко 3 mm
- в съответствие с EN 60950-1 и директивите за устройства за ниско напрежение и EMC

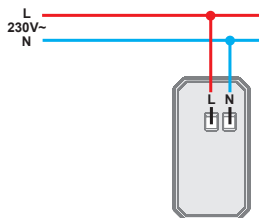
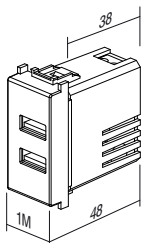

USB POWER SUPPLY UNIT 5V 2,4A 1M

- for charging of electronic devices via a standard USB port (also compatible with Apple devices)
- power supply: 100-230V~ 50/60Hz
- power consumption: 300mA at 100V~/150mA at 230V~
- standby power consumption: 30mW at 230V~
- nominal output voltage: 5 VCD (± 5%) SELV
- output ripple voltage: 150mV
- nominal output current: 2,4A (±10%)
- efficiency: maximum of 77%
- operating temperature: 0° C/+45° C (indoor use)
- IP protection class: IP20, indoor use only
- class device II
- overvoltage category (EN 62109): Class III
- screw contacts: max. 2.5 mm²
- device with a contact gap of at least 3mm
- in accordance with EN 60950-1 and LVD & EMC directives
- not suitable for installation in 45 mm deep boxes and surface mount boxes CUBO IP20

USB ЗАХРАНВАЩ БЛОК 5V 3,0A



- EM68PW
- EM68MW
- EM68SB
- EM68AT
- EM68ES
- EM68IW

- за зареждане на електронни устройства чрез стандартен USB порт (съвместим с устройства на Apple)
- захранване: 100-230V~ 50/60Hz
- консумация на енергия: 300mA при 100V~/150mA при 230V~
- консумация на енергия в режим на готовност: 30mW при 230V~
- номинално изходно напрежение: 5 VCD (± 5%) SELV
- изходно напрежение на пулсации: 150 mV
- номинален изходен ток: 3,0 A (±10%)
- вид конектор: USB A/USB C
- ефективност: максимум 77%
- температура на работа: 0°C/+45°C (за употреба в затворени пространства)
- Клас на IP защита: IP20, само за употреба в затворени пространства
- устройство клас II
- категория свръхнапрежение (EN 62109): Клас III
- контакти с винтови клеми: макс. 2,5 mm²
- устройство с контактна междина най-малко 3 mm
- в съответствие с Директива EN 60950-1 и Директива за безопасност на нисковолтови електрически съоръжения (LVD) и Директива относно електромагнитна съвместимост (EMC)

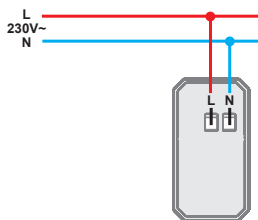
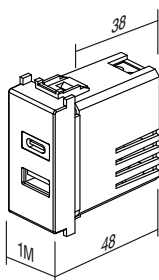

USB POWER SUPPLY UNIT 5V 3,0A

- for charging of electronic devices via a standard USB port (also compatible with Apple devices)
- power supply: 100-230V~ 50/60Hz
- power consumption: 300mA at 100V~/150mA at 230V~
- standby power consumption: 30mW at 230V~
- nominal output voltage: 5 VCD (± 5%) SELV
- output ripple voltage: 150mV
- nominal output current: 3,0 A (±10%)
- connector type: USB A / USB C
- efficiency: maximum of 77%
- operating temperature: 0°C/+45°C (indoor use)
- IP protection class: IP20, indoor use only
- class device II
- overvoltage category (EN 62109): Class III
- screw contacts: max. 2.5 mm²
- device with a contact gap of at least 3mm
- in accordance with EN 60950-1 and LVD & EMC directives
- not suitable for installation in 45 mm deep boxes and surface mount boxes CUBO IP20

СВЕТОДИОДНО АВАРИЙНО ОСВЕТЛЕНИЕ 250 V~ 0,90 W, NiCd 3h 7M



- EM55

- светодиодна лампа за аварийно осветление
- захранващо напрежение 250 V~ 50 Hz 3 x LED 0,3 W, 10000 mcd, 6500 K
- NiCd акумулатор 4,8V 400 mAh, позволяващ смяна автономно действие 3 часа, зареждане 24 часа
- клас II
- в съответствие с EN 60598-1, EN 60598-2-2, EN 60598-2-22



LED EMERGENCY LIGHT 250V~ 0.90W, NiCd 3h 7M

- emergency LED lamp
- supply voltage 250V~ 50Hz 3x LED 0,3W, 10000mcd, 6500K
- NiCd accumulator 4,8V 400 mAh, replaceable
- autonomy 3h, charging 24h
- Class II
- in accordance with EN 60598-1, EN 60598-2-2, EN 60598-2-22

7M = 157 X 45

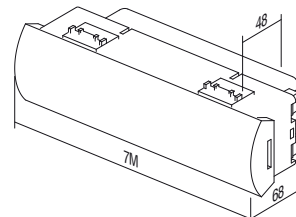
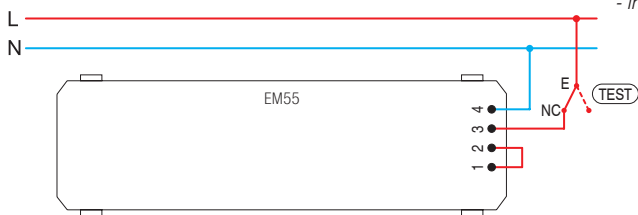

АВАРИЙНА СВЕТОДИОДНА ЛАМПА 230V~50 Hz, 0,5 W, NiMH 2h 2M



- EM57

- аварийна светодиодна лампа
- с опция за употреба и като ръчна лампа (издърпващ се механизъм)
- захранващо напрежение 230 V~50 Hz, 1xLED 0,5 W
- Акумулаторна NiMH батерия 3,6V 140 mAh, сменяема
- автономна работа 2 часа, зареждане 36 часа
- устройство клас II
- в съответствие с EN60598-1, EN60598-2-2, EN62471, EN55015:2006, EN61547

LED EMERGENCY LIGHT 230V~50Hz, 0.5W, NiMH 2h 2M

- emergency LED lamp
- option to use it as a hand lamp (pull-out mechanism)
- supply voltage 230V~50Hz, 1xLED 0.5W
- NiMH accumulator 140mAh, replaceable
- autonomy 2h, charging 36h
- class device II
- in accordance EN60598-1, EN60598-2-2, EN62471, EN55015:2006, EN61547

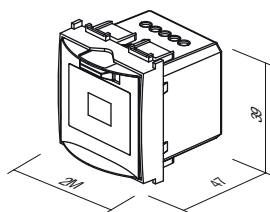
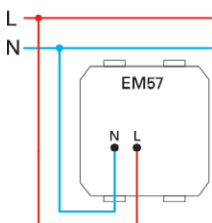
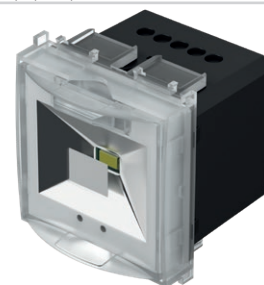

LED АМБИЕНТАЛНА ЧАСТ ЕДНОЦВЕТНА 250 V~ 0,8 W 2M

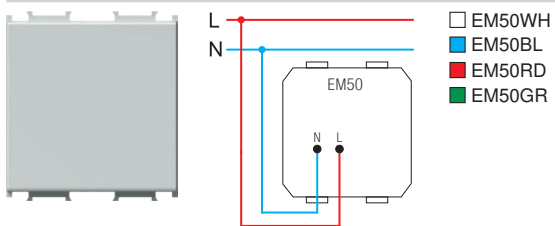

- светодиодна лампа за обозначаване на стъпала
- захранващо напрежение 230 V~ 50 Hz 0,8 W, 6500 K
- клас II
- в съответствие с EN 60598-1
- възможно е да се използва за осветяване на знаци за сигнализация и упътване с отпечатване на текст по желание на клиента с лазерен печат върху дифузора

LED AMBIENT UNIT MONOCOLOUR 250V~ 0,8W 2M

- step marker LED unit
- supply voltage 230V~ 50Hz 0,8W, 6500K
- Class II
- in accordance with EN 60598-1
- optional usage for directional signalization with customized laser printing on diffuser



ДВУЦВЕТНА СВЕТОДИОДНА ЛАМПА 250 V~ 2 x 0,4 W 2M

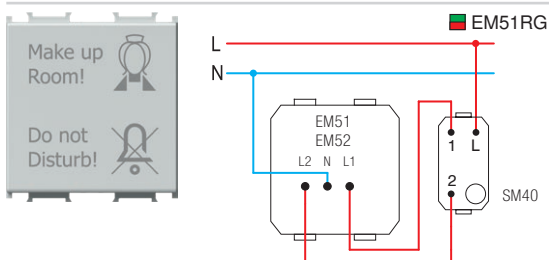

- светодиодна лампа с двоен сигнален цвят (червен/зелен)
- захранващо напрежение 230 V~ 50 Hz 2 x 0,4 W, 6500 K
- клас II
- в съответствие с EN 60598-1
- върху дифузора има графично изображение, както е показано
- възможно е отпечатване по желание на клиента с лазерен печат върху дифузора

LED LAMP DUAL COLOR 250V~ 2x0,4W 2M

- signaling dual color (red/green) LED lamp
- supply voltage 230V~ 50Hz 2x0,4W, 6500K
- Class II
- in accordance with EN 60598-1
- diffuser includes graphics as shown
- possible customized laser printing on diffuser



ДВУЦВЕТНА СВЕТОДИОДНА 3D ЛАМПА 250 V~ 2 x 0,4 W 2M

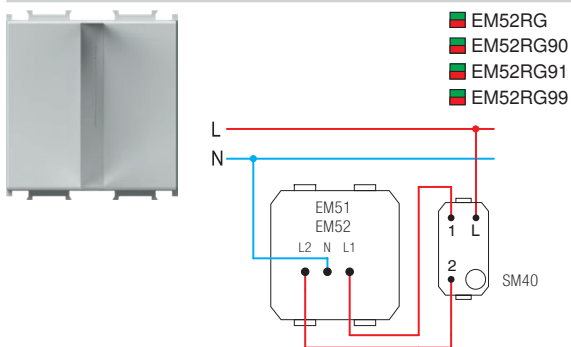

- сигнална светодиодна лампа, два цвята (червен/зелен) с 3D символ
- захранващо напрежение 230 V~ 50 Hz 2 x 0,4 W, 6500 K
- клас II
- в съответствие с EN 60598-1
- възможно е отпечатване на графично изображения по желание на клиента
- 90 символ „Мъже“, 91 символ „Жени“, 99 символ по поръчка

LED LAMP 3D DUAL COLOR 250V~ 2x0,4W 2M

- signalling LED lamp, dual color (red/green) with 3D symbol
- supply voltage 230V~ 50Hz 2x0,4W, 6500K
- class II
- in accordance with EN 60598-1
- possible customized graphics on request
- 90 male symbol, 91 female symbol, 99 symbol on request

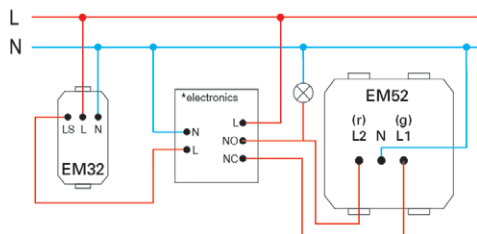
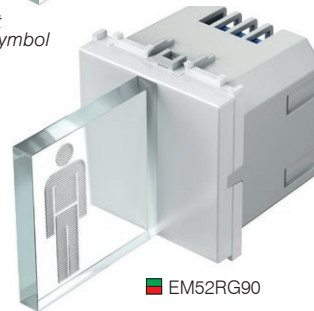
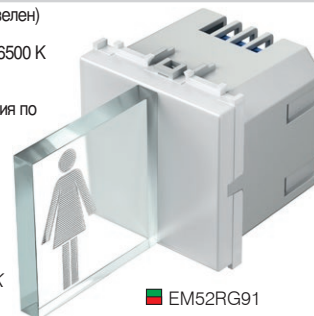

2M = 45 x 45

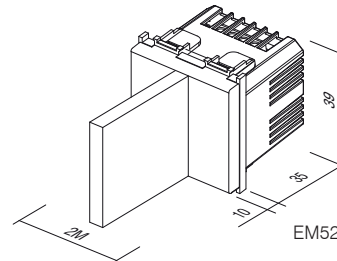
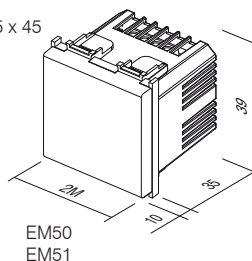



- EM71PW
- EM71MW
- EM71SB
- EM71AT
- EM71ES
- EM71IW

ПРЕВКЛЮЧВАТЕЛ С ПРЪСТОВ ОТПЕЧАТЪК BIOPASS 2M

- Превключвател с пръстов отпечатък с включен вътрешен релейен модул и захранване
- Капацитет: 500 пръстови отпечатъка
- Лесно управление чрез мобилното приложение X-Manager
- Захранващо напрежение: 8 – 30 V – DC или AC (с включено захранване)
- Капацитивен сензор
- 2 изходни релета
- Максимално напрежение/ток в релето: 40 V/3 A
- Време за задействане на релето: 1 – 10 сек
- Максимална мощност: 3,6 W
- 256-битова шифрована връзка между превключвателя и вътрешния релейен модул
- Комплект с включени NM24 монтажна рамка и OS20 декоративна рамка.

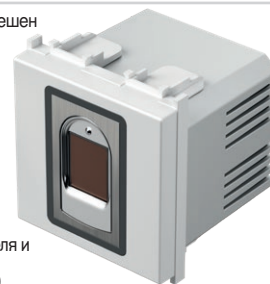

FINGERPRINT SWITCH BIOPASS 2M

- fingerprint switch with included internal relay unit and power supply
- capacity: 500 fingerprints
- easy management via X-Manager mobile app
- power supply voltage: 8-30V – DC or AC (power supply included)
- capacitive sensor
- 2 output relays
- maximum voltage/current on relay: 40V/3A
- relay triggering time: 1-10 sec
- maximum power: 3.6W
- 256-bit encrypted link between switch and internal relay unit
- Set also includes NM24 mounting frame and OS20 decorative cover plate.

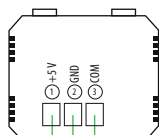
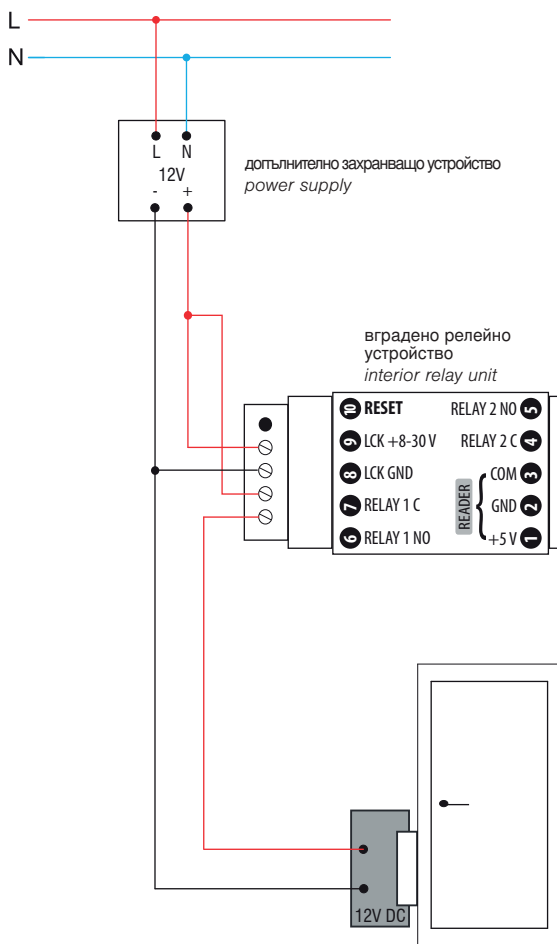

външно устройство exterior unit

X-Manager app



support.tem.si



електрическа ключалка electric lock

външно устройство exterior unit

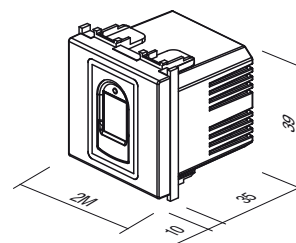

МУЛТИФУНКЦИОНАЛЕН ВРЕМЕВИ КЛЮЧ



- EM82PW
- EM82MW
- EM82SB
- EM82AT
- EM82ES
- EM82IW

- Захранващо напрежение: 230 VAC, 50 Hz
- Изход: Реле 16 A/250 VAC, 50 Hz
- Сечение на проводниците: 0,75 – 4,0 mm²
- Работна температура: 0 до +40 °C
- Температура при съхранение: -5 до +60 °C
- Функции: таймер, реле (управляващ контакт), Ключ, ключ със сензорно задействане
- Индикация на програмата/състоянието: RGB LED
- Брой на бутоните: 2
- Тип функциониране на бутона: Капацитивно
- Брой на портовете: 6 – 2x N, 2x L, 1x изход (L'), 1x управляващ вход (S)
- Възможност за управляващ вход Да. Включване на сигнала за мрежово напрежение (230 VAC) към съединителен елемент S.
- Приложено функциониране »нулевата стойност« (превключване на контакта при преминаване на напрежението през 0 V)
- Ключ EM82 НЕ Е ПОДХОДЯЩ за вграждане в конзола под мазилка на дълбочина 45 mm и в монтажна рамка CUBO IP20.
- Ключът е предназначен за използването във вътрешни помещения, защитени от въздействието на влага.

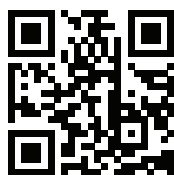
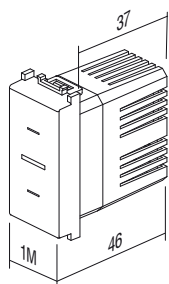

MULTIPURPOSE TIMER SWITCH EM82

- Supply voltage: 230 VAC, 50Hz
- Output: *Relé* 16 A / 250 V AC, 50Hz
- Wire cross section: 0,75 – 4.0 mm²
- Operating temperature: 0 to + 40 °C
- Storage temperature: -5 to + 60 °C
- Functions: **Timer, Relay (controlled switch), Switch, Push button**
- Program/status indication: RGB LED
- Number of buttons: 2
- Push button operation type: Capacitive
- Number of ports: 6 - 2x N, 2x L, 1x Output (L'), 1x Controlled input (S)
- Controlled input option: Yes. Connection of the main voltage signal (230 VAC) to terminal S.
- Implemented "zero crossing" operation (switching the switch when the voltage passes through 0 V)
- Power consumption in the OFF / ON state: 0.3 W / 1.0 W
- The EM82 switch is NOT SUITABLE for installation in concealed boxes with a depth of 45 mm and CUBO IP20 housing.
- The switch is intended for indoor use, protected from moisture.



- 1 - Бутон 1
- 2 - LED ИНДИКАТОР
- 3 - Бутон 2

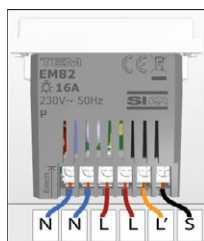

- N НЕУТРАЛЕН ПРОВОДНИК
- L ФАЗОВ ПРОВОДНИК
- L' ИЗХОД (УПРАВЛЯВАНА ФАЗА)
- S ВХОДЕН УПРАВЛЯВАН СИГНАЛ (230 VAC)

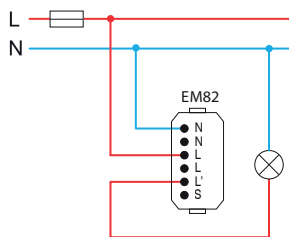

EM82 IS IN A SWITCH OR A TIMER MODE

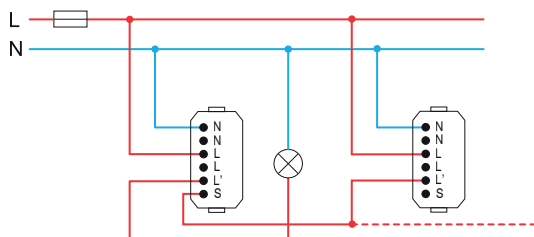

EM82-1 IS IN A SWITCH OR A TIMER MODE
EM82-2 IS IN A PUSH BUTTON MODE

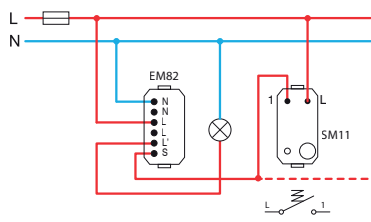

EM82 IS IN A SWITCH OR A TIMER MODE

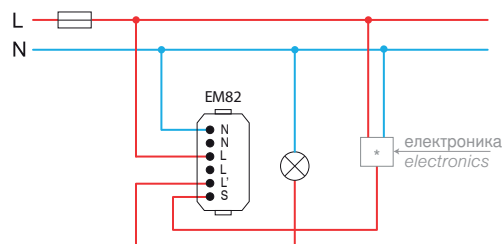

EM82 IS IN A RELAY MODE

	1	2	3	4	5	6	7	8
Max.	16 A	16 A	16 A	8 A	8 A5	A	200 VA	200 VA

1 - incandescent lamp
2 - halogen lamp

3 - resistive heating element
4 - electronic transformer

5 - classical transformer
6 - motor

7 - energy saving CFL lamp
8 - LED lamp

OPERATION OF THE CONTROL SIGNAL S – MODE 1

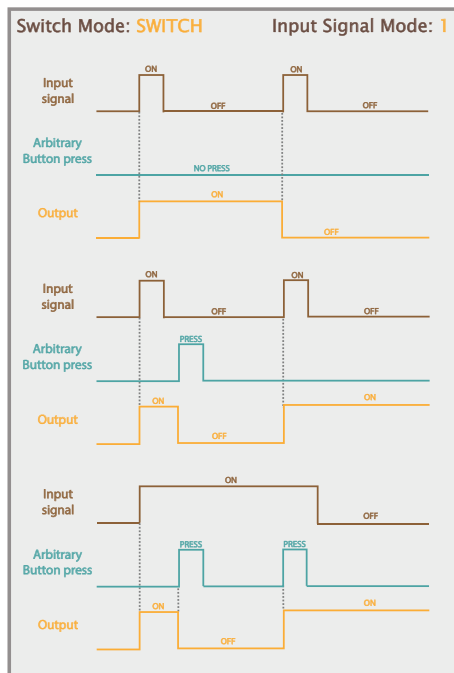

FIGURE 6: DISPLAY OF THE OPERATION OF THE EXTERNAL SIGNAL S AND BUTTONS IN THE SWITCH OPERATING MODE AND EXTERNAL SIGNAL IN MODE 1

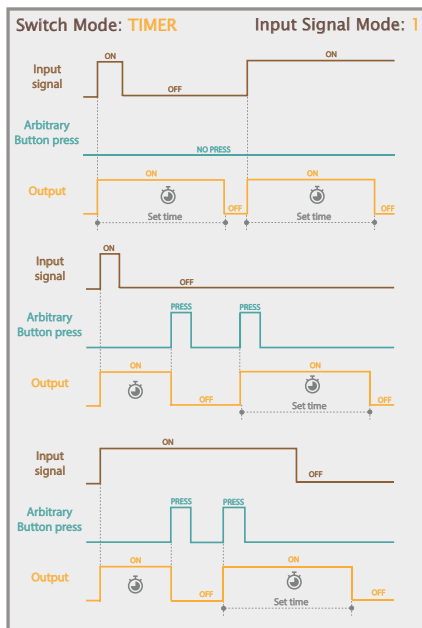

FIGURE 7: DISPLAY OF THE OPERATION OF THE EXTERNAL SIGNAL S AND BUTTONS IN THE TIMER OPERATING MODE AND EXTERNAL SIGNAL IN MODE 1

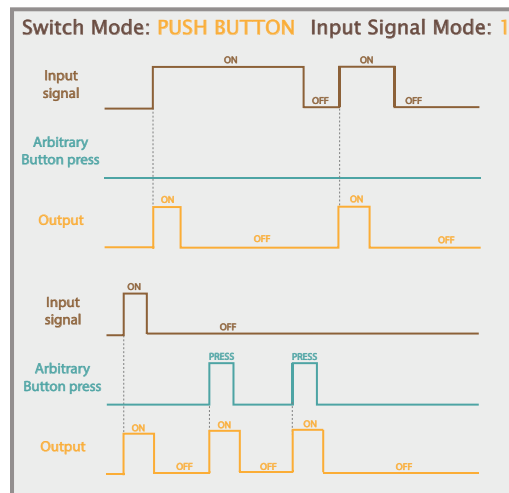

FIGURE 8: DISPLAY OF THE OPERATION OF THE EXTERNAL SIGNAL S AND BUTTONS IN THE PUSH BUTTON OPERATING MODE AND EXTERNAL SIGNAL IN MODE 1

OPERATION OF THE CONTROL SIGNAL S – MODE 2

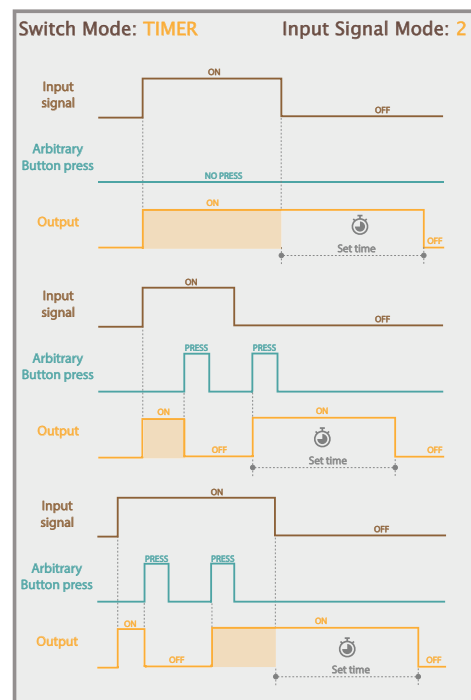

FIGURE 10: DISPLAY OF THE OPERATION OF THE EXTERNAL SIGNAL S AND BUTTONS IN THE TIMER OPERATING MODE AND EXTERNAL SIGNAL IN MODE 2

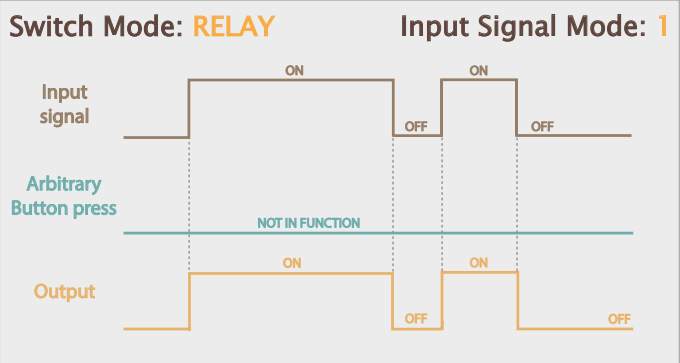

FIGURE 9: DISPLAY OF THE OPERATION OF THE EXTERNAL SIGNAL S AND BUTTONS IN THE RELAY OPERATING MODE AND EXTERNAL SIGNAL IN MODE 1

OPERATING MODE SETTINGS OF THE EXTERNAL CONTROL SIGNAL S

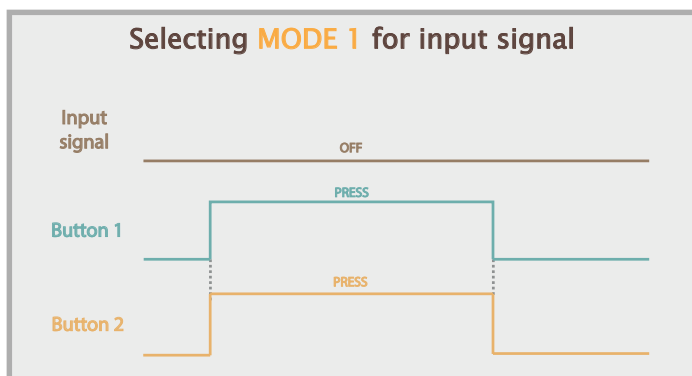

FIGURE 11: SETTING THE OPERATING MODE OF THE INPUT SIGNAL S FOR MODE 1

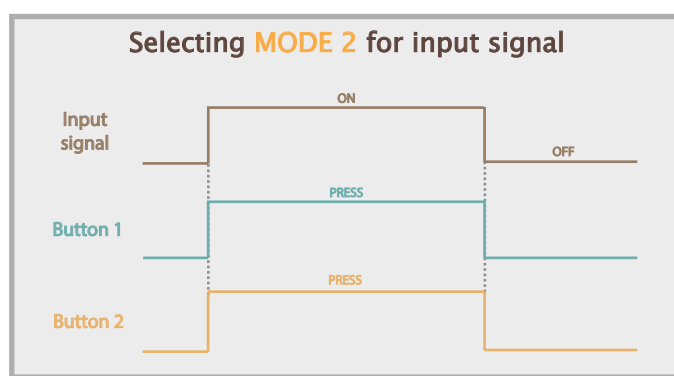

FIGURE 12: SETTING THE OPERATING MODE OF THE INPUT SIGNAL S FOR MODE 2

БЕЗКОНТАКТЕН КЛЮЧ, 10 А 240 V~



■ EM80GW

- безконтактен ключ за включване/изключване („главен“)
- захранване: 240 V~ 50 Hz
- релеен изход 10 A/250 V~ (2400 W при 240 V~)
- регулируем диапазон 2 до 10 cm
- предназначен е за инсталиране в стандартна кръгла конзола Ø60 mm
- за свързването се изисква проводник за неутралата (N)
- не е възможно свързване с двупосочен ключ
- възможно е свързване с до 5 ключа за управление EM81
- лесно инсталиране на декоративни капаци с помощта на магнити
- винтово захващане на проводници със сечение до 2,5 mm² (макс. въртящ момент за притягане 0,4 Nm)
- в съответствие с EN 60669-1 и EN 60669-2-1
- само за използване на закрито



SWITCH, TOUCHLESS 10A 240V~

- touchless switch for turning on/off ("master")
- power supply: 240 V~ 50 Hz
- output relay 10A / 250V~ (2400W at 240V~)
- adjustable range from 2 to 10 cm
- intended for installation into a standard round Ø60 mm box
- a neutral lead (N) is required for connection
- connection with toggle switches is not possible
- connection with up to 5 EM81 control switches is possible
- simple installation of decorative covers with the help of magnets
- screw fastening of leads up to 2,5 mm² (max. screw tightening torque is 0.4 Nm)
- in accordance with EN 60669-1 and EN 60669-2-1
- only for indoor use

БЕЗКОНТАКТЕН КЛЮЧ, УСТРОЙСТВО ЗА УПРАВЛЕНИЕ



■ EM81GW

- ключ за управление („подчинен“)
- функционира само при свързване с ключ EM80 („главен“)
- регулируем диапазон 2 до 10 cm
- лесно инсталиране на декоративни капаци с помощта на магнити
- винтово захващане на проводници със сечение до 2,5 mm² (макс. въртящ момент за притягане е 0,4 Nm)
- в съответствие с EN 60669-1 и EN 60669-2-1
- само за използване на закрито



SWITCH, TOUCHLESS, CONTROL UNIT

- control switch ("slave")
- works only when connected with the EM80 switch ("master")
- adjustable range from 2 to 10 cm
- simple installation of decorative covers with the help of magnets
- screw fastening of leads up to 2.5 mm² (max. screw tightening torque is 0.4 Nm)
- in accordance with EN 60669-1 and EN 60669-2-1
- only for indoor use

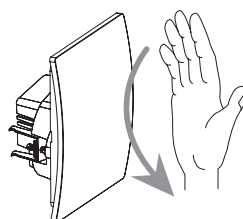
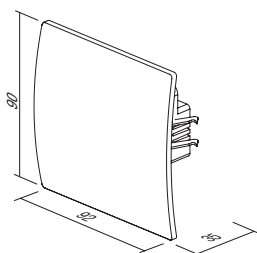
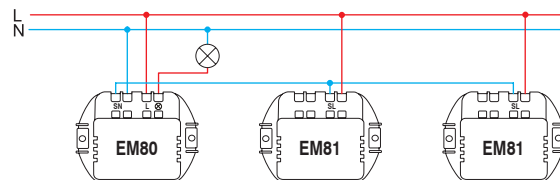
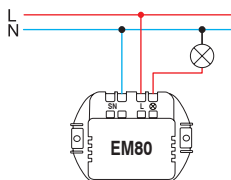

ЗУМЕР 8 VA 230 V~1M

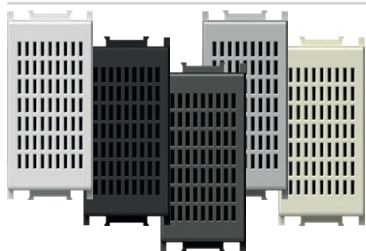

- EM90PW
- EM90MW
- EM90SB
- EM90AT
- EM90ES
- EM90IW

- сигнален зумер
 - издаването на звук продължава колкото управляващото действие
 - захранващо напрежение 230 V ~ 50 Hz 8 VA
BUZZER 8VA 230V~1M
 - signal buzzer
 - the sound emission has the same lasting time as the control operation
 - supply voltage 230V~ 50Hz 8VA

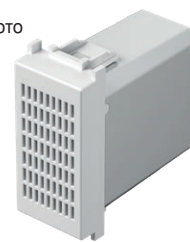

ЗУМЕР 8 VA 230 V~1M

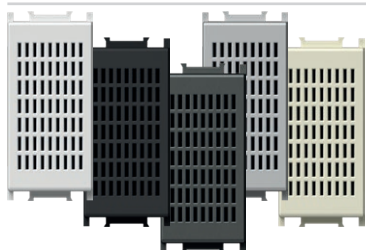

- EM91PW
- EM91MW
- EM91SB
- EM91AT
- EM91ES
- EM91IW

- сигнален зумер
 - издаването на звук продължава колкото управляващото действие
 - захранващо напрежение 230 V ~ 50 Hz 8 VA
BUZZER 8VA 12V~1M
 - signal buzzer
 - the sound emission has the same lasting time as the control operation
 - supply voltage 12V~ 50Hz 8VA

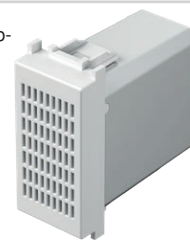

ЗВЪНЕЦ 8 VA 230 V~1M

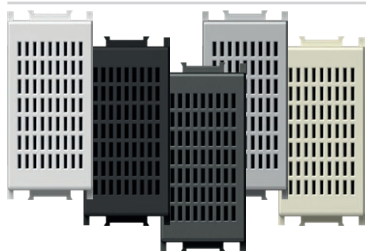

- EM92PW
- EM92MW
- EM92SB
- EM92AT
- EM92ES
- EM92IW

- сигнален звънец
 - издаването на звук продължава колкото управляващото действие
 - захранващо напрежение 230 V ~ 50 Hz 8 VA
BELL 8VA 230V~1M
 - signal bell
 - the sound emission has the same lasting time as the control operation
 - supply voltage 230V~ 50Hz 8VA

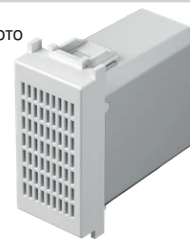

ЗВЪНЕЦ 8 VA 12V~1M

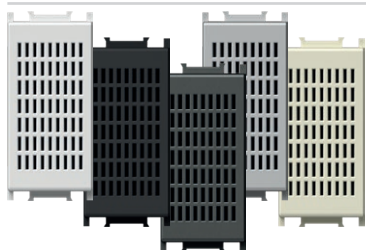

- EM93PW
- EM93MW
- EM93SB
- EM93AT
- EM93ES
- EM93IW

- сигнален звънец
 - издаването на звук продължава колкото управляващото действие
 - захранващо напрежение 12 V~ 50 Hz 8 VA
BELL 8VA 12V~1M
 - signal bell
 - the sound emission has the same lasting time as the control operation
 - supply voltage 12V~ 50Hz 8VA

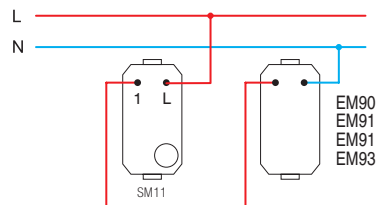
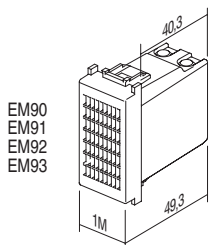

ЕЛЕКТРОНЕН ЗВЪНЕЦ 230V~ 6mA rms 1M

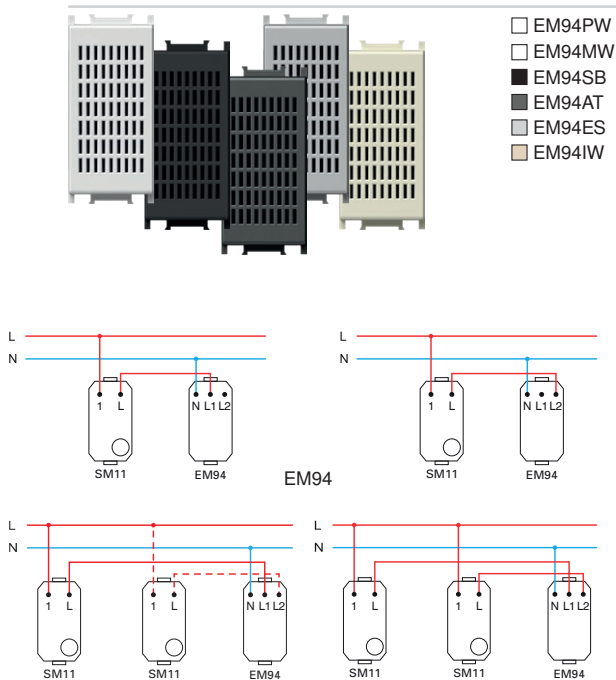

- захранване: 230 V~ 50/60 Хц
- консумация за мелодия 1: 4, 7 mA rms
- консумация за мелодия 2: 5, 9 mA rms
- ниво на звука на мелодия 1: 2, 86 Дб
- ниво на звука на мелодия 2: 86 Дб
- температура при функциониране: 0 C/45 C (при вътрешно използване)
- температура при съхранение: -20 C/ 50 C
- IP защитен клас: IP20 (само за вътрешно използване)
- клас на безопасност на устройството: II
- защита от прекалено напрежение (EN62109): клас III
- прикрепване на водещите елементи с болтове: макс 2, 5 кв. мм
- устройство с оттегляне на контактите: мин 3 мм
- Леснодостъпен прекъсвач ключ може да бъде монтиран нагоре по веригата на звънеца
- В съответствие с Директивата за безопасност на нисковолтови електрически съоръжения (LVD) и Директивата относно електромагнитната съвместимост (EMC)



ELECTRONIC BELL 230V~ 6mA rms 1M

- power supply 230 V~ 50/60 Hz
- power consumption when playing melody 1: 4.7 mA rms
- power consumption when playing melody 2: 5.9 mA rms
- sound level of melody 1: 90.5 dB
- sound level of melody 2: 86 dB
- operating temperature 0°C/45°C (indoor use)
- storage temperature: -20°C/50°C
- IP protection class: IP20 (indoor use only)
- class device II
- overvoltage category (EN62109): Class III
- screw contacts: max. 2.5 mm²
- device with a contact gap of at least 3 mm
- an easily accessible cut-off switch must be installed upstream from bell
- complies with EMC & LVD directives

РЕГУЛАТОР НА СИЛАТА НА ЗВУКА 100 V AUDIO LINE 35 W 2M

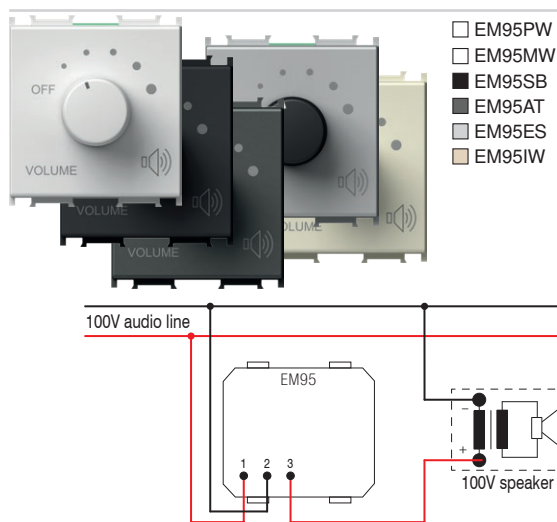

- регулатор на силата на звука (атенуатор) за аудиосистеми 100 V
- номинална мощност 35 W (макс. 45 W), 6 нива регулиране на силата на звука
- подходящо за инсталиране в конзоли (с мин. дълбочина 60 mm)
- не е подходящо за инсталиране в конзоли с дълбочина 45 mm и конзоли за външен монтаж CUBO IP20
- само за използване на закрито



VOLUME CONTROL 100V AUDIO LINE 35W 2M

- volume control (attenuator) for 100V audio systems
- power rating 35W (max.45W), 6 steps volume control
- suitable for boxes min. 60 mm deep
- not suitable for installation in 45 mm deep boxes and surface mount boxes CUBO IP20
- for indoor use only

РЕГУЛАТОР НА СИЛАТА НА ЗВУКА 4-8 Ω 35 W 2M

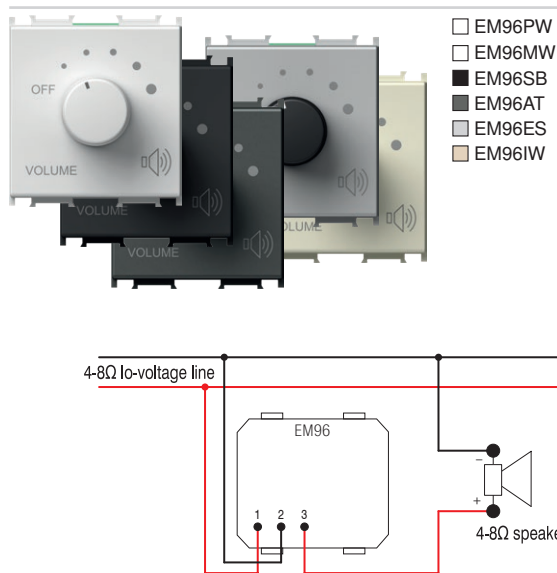

- регулатор на силата на звука (атенуатор) за изходи с ниско напрежение 4-8 Ω, 35 W
- допуска се свързване на HI-FI устройства
- номинална мощност 35 W, 6 нива на регулиране на силата на звука
- подходящо за инсталиране в конзоли (с мин. дълбочина 60 mm)
- не е подходящо за инсталиране в конзоли с дълбочина 45 mm и конзоли за външен монтаж CUBO IP20
- само за използване на закрито



VOLUME CONTROL 4-8 Ω 35W 2M

- volume control (attenuator) for low voltage outputs 4-8 Ω, 35W
- power rating 35W, 6 steps volume control
- suitable for boxes min. 60 mm deep
- not suitable for installation in 45 mm deep boxes and surface mount boxes CUBO IP20
- for indoor use only

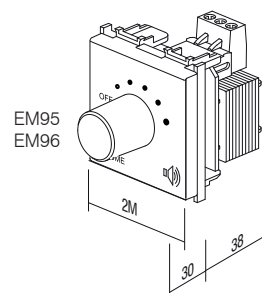



CM25

PW

OS

тип type	описание description	технически данни technical data	размер size	цвет colour	допълнителна информация 1 optional data 1
CM10	КОМПЛЕКТ КОНТАКТИ 2xШУКО SOCKET SET 2x SCHUKO	2P+E 16A 250V~	4M	<input type="checkbox"/> PW снежнобял цвят polar white	<input type="checkbox"/> OL панел LINE cover plate LINE
CM11	КОМПЛЕКТ КОНТАКТИ 3xШУКО SOCKET SET 3x SCHUKO	2P+E 16A 250V~	7M	<input type="checkbox"/> MW Бял матов цвят matte white	<input type="checkbox"/> OS панел SOFT cover plate SOFT
CM15	КОМПЛЕКТ СЪЕДИНИТЕЛНИ ПРОВОДНИЦИ LINK WIRE SET	3x1.5mm ²	1M	<input checked="" type="checkbox"/> SB сензорен бутон, черен soft touch black	
·	·	·	·	<input checked="" type="checkbox"/> AT антрацит anthracite	
·	·	·	·	<input type="checkbox"/> ES сребрист elox silver	
·	·	·	·	<input type="checkbox"/> IW слонова кост ivory white	

КОМПЛЕКТ КОНТАКТИ 2 x ШУКО 2P+E 16 A 250 V~ 4M

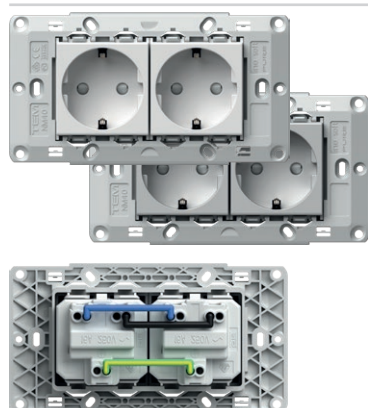

- CM10PW
 CM10ES

- комплект контакти 2 x шуко VM10 2P+E 16 A 250 V~
- предварително свързани съединителни проводници CM16
- с монтажна рамка 4M без винтове
- за закрепване към монтажна рамка използвайте винтове CM17, CM18 или CM19
- винтови контакти 1,5 - 2,5 mm²
- в съответствие с IEC 60884-1, CEE7

SOCKETS SET 2x SCHUKO 2P+E 16A 250V~ 4M

- socket set 2x schuko VM10 2P+E 16A 250V~
- prewired with link wires CM16
- with mounting frame 4M without screws
- for mounting frame fixing use screws CM17, CM18 or CM19
- screw contacts 1.5-2.5 mm²
- in accordance with IEC-60884-1, CEE7

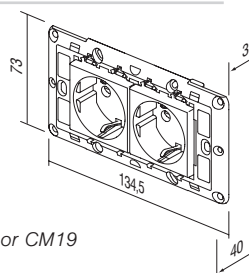

КОМПЛЕКТ КОНТАКТИ 3 x ШУКО 2P+E 16 A 250 V~ 7M

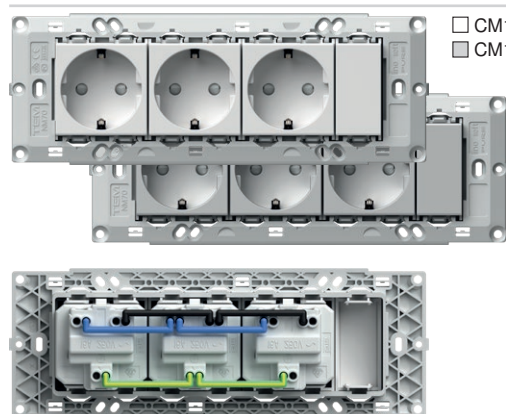

- CM11PW
 CM11ES

- комплект контакти 3 x шуко VM10 2P+E 16 A 250 V~
- предварително свързани съединителни проводници CM16
- с монтажна рамка 7M без винтове
- за закрепване към монтажна рамка използвайте винтове CM17, CM18 или CM19
- винтови контакти 1,5 - 2,5 mm²
- в съответствие с IEC 60884-1, CEE7

SOCKETS SET 3x SCHUKO 2P+E 16A 250V~ 7M

- socket set 3x schuko VM10 2P+E 16A 250V~
- prewired with link wires CM16
- with mounting frame 7M without screws
- for mounting frame fixing use screws CM17, CM18 or CM19
- screw contacts 1.5-2.5 mm²
- in accordance with IEC-60884-1, CEE7

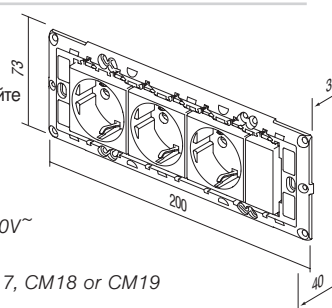

КОМПЛЕКТ СЪЕДИНИТЕЛНИ ПРОВОДНИЦИ 3 x 1,5 mm², 1M

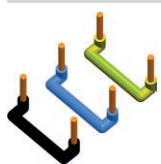

CM15

- комплект съединителни проводници за свързване на два елемента с размер 1M
- съдържа 10 черни, 10 сини и 10 жълти/зелени проводника

LINK WIRE SET 3x1.5mm² 1M

- link wire set to connect two elements size 1M
- includes 10 black, 10 blue and 10 yellow/green wires

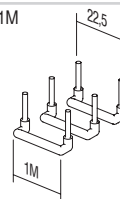

КОМПЛЕКТ СЪЕДИНИТЕЛНИ ПРОВОДНИЦИ 3 x 2,5 mm², 2M

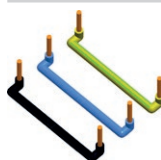

CM16

- комплект съединителни проводници за свързване на два елемента с размер 2M
- съдържа 10 черни, 10 сини и 10 жълти/зелени проводника

LINK WIRE SET 3x2.5mm² 2M

- link wire set to connect two elements size 2M
- includes 10 black, 10 blue and 10 yellow/green wires

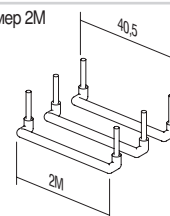

КОМПЛЕКТ ВИНТОВЕ 3,5

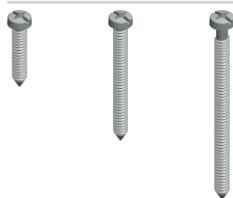

CM17

CM18

CM19

- адаптер за закрепване за монтажни рамки NM30, NM32, NM40, NM41, NM70
- CM17 - l=20 mm, 100 бр.
- CM18 - l=35 mm, 50 бр.
- CM19 - l=50mm, 50 бр.

SCREW SET 3,5

- screw set for fixing mounting frames NM30, NM32, NM40, NM41, NM70
- CM17 - l=20mm, 100pcs
- CM18 - l=35mm, 50pcs
- CM19 - l=50mm, 50pcs

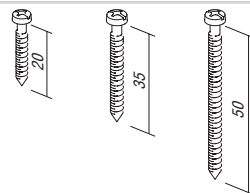

КОМПЛЕКТ КЛЮЧОВЕ IP44 2M



CM22PW

CM22MW

CM22SB

CM22AT

CM22ES

CM22IW

- за използване във влажни зони
- предоставена защита IP44 за всички ключове Modul
- ключовете и бутоните не са част от комплекта
- панел SOFT 2M с надпис
- в съответствие с IEC 60669-1

SET SWITCHES IP44 2M

- for usage in humid areas
- IP44 protection provides for all Modul switches
- switches and buttons are not part of the set
- SOFT 2M cover plate with inscription plate
- in accordance with IEC 60669-1



КОМПЛЕКТ КОНТАКТИ IP44 2M



CM23PW

CM23MW

CM23SB

CM23AT

CM23ES

CM23IW

- за използване във влажни зони
- защита IP44 може да се постигне само в комбинация с покрит контакт (VM11, VM41)
- контактите не са част от комплекта
- панел SOFT 2M с надпис
- в съответствие с IEC 60884-1

SET SOCKETS IP44 2M

- for usage in humid areas
- IP44 protection can be achieved only in combination with covered socket (VM11, VM41)
- sockets are not part of the set
- SOFT 2M cover plate with inscription plate
- in accordance with IEC 60884-1



КОМПЛЕКТ КЛЮЧОВЕ ЗА БАНЯ 3 x 20 A 250 V~ 4M

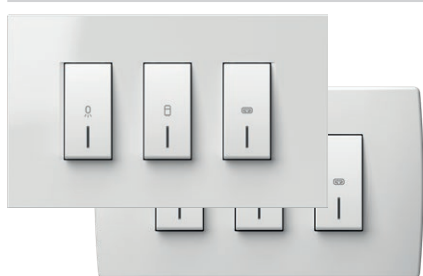

CM25PWOL

CM25IWOL

CM25PWOS

CM25IWOS

- комплект ключове 3 x SM12 20 A 250 V~ с монтажна рамка и панел
- винтови контакти 1,5 - 2,5 mm²
- в съответствие с EN 60669-1
- универсално решение за подновяване на конзоли с размери за закрепване 108-135 mm или конзоли размер 4M
- височина на панела 90 mm

SWITCH SET FOR BATHROOM 3x20A 250V~ 4M

- switch set 3xSM12 20A 250V~ with mounting frame and cover plate
- screw contacts 1.5-2.5mm²
- in accordance with EN 60669-1
- universal solution for renovation on boxes with fixing dimensions 108-135mm or boxes 4M size
- cover plate height 90mm

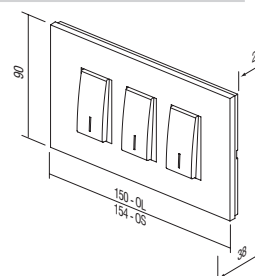

МОНТАЖНА РАМКА ЗА КОМПЛЕКТ ЗА БАНЯ 4М



NM41

- универсална монтажна рамка за комплект за баня с винтове
- универсално решение за монтиране върху правоъгълни конзоли с размери за закрепване 108-135 mm или конзоли размер 4M
- в съответствие с EN 60669-1

MOUNTING FRAME BATHROOM SET 4M

- universal mounting frame for bathroom set with screws
- universal solution for mounting on rectangular boxes with fixing dimensions 108-135mm or boxes 4M size
- in accordance with EN 60669-1

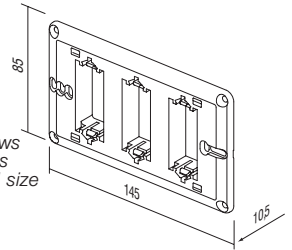

ПАНЕЛ LINE ЗА КОМПЛЕКТ ЗА БАНЯ



- | | |
|--|--------|
| | OL41PW |
| | OL41MW |
| | OL41NB |
| | OL41IW |
| | OL41ES |
| | OL41SG |
| | OL41IB |
| | OL41AT |
| | OL41TI |
| | OL41SB |

- декоративен панел LINE за комплект за баня
- височина 90 mm
- в съответствие с EN 60669-1

COVER PLATE LINE BATHROOM SET

- decorative cover plate bathroom set LINE
- height 90mm
- in accordance with EN 60669-1

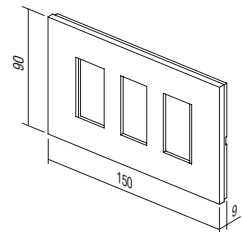

ПАНЕЛ SOFT ЗА КОМПЛЕКТ ЗА БАНЯ

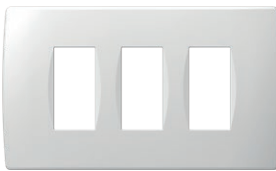

- | | | | |
|--|--------|--|--------|
| | OS41PW | | OS41SB |
| | OS41MW | | OS41WE |
| | OS41NB | | OS41AT |
| | OS41IW | | OS41TI |
| | OS41ES | | |
| | OS41SG | | |

- декоративен панел SOFT за комплект за баня
- височина 90 mm
- в съответствие с EN 60669-1

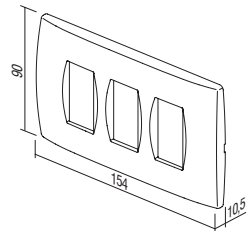

COVER PLATE SOFT BATHROOM SET

- decorative cover plate bathroom set SOFT
- height 90mm
- in accordance with EN 60669-1



МОДУЛ ЗА АНТИБАКТЕРИАЛНА ПРОГРАМА

The diagram illustrates the antibacterial program module. It shows a hand being washed with water. Labels TM11, AW, and IN are placed above the hand, indicating the location of the module components. Below the diagram is a table with columns for type, description, size, color, and optional data 1.

тип type	описание description	размер size	цвет colour	допълнителна информация 1 optional data 1
TM11	БУТОН BUTTON	1M	<input type="checkbox"/> AW антибактериален, бял antibacterial white	 NT неутрален neutral
TM21	КАПАЧЕ BLANK	1M		
VM10	КОНТАКТ SOCKET	2M		 IN индикатор indicator
.	.	.		
.	.	.		
.	.	.		

МОДУЛ ЗА АНТИБАКТЕРИАЛНА ПРОГРАМА

- ключовете и контактите всеки ден се докосват от много хора, поради което са общо място за развитие и разпространение на бактерии
- благодарение на естествените си антибактериални свойства, среброто вече три хилядолетия се използва като безопасен и ефикасен дезинфектант, тъй като е напълно естествено, здравословно и не уврежда околната среда
- добавката със специални антибактериални йони осигурява дълготрайно надеждна и ефикасна защита против развитието и разпространението на бактерии, микроби и плесени
- антибактериалната защита осигурява поддържане хигиена, чистота и здраве
- антибактериалната програма MODUL е изключително подходяща за приложение в среда със строги изисквания за хигиена (болници, здравни центрове, фармацевтични обекти, домове за възрастни, приюти, лаборатории, ресторанти, хотели, летища, автобусни и железопътни станции, бизнес и търговски зони, обществени институции...)
- проведени са независими лабораторни изпитвания в съответствие с най-високите японски стандарти JIS Z 2801
- ниски разходи за подобряване на човешкото здраве
- структурата и функционалността на антибактериалната програма MODUL позволяват лесно почистване и поддръжка
- антибактериалните бутони, панели и контакти се комбинират с класически монтажни рамки и ключове
- продуктите са обозначени отзад с AW (антибактериален, бял)

ANTIBACTERIAL PROGRAM MODUL

- switches and sockets are daily touched by many people, so this is a common place for development and spread of bacteria
- thanks to its natural antibacterial characteristics silver has been used for three millennia as a safe and effective disinfectant, since it is completely natural, healthy and environmentally friendly
- special antibacterial silver ions additive provides long-term, reliable and effective protection against the development and spread of bacteria, microbes and fungi
- antibacterial protection ensures hygiene, cleanliness and health for people
- perfectly suitable for use in environments with strict hygiene conditions (hospitals, health centers, pharmaceutical facilities, homes for elderly, nursing homes, laboratories, restaurants, hotels, airports, bus and railway stations, business and shopping areas, public institutions ...)
- independent laboratory testings have been carried out in accordance with highest Japanese standards JIS Z 2801
- low cost for providing human health
- design and functionality of antibacterial program MODUL allow easy cleaning and maintenance
- antibacterial buttons, cover plates and sockets are combined with classic mounting frames and switches
- products are labelled on the back with AW (antibacterial white)

ANTIBACTERIAL PROGRAM MODUL

БУТОН 1М



TM11AW

- сменяем бутон 1М, в съответствие с EN 60669-1
- антибактериална защита в съответствие с изискванията по стандарт JIS Z 2801

BUTTON 1M

- replaceable button 1M
- in accordance with EN 60669-1
- antibacterial protection in accordance with JIS Z 2801



БУТОН 1М С ИНДИКАТОР



TM11AWIN

- сменяем бутон 1М, в съответствие с EN 60669-1
- антибактериална защита в съответствие с изискванията по стандарта JIS Z 2801

BUTTON 1M INDICATOR

- replaceable button 1M
- in accordance with EN 60669-1
- antibacterial protection in accordance with JIS Z 2801



БУТОН 2М



TM12AW

- сменяем бутон 2М с носач за бутон
- за надграждане на ключ или бутон от размер 1М към размер 2М
- в съответствие с EN 60669-1
- антибактериална защита в съответствие с изискванията по стандарт JIS Z 2801

BUTTON 2M

- replaceable button 2M with button carrier
- to upgrade switch or push button from size 1M to size 2M
- in accordance with EN 60669-1
- antibacterial protection in accordance with JIS Z 2801



БУТОН 2М С ИНДИКАТОР



TM12AWIN

- сменяем бутон 2М с носач за бутон
- за надграждане на ключ или бутон от размер 1М към размер 2М
- в съответствие с EN 60669-1
- антибактериална защита в съответствие с изискванията по стандарт JIS Z 2801

BUTTON 2M INDICATOR

- replaceable button 2M with button carrier
- to upgrade switch or push button from size 1M to size 2M
- in accordance with EN 60669-1
- antibacterial protection in accordance with JIS Z 2801



КАПАЧЕ 1М



TM21AW

- модулно капаче за покриване на неизползвани позиции
- в съответствие с EN 60669-1
- антибактериална защита в съответствие с изискванията по стандарт JIS Z 2801

BLANK 1M

- blank modul to fill up empty spaces
- in accordance with EN 60669-1
- antibacterial protection in accordance with JIS Z 2801



КАПАЧЕ 2М



TM22AW

- модулно капаче за покриване на неизползвани позиции
- в съответствие с EN 60669-1
- антибактериална защита в съответствие с изискванията по стандарт JIS Z 2801

BLANK 2M

- blank modul to fill up empty spaces
- in accordance with EN 60669-1
- antibacterial protection in accordance with JIS Z 2801

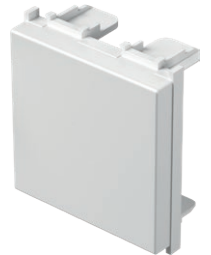



□ VM10AW

КОНТАКТ SCHUKO+KS 2P+E 16A 250V~ 2M

- 2P+E шуко, 16A 250V~, тип VM10
- в съответствие с IEC 60884-1, CEE7
- винтови контакти 1,5 - 2,5 mm²
- вградена защита от докосване на контактите
- антибактериална защита в съответствие с изискванията по стандарт JIS Z 2801

SOCKET SCHUKO+KS 2P+E 16A 250V~ 2M

- 2P+E schuko
- 16A 250V~, type VM10
- in accordance with IEC 60884-1, CEE7
- screw contacts 1.5-2.5 mm²
- built-in contact protection
- antibacterial protection in accordance with JIS Z 2801



□ VM11AW

КОНТАКТ SCHUKO+KS+COVER 2P+E 16A 250V~ 2M

- 2P+E шуко+капак, 16A 250V~, тип VM11
- в съответствие с IEC 60884-1, CEE7
- винтови контакти 1,5 - 2,5 mm²
- вградена защита от докосване на контактите
- антибактериална защита в съответствие с изискванията по стандарт JIS Z 2801

SOCKET SCHUKO+KS+COVER

- 2P+E 16A 250V~ 2M
- 2P+E schuko+cover
- 16A 250V~, type VM11
- in accordance with IEC 60884-1, CEE7
- screw contacts 1.5-2.5 mm²
- built-in contact protection
- antibacterial protection in accordance with JIS Z 2801



□ VM20AW

КОНТАКТ EURO+KS 2P 10 A 250 V~ 1M

- 2P Euro, 10 A 250 V~, тип VM20
- в съответствие с IEC 60884-1, CEE7
- винтови контакти 1,5 - 2,5 mm²
- вградена защита от докосване на контактите
- антибактериална защита в съответствие с изискванията по стандарт JIS Z 2801

SOCKET EURO+KS 2P 10A 250V~ 1M

- 2P Euro
- 10A 250V~, type VM20
- in accordance with IEC 60884-1, CEE7
- screw contacts 1.5-2.5 mm²
- built-in contact protection
- antibacterial protection in accordance with JIS Z 2801



□ KM11AW

КОНЕКТОР ЗА ТВ КРАЕН 1 dB 1M

- контакт за ТВ краен
- честотен обхват 5÷2400 MHz, затихване < 1 dB
- в съответствие с EN 50083-1
- винтови контакти
- антибактериална защита в съответствие с изискванията по стандарт JIS Z 2801

SOCKET TV END-LINE 1dB 1M

- TV end-line
- frequency range 5÷2400 MHz
- reduction < 1 dB
- in accordance with EN 50083-1
- screw contacts
- antibacterial protection in accordance with JIS Z 2801

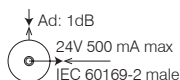

□ KM35AW

АДАПТЕР KS 1M

- KS модул стандарт за закрепване
- AMP, Avaya, Brandrex, FMT, Mfico, Tyco, ...
- комуникационният модул не е включен в доставката
- антибактериална защита в съответствие с изискванията по стандарт JIS Z 2801

ADAPTER KS 1M

- KS keystone fixing standard
- AMP, Avaya, Brandrex, FMT, Mfico, Tyco, ...
- communication module not included
- antibacterial protection in accordance with JIS Z 2801

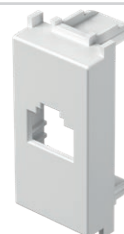

A N T I B A C T E R I A L P R O G R A M M O D U L



OS20AW

ПАНЕЛ SOFT 2M

- декоративен панел SOFT 2M
- в съответствие с EN 60669-1
- антибактериална защита в съответствие с изискванията по стандарт JIS Z 2801

COVER PLATE SOFT 2M

- decorative cover plate SOFT 2M
- in accordance with EN 60669-1
- antibacterial protection in accordance with JIS Z 2801



OS24AW

ПАНЕЛ SOFT 2x2M

- декоративен панел SOFT 2x2M
- хоризонтален или вертикален монтаж
- в съответствие с EN 60669-1
- антибактериална защита в съответствие с изискванията по стандарт JIS Z 2801

COVER PLATE SOFT 2x2M

- decorative cover plate SOFT 2x2M
- horizontal or vertical mounting
- in accordance with EN 60669-1
- antibacterial protection in accordance with JIS Z 2801



OS26AW

ПАНЕЛ SOFT 3x2M

- декоративен панел SOFT 3x2M
- хоризонтален или вертикален монтаж
- в съответствие с EN 60669-1
- антибактериална защита в съответствие с изискванията по стандарт JIS Z 2801

COVER PLATE SOFT 3x2M

- decorative cover plate SOFT 3x2M
- horizontal or vertical mounting
- in accordance with EN 60669-1
- antibacterial protection in accordance with JIS Z 2801



OS30AW

ПАНЕЛ SOFT 3M

- декоративен панел SOFT 3M
- в съответствие с EN 60669-1
- антибактериална защита в съответствие с изискванията по стандарт JIS Z 2801

COVER PLATE SOFT 3M

- decorative cover plate SOFT 3M
- in accordance with EN 60669-1
- antibacterial protection in accordance with JIS Z 2801



OS40AW

ПАНЕЛ SOFT 4M

- декоративен панел SOFT 4M
- в съответствие с EN 60669-1
- антибактериална защита в съответствие с изискванията по стандарт JIS Z 2801

COVER PLATE SOFT 4M

- decorative cover plate SOFT 4M
- in accordance with EN 60669-1
- antibacterial protection in accordance with JIS Z 2801

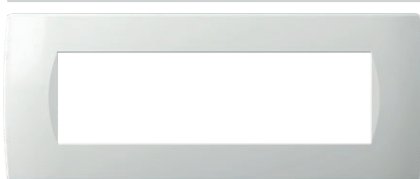

OS70AW

ПАНЕЛ SOFT 7M

- декоративен панел SOFT 7M
- в съответствие с EN 60669-1
- антибактериална защита в съответствие с изискванията по стандарт JIS Z 2801

COVER PLATE SOFT 7M

- decorative cover plate SOFT 7M
- in accordance with EN 60669-1
- antibacterial protection in accordance with JIS Z 2801

Дърво
wood

WB бамбук
bamboo



WW орех
walnut



WM клен
maple



WE венге
wenge



Природата е уникална и прецизна, и сред нашите декоративни панели няма два еднакви.
Рекламации във връзка с разнообразния външен вид на дървени декоративни панели и различия не се приемат.

Nature is unique and precious, as our decorative cover plates where no two are the same.
Complaints about wooden decorative cover plate's diverse appearance and differentiation cannot be considered.

COVER PLATES PURE OP

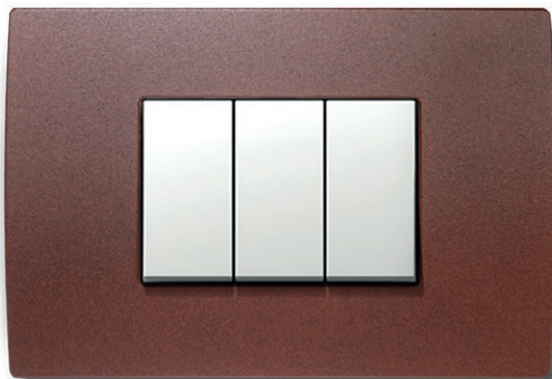
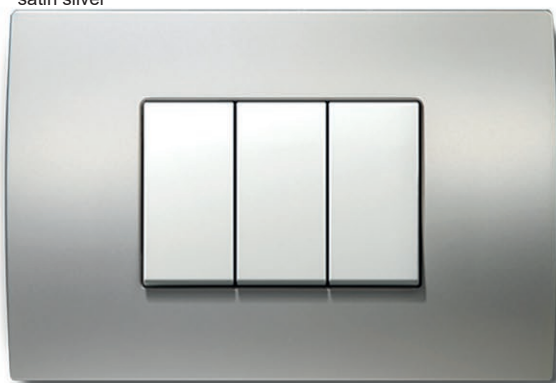
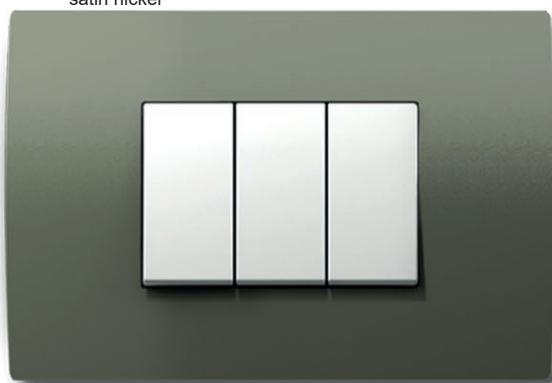
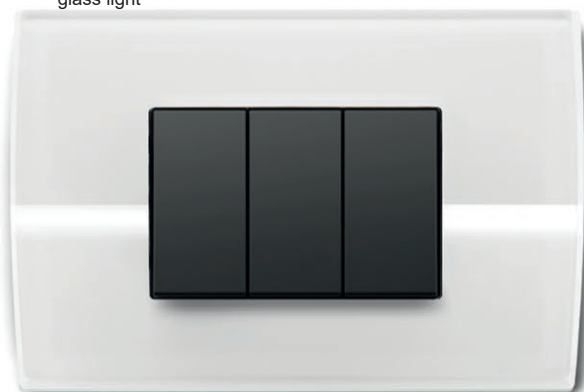
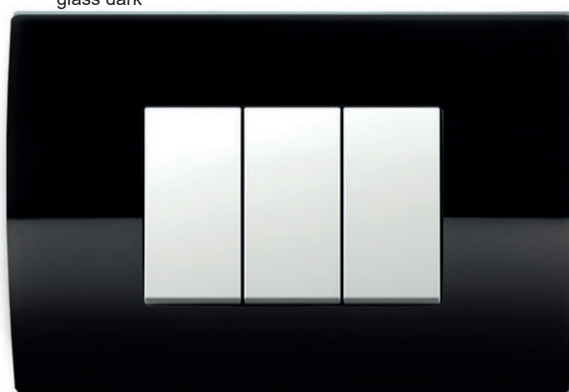
МЕТАЛ
metalMH ковано желязо
hammered steelME ецвано желязо
etched ironMS матов сребрист цвят
satin silverMN матов никел
satin nickel**СТЪКЛО**
glassGL бяло
glass lightGD черно
glass dark

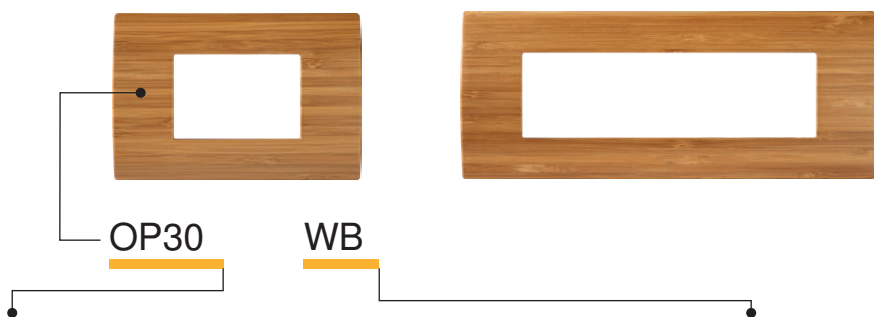

тип type	описание description	размер size	цвет colour
OP13	ПАНЕЛ PURE COVER PLATE PURE	1/3M	MH ковано желязо hammered steel
OP20	ПАНЕЛ PURE COVER PLATE PURE	2M	ME ецвано желязо etched iron
OP23	ПАНЕЛ PURE COVER PLATE PURE	2/3M	MS матов сребрист satin silver
...	MN матов никел satin nickel

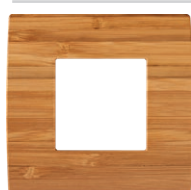

MH	OP20MH	WB	OP20WB
ME	OP20ME	WW	OP20WW
MS	OP20MS	WM	OP20WM
MN	OP20MN	WE	OP20WE
		GL	OP20GL
		GD	OP20GD

ПАНЕЛ PURE 2M

- декоративен панел PURE 2M
- в съответствие с EN 60669-1
- само в комбинация с монтажна рамка NM24 или NM25

COVER PLATE PURE 2M

- decorative cover plate PURE 2M
- in accordance with EN 60669-1
- only in combination with mounting frame NM24 or NM25

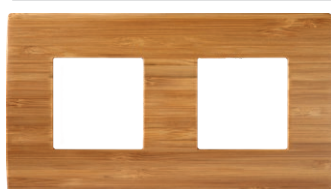

MH	OP24MH	WB	OP24WB
ME	OP24ME	WW	OP24WW
MS	OP24MS	WM	OP24WM
MN	OP24MN	WE	OP24WE
		GL	OP24GL
		GD	OP24GD

ПАНЕЛ PURE 2x2M

- декоративен панел PURE 2x2M
- хоризонтален или вертикален монтаж
- в съответствие с EN 60669-1
- само в комбинация с монтажна рамка NM24 или NM25

COVER PLATE PURE 2x2M

- decorative cover plate PURE 2x2M
- horizontal or vertical mounting
- in accordance with EN 60669-1
- only in combination with mounting frames NM24 or NM25



MH	OP26MH	WB	OP26WB
ME	OP26ME	WW	OP26WW
MS	OP26MS	WM	OP26WM
MN	OP26MN	WE	OP26WE
		GL	OP26GL
		GD	OP26GD

ПАНЕЛ PURE 3x2M

- декоративен панел PURE 3x2M
- хоризонтален или вертикален монтаж
- в съответствие с EN 60669-1
- само в комбинация с монтажна рамка NM24 или NM25

COVER PLATE PURE 3x2M

- decorative cover plate PURE 3x2M
- horizontal or vertical mounting
- in accordance with EN 60669-1
- only in combination with mounting frames NM24 or NM25



MH	OP28MH	WB	OP28WB
ME	OP28ME	WW	OP28WW
MS	OP28MS	WM	OP28WM
MN	OP28MN	WE	OP28WE
		GL	OP28GL
		GD	OP28GD

ПАНЕЛ PURE 4x2M

- декоративен панел PURE 4x2M
- хоризонтален или вертикален монтаж
- в съответствие с EN 60669-1
- само в комбинация с монтажна рамка NM24 или NM25

COVER PLATE PURE 4x2M

- decorative cover plate PURE 4x2M
- horizontal or vertical mounting
- in accordance with EN 60669-1
- only in combination with mounting frames NM24 or NM25

COVER PLATES PURE OP



	OP30MH		OP30WB
	OP30ME		OP30WW
	OP30MS		OP30WM
	OP30MN		OP30WE
			OP30GL
			OP30GD

ПАНЕЛ PURE 3M

- декоративен панел PURE 3M
- в съответствие с EN 60669-1

COVER PLATE PURE 3M

- decorative cover plate PURE 3M
- in accordance with EN 60669-1



	OP40MH		OP40WB
	OP40ME		OP40WW
	OP40MS		OP40WM
	OP40MN		OP40WE
			OP40GL
			OP40GD

ПАНЕЛ PURE 4M

- декоративен панел PURE 4M
- в съответствие с EN 60669-1

COVER PLATE PURE 4M

- decorative cover plate PURE 4M
- in accordance with EN 60669-1



	OP70MH		OP70WB
	OP70ME		OP70WW
	OP70MS		OP70WM
	OP70MN		OP70WE
			OP70GL
			OP70GD

ПАНЕЛ PURE 7M

- декоративен панел PURE 7M
- в съответствие с EN 60669-1

COVER PLATE PURE 7M

- decorative cover plate PURE 7M
- in accordance with EN 60669-1



	OP13MH		OP13WB
	OP13ME		OP13WW
	OP13MS		OP13WM
	OP13MN		OP13WE
			OP13GL
			OP13GD

ПАНЕЛ PURE 1/3M

- декоративен панел PURE 1/3M
- в съответствие с EN 60669-1

COVER PLATE PURE 1/3M

- decorative cover plate PURE 1/3M
- in accordance with EN 60669-1



	OP23MH		OP23WB
	OP23ME		OP23WW
	OP23MS		OP23WM
	OP23MN		OP23WE
			OP23GL
			OP23GD

ПАНЕЛ PURE 2/3M

- декоративен панел PURE 2/3M
- в съответствие с EN 60669-1

COVER PLATE PURE 2/3M

- decorative cover plate PURE 2/3M
- in accordance with EN 60669-1

базов
basic

PW снежнобял цвят
polar white

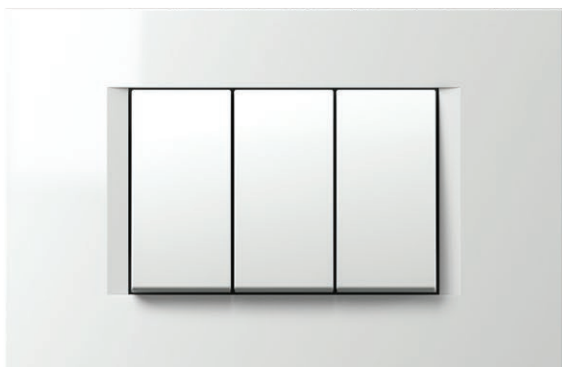

IW слонова кост
ivory white

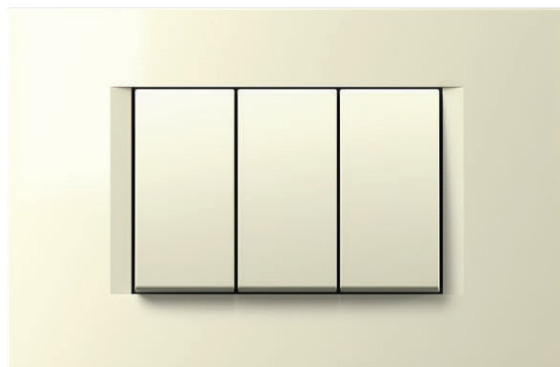

ES сребрист цвят с анодизирано покритие
elox silver



SB сензорен бутон, черен
soft touch black

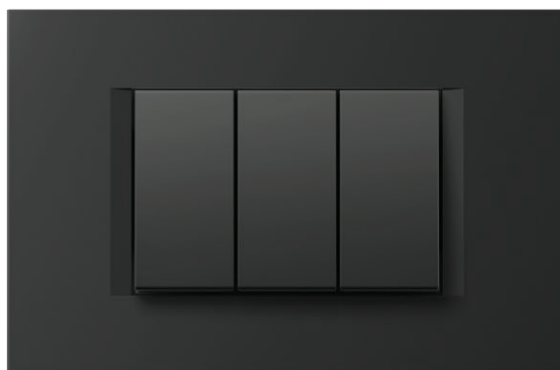

AT антрацит
anthracite

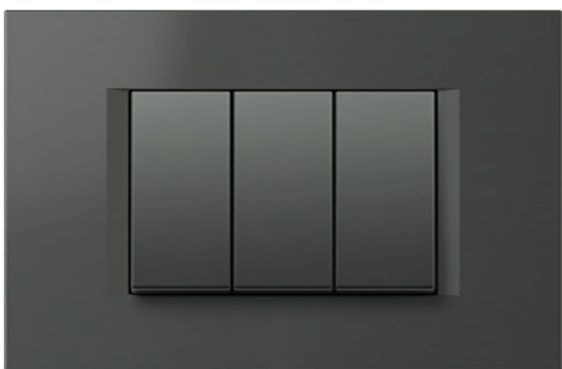

MW Бял матов цвят
matte white

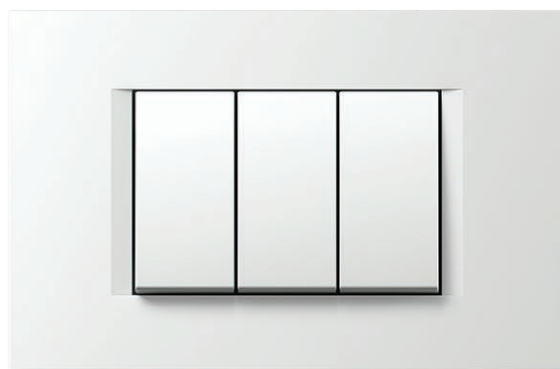

C O V E R P L A T E S L I N E O L

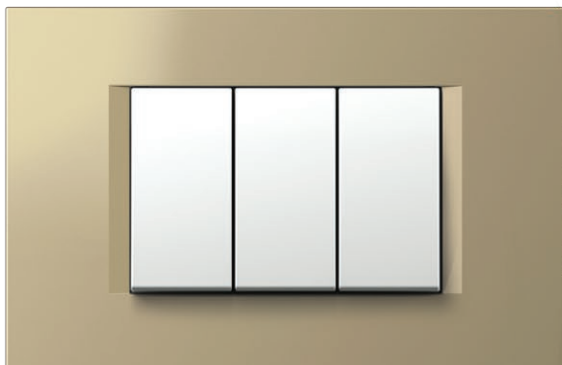
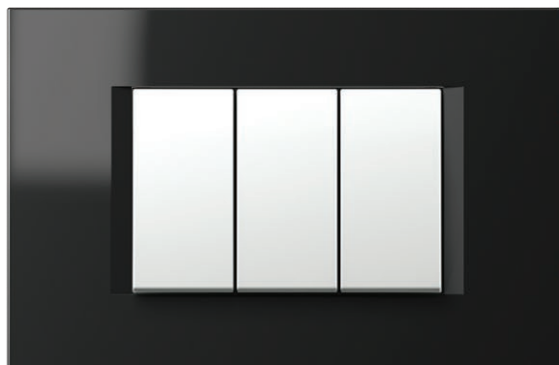
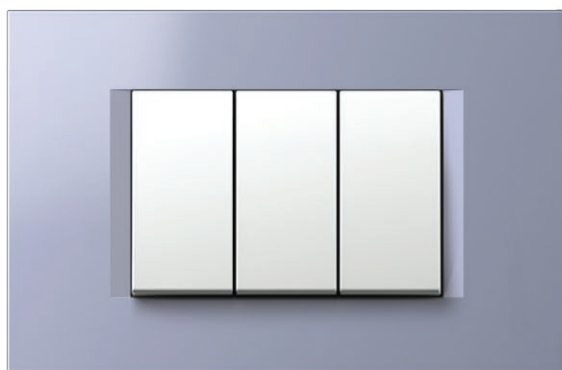
ДЕКОР
decorSG пясъчнозлатист
sand goldNB тъмночерен
night blackIB Импулно синьо
impulse blueTI титан
titaniumSW бял камък
stone white

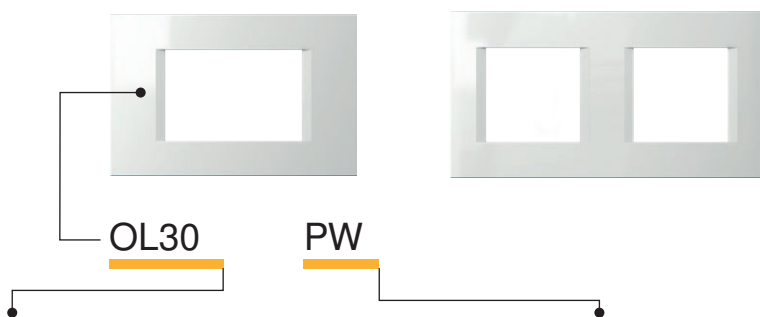

тип type	описание description	размер size	цвет colour															
OL10	ПАНЕЛ LINE COVER PLATE LINE	1/2M	<table border="0"> <tr> <td></td> <td>PW</td> <td>снежнобял цвят polar white</td> </tr> <tr> <td></td> <td>SG</td> <td>пясъчнозлатист sand gold</td> </tr> <tr> <td></td> <td>AT</td> <td>антрацит anthracite</td> </tr> </table>		PW	снежнобял цвят polar white		SG	пясъчнозлатист sand gold		AT	антрацит anthracite						
	PW	снежнобял цвят polar white																
	SG	пясъчнозлатист sand gold																
	AT	антрацит anthracite																
OL13	ПАНЕЛ LINE COVER PLATE LINE	1/3M	<table border="0"> <tr> <td></td> <td>MW</td> <td>Бял матов цвят matte white</td> </tr> <tr> <td></td> <td>NB</td> <td>тъмночерен night black</td> </tr> <tr> <td></td> <td>TI</td> <td>титан titanium</td> </tr> </table>		MW	Бял матов цвят matte white		NB	тъмночерен night black		TI	титан titanium						
	MW	Бял матов цвят matte white																
	NB	тъмночерен night black																
	TI	титан titanium																
OL20	ПАНЕЛ LINE COVER PLATE LINE	2M	<table border="0"> <tr> <td></td> <td>IW</td> <td>слонова кост ivory white</td> </tr> <tr> <td></td> <td>IB</td> <td>Импулсно синьо impulse blue</td> </tr> <tr> <td></td> <td>SW</td> <td>бял камък stone white</td> </tr> <tr> <td></td> <td>ES</td> <td>анодизирано покритие elox silver</td> </tr> <tr> <td></td> <td>SB</td> <td>сензорен бутон, черен soft touch black</td> </tr> </table>		IW	слонова кост ivory white		IB	Импулсно синьо impulse blue		SW	бял камък stone white		ES	анодизирано покритие elox silver		SB	сензорен бутон, черен soft touch black
	IW	слонова кост ivory white																
	IB	Импулсно синьо impulse blue																
	SW	бял камък stone white																
	ES	анодизирано покритие elox silver																
	SB	сензорен бутон, черен soft touch black																



ПАНЕЛ LINE 2M

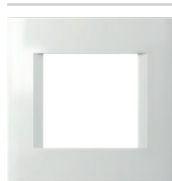

	OL20PW		OL20SG
	OL20MW		OL20NB
	OL20IW		OL20IB
	OL20ES		OL20AT
	OL20SB		OL20TI
			OL20SW

- декоративен панел LINE 2M
- в съответствие с EN 60669-1
COVER PLATE LINE 2M
- decorative cover plate LINE 2M
- in accordance with EN 60669-1

ПАНЕЛ LINE 2x2M

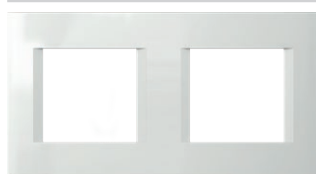

	OL24PW		OL24SG
	OL24MW		OL24NB
	OL24IW		OL24IB
	OL24ES		OL24AT
	OL24SB		OL24TI
			OL24SW

- декоративен панел LINE 2x2M
- хоризонтален или вертикален монтаж
- в съответствие с EN 60669-1
COVER PLATE LINE 2x2M
- decorative cover plate LINE 2x2M
- horizontal or vertical mounting
- in accordance with EN 60669-1

ПАНЕЛ LINE 3x2M

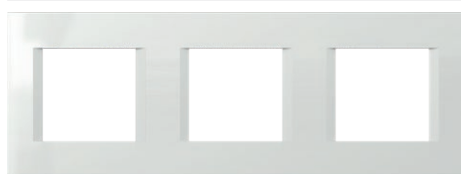

	OL26PW		OL26SG
	OL26MW		OL26NB
	OL26IW		OL26IB
	OL26ES		OL26AT
	OL26SB		OL26TI
			OL26SW

- декоративен панел LINE 3x2M
- хоризонтален или вертикален монтаж
- в съответствие с EN 60669-1
COVER PLATE LINE 3x2M
- decorative cover plate LINE 3x2M
- horizontal or vertical mounting
- in accordance with EN 60669-1

ПАНЕЛ LINE 4x2M



	OL28PW		OL28SG
	OL28MW		OL28NB
	OL28IW		OL28IB
	OL28ES		OL28AT
	OL28SB		OL28TI
			OL28SW

- декоративен панел LINE 4x2M
- хоризонтален или вертикален монтаж
- в съответствие с EN 60669-1
COVER PLATE LINE 4x2M
- decorative cover plate LINE 4x2M
- horizontal or vertical mounting
- in accordance with EN 60669-1

ПАНЕЛ LINE 5x2M

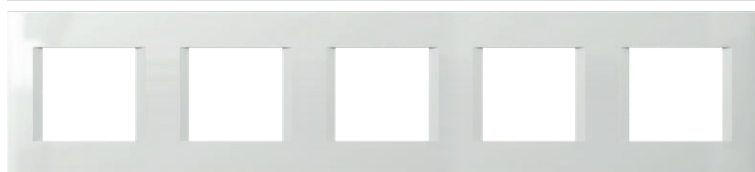







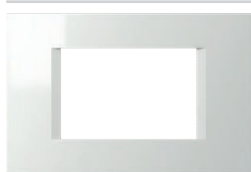



	OL29PW
	OL29MW
	OL29IW
	OL29ES
	OL29SB
	OL29AT
	OL29TI

- декоративен панел LINE 5x2M
- хоризонтален или вертикален монтаж
- в съответствие с EN 60669-1
COVER PLATE LINE 5x2M
- decorative cover plate LINE 5x2M
- horizontal or vertical mounting
- in accordance with EN 60669-1

COVER PLATES LINE OL



 OL30PW	 OL30SG
 OL30MW	 OL30NB
 OL30IW	 OL30IB
 OL30ES	 OL30AT
 OL30SB	 OL30TI
	 OL30SW









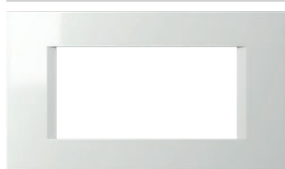

ПАНЕЛ LINE 3M

- декоративен панел LINE 3M
- в съответствие с EN 60669-1

COVER PLATE LINE 3M

- decorative cover plate LINE 3M
- in accordance with EN 60669-1



 OL40PW	 OL40SG
 OL40MW	 OL40NB
 OL40IW	 OL40IB
 OL40ES	 OL40AT
 OL40SB	 OL40TI
	 OL40SW









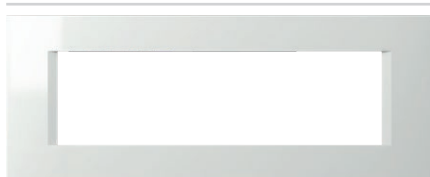

ПАНЕЛ LINE 4M

- декоративен панел LINE 4M
- в съответствие с EN 60669-1

COVER PLATE LINE 4M

- decorative cover plate LINE 4M
- in accordance with EN 60669-1



 OL70PW	 OL70SG
 OL70MW	 OL70NB
 OL70IW	 OL70IB
 OL70ES	 OL70AT
 OL70SB	 OL70TI
	 OL70SW







ПАНЕЛ LINE 7M

- декоративен панел LINE 7M
- в съответствие с EN 60669-1

COVER PLATE LINE 7M

- decorative cover plate LINE 7M
- in accordance with EN 60669-1



 OL71PW	 OL71AT
 OL71MW	 OL71TI
 OL71IW	
 OL71ES	
 OL71SB	

ПАНЕЛ LINE 2x7M

- декоративен панел LINE 2x7M
- в съответствие с EN 60669-1

COVER PLATE LINE 2x7M

- decorative cover plate LINE 2x7M
- in accordance with EN 60669-1



 OL10PW	 OL10SG
 OL10MW	 OL10NB
 OL10IW	 OL10IB
 OL10ES	 OL10AT
 OL10SB	 OL10TI
	 OL10SW









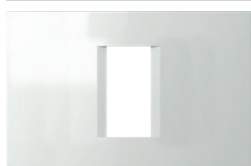

ПАНЕЛ LINE 1/2M

- декоративен панел LINE 1/2M
- в съответствие с EN 60669-1

COVER PLATE LINE 1/2M

- decorative cover plate LINE 1/2M
- in accordance with EN 60669-1



 OL13PW	 OL13SG
 OL13MW	 OL13NB
 OL13IW	 OL13IB
 OL13ES	 OL13AT
 OL13SB	 OL13TI
	 OL13SW









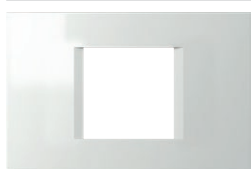

ПАНЕЛ LINE 1/3M

- декоративен панел LINE 1/3M
- в съответствие с EN 60669-1

COVER PLATE LINE 1/3M

- decorative cover plate LINE 1/3M
- in accordance with EN 60669-1



 OL23PW	 OL23SG
 OL23MW	 OL23NB
 OL23IW	 OL23IB
 OL23ES	 OL23AT
 OL23SB	 OL23TI
	 OL23SW

ПАНЕЛ LINE 2/3M

- декоративен панел LINE 2/3M
- в съответствие с EN 60669-1

COVER PLATE LINE 2/3M

- decorative cover plate LINE 2/3M
- in accordance with EN 60669-1

базов
basic

PW снежнобял цвят
polar white

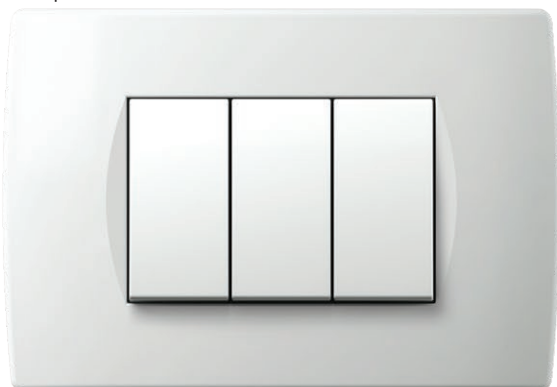

IW слонова кост
ivory white

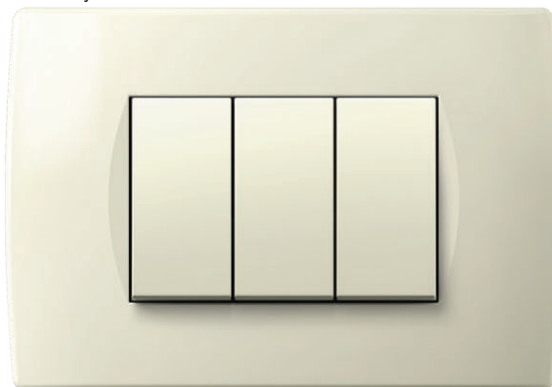

ES сребрист цвят с анодизирано покритие
elox silver

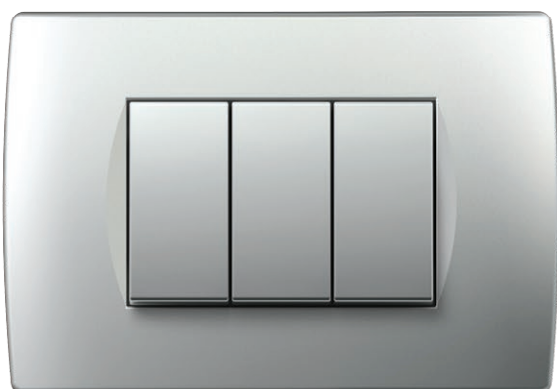

SB сензорен бутон, черен
soft touch black



AT антрацит
anthracite



MW Бял матов цвят
matte white

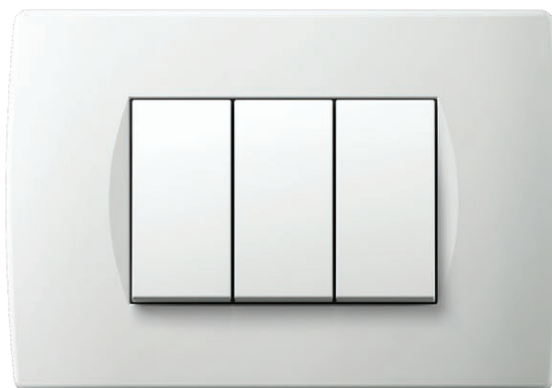

COVER PLATES SOFT OS

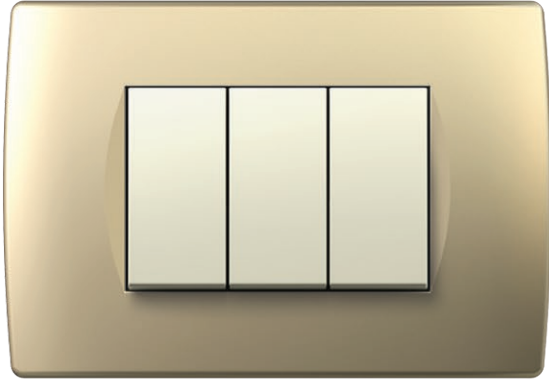
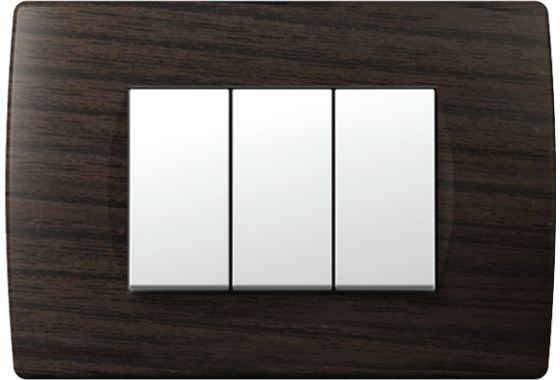
декор
decorSG пясъчнозлатист
sand goldNB тъмночерен
night blackTI титан
titaniumWE венге
wengeWW орех
walnut



OS30



PW

тип type	описание description	размер size	цвет colour																											
OS10	ПАНЕЛ SOFT COVER PLATE SOFT	1/2M	<table border="0"> <tr> <td></td> <td>PW</td> <td>снежнобял цвят polar white</td> <td></td> <td>SG</td> <td>пясъчнозлатист sand gold</td> <td></td> <td>WW</td> <td>орех walnut</td> </tr> </table>		PW	снежнобял цвят polar white		SG	пясъчнозлатист sand gold		WW	орех walnut																		
	PW	снежнобял цвят polar white		SG	пясъчнозлатист sand gold		WW	орех walnut																						
OS13	ПАНЕЛ SOFT COVER PLATE SOFT	1/3M	<table border="0"> <tr> <td></td> <td>MW</td> <td>Бял матов цвят matte white</td> <td></td> <td>NB</td> <td>тъмночерен night black</td> <td></td> <td>WE</td> <td>венге wenge</td> </tr> </table>		MW	Бял матов цвят matte white		NB	тъмночерен night black		WE	венге wenge																		
	MW	Бял матов цвят matte white		NB	тъмночерен night black		WE	венге wenge																						
OS20	ПАНЕЛ SOFT COVER PLATE SOFT	2M	<table border="0"> <tr> <td></td> <td>IW</td> <td>слонова кост ivory white</td> <td></td> <td>AT</td> <td>антрацит anthracite</td> <td></td> <td></td> <td></td> </tr> <tr> <td></td> <td>ES</td> <td>сребрист цвят с eloxirano покритие</td> <td></td> <td>TI</td> <td>титан titanium</td> <td></td> <td></td> <td></td> </tr> <tr> <td></td> <td>SB</td> <td>soft touch black черен</td> <td></td> <td></td> <td></td> <td></td> <td></td> <td></td> </tr> </table>		IW	слонова кост ivory white		AT	антрацит anthracite					ES	сребрист цвят с eloxirano покритие		TI	титан titanium					SB	soft touch black черен						
	IW	слонова кост ivory white		AT	антрацит anthracite																									
	ES	сребрист цвят с eloxirano покритие		TI	титан titanium																									
	SB	soft touch black черен																												



	OS20PW		OS20SG
	OS20MW		OS20NB
	OS20IW		OS20AT
	OS20ES		OS20TI
	OS20SB		OS20WW
			OS20WE

ПАНЕЛ SOFT 2M

- декоративен панел SOFT 2M
- в съответствие с EN 60669-1

COVER PLATE SOFT 2M

- decorative cover plate SOFT 2M
- in accordance with EN 60669-1



	OS24PW		OS24SG
	OS24MW		OS24NB
	OS24IW		OS24AT
	OS24ES		OS24TI
	OS24SB		OS24WW
			OS24WE

ПАНЕЛ SOFT 2x2M

- декоративен панел SOFT 2x2M
- хоризонтален или вертикален монтаж
- в съответствие с EN 60669-1

COVER PLATE SOFT 2x2M

- decorative cover plate SOFT 2x2M
- horizontal or vertical mounting
- in accordance with EN 60669-1

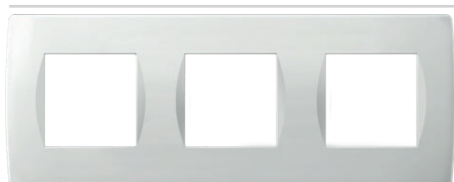

	OS26PW		OS26SG
	OS26MW		OS26NB
	OS26IW		OS26AT
	OS26ES		OS26TI
	OS26SB		OS26WW
			OS26WE

ПАНЕЛ SOFT 3x2M

- декоративен панел SOFT 3x2M
- хоризонтален или вертикален монтаж
- в съответствие с EN 60669-1

COVER PLATE SOFT 3x2M

- decorative cover plate SOFT 3x2M
- horizontal or vertical mounting
- in accordance with EN 60669-1



	OS28PW		OS28SG
	OS28MW		OS28NB
	OS28IW		OS28AT
	OS28ES		OS28TI
	OS28SB		OS28WW
			OS28WE

ПАНЕЛ SOFT 4x2M

- декоративен панел SOFT 4x2M
- хоризонтален или вертикален монтаж
- в съответствие с EN 60669-1

COVER PLATE SOFT 4x2M

- decorative cover plate SOFT 4x2M
- horizontal or vertical mounting
- in accordance with EN 60669-1

COVER PLATES SOFT OS



 OS30PW	 OS30SG
 OS30MW	 OS30NB
 OS30IW	 OS30AT
 OS30ES	 OS30TI
 OS30SB	 OS30WW
	 OS30WE



ПАНЕЛ SOFT 3M

- декоративен панел SOFT 3M
- в съответствие с EN 60669-1

COVER PLATE SOFT 3M

- decorative cover plate SOFT 3M
- in accordance with EN 60669-1



 OS40PW	 OS40SG
 OS40MW	 OS40NB
 OS40IW	 OS40AT
 OS40ES	 OS40TI
 OS40SB	 OS40WW
	 OS40WE









ПАНЕЛ SOFT 4M

- декоративен панел SOFT 4M
- в съответствие с EN 60669-1

COVER PLATE SOFT 4M

- decorative cover plate SOFT 4M
- in accordance with EN 60669-1



 OS70PW	 OS70SG
 OS70MW	 OS70NB
 OS70IW	 OS70AT
 OS70ES	 OS70TI
 OS70SB	 OS70WW
	 OS70WE







ПАНЕЛ SOFT 7M

- декоративен панел SOFT 7M
- в съответствие с EN 60669-1

COVER PLATE SOFT 7M

- decorative cover plate SOFT 7M
- in accordance with EN 60669-1



 OS71PW	 OS71AT
 OS71MW	 OS71TI
 OS71IW	
 OS71ES	
 OS71SB	





ПАНЕЛ SOFT 2x7M

- декоративен панел SOFT 2x7M
- в съответствие с EN 60669-1

COVER PLATE SOFT 2x7M

- decorative cover plate SOFT 2x7M
- in accordance with EN 60669-1



 OS72PW	 OS72SG
 OS72IW	 OS72AT
 OS72ES	 OS72TI
 OS72SB	

ПАНЕЛ SOFT 2x7M

- декоративен панел SOFT 2x7M
панел с надпис
- в съответствие с EN 60669-1

COVER PLATE SOFT 2x7M

- decorative cover plate SOFT 2x7M
with inscription plate
- in accordance with EN 60669-1



 OS10PW	 OS10SG
 OS10MW	 OS10NB
 OS10IW	 OS10AT
 OS10ES	 OS10TI
 OS10SB	 OS10WW
	 OS10WE









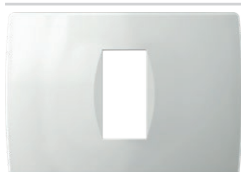

ПАНЕЛ SOFT 1/2M

- декоративен панел SOFT 1/2M
- в съответствие с EN 60669-1

COVER PLATE SOFT 1/2M

- decorative cover plate SOFT 1/2M
- in accordance with EN 60669-1



 OS13PW	 OS13SG
 OS13MW	 OS13NB
 OS13IW	 OS13AT
 OS13ES	 OS13TI
 OS13SB	 OS13WW
	 OS13WE

ПАНЕЛ SOFT 1/3M

- декоративен панел SOFT 1/3M
- в съответствие с EN 60669-1

COVER PLATE SOFT 1/3M

- decorative cover plate SOFT 1/3M
- in accordance with EN 60669-1

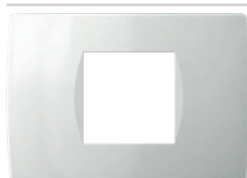

 OS23PW	 OS23SG
 OS23MW	 OS23NB
 OS23IW	 OS23AT
 OS23ES	 OS23TI
 OS23SB	 OS23WW
	 OS23WE

ПАНЕЛ SOFT 2/3M

- декоративен панел SOFT 2/3M
- в съответствие с EN 60669-1

COVER PLATE SOFT 2/3M

- decorative cover plate SOFT 2/3M
- in accordance with EN 60669-1

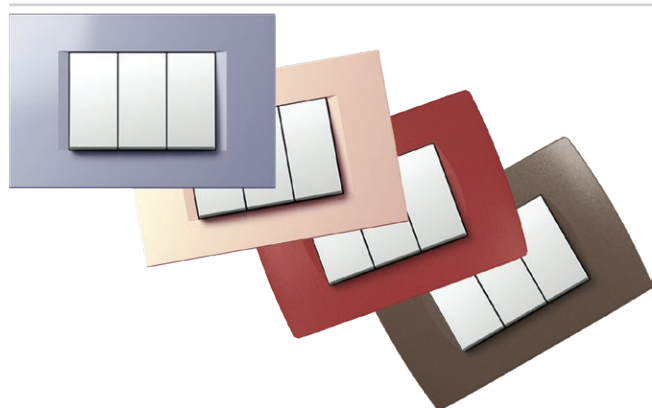











ДЕКОРИРАНЕ НА ПАНЕЛИ

- когато поръчвате големи количества, декоративните панели могат да бъдат изработени в избрания от вас цвят
- подходящо за панели OL, OS

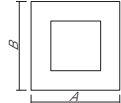
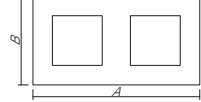
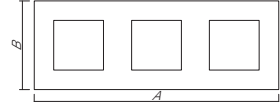
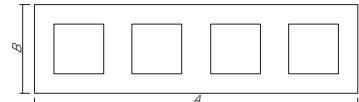
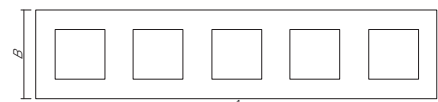
COVER PLATES DECORATIONS

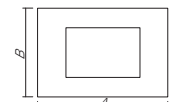
- when ordering large quantities, cover plates can be made in the colour of your choice
- suitable for cover plates OL, OS

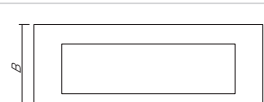
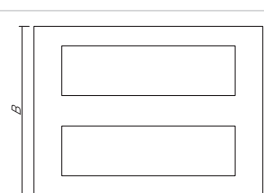
F R A M E S

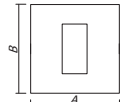
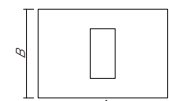
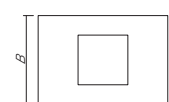
	 MODUL LINE A x B	 MODUL SOFT A x B	 MODUL PURE A x B
2M 	80 x 80 mm	84 x 84 mm	93 x 90 mm
2x2M 	151 x 80 mm	155 x 84 mm	164 x 90 mm
3x2M 	222 x 80 mm	226 x 84 mm	235 x 90 mm
4x2M 	293 x 80 mm	297 x 84 mm	304 x 90 mm
5x2M 	364,1 x 80 mm		
			
3M 	122 x 80 mm	122 x 84 mm	134 x 90 mm
4M 	149 x 80 mm	144 x 84 mm	157 x 90 mm
7M 	207 x 80 mm	212 x 84 mm	224 x 90 mm
2x7M 	215 x 159 mm	212 x 158 mm	
			
1/2M 	80 x 80 mm	84 x 84 mm	
1/3M 	122 x 80 mm	122 x 84 mm	134 x 90 mm
2/3M 	122 x 80 mm	122 x 84 mm	134 x 90 mm

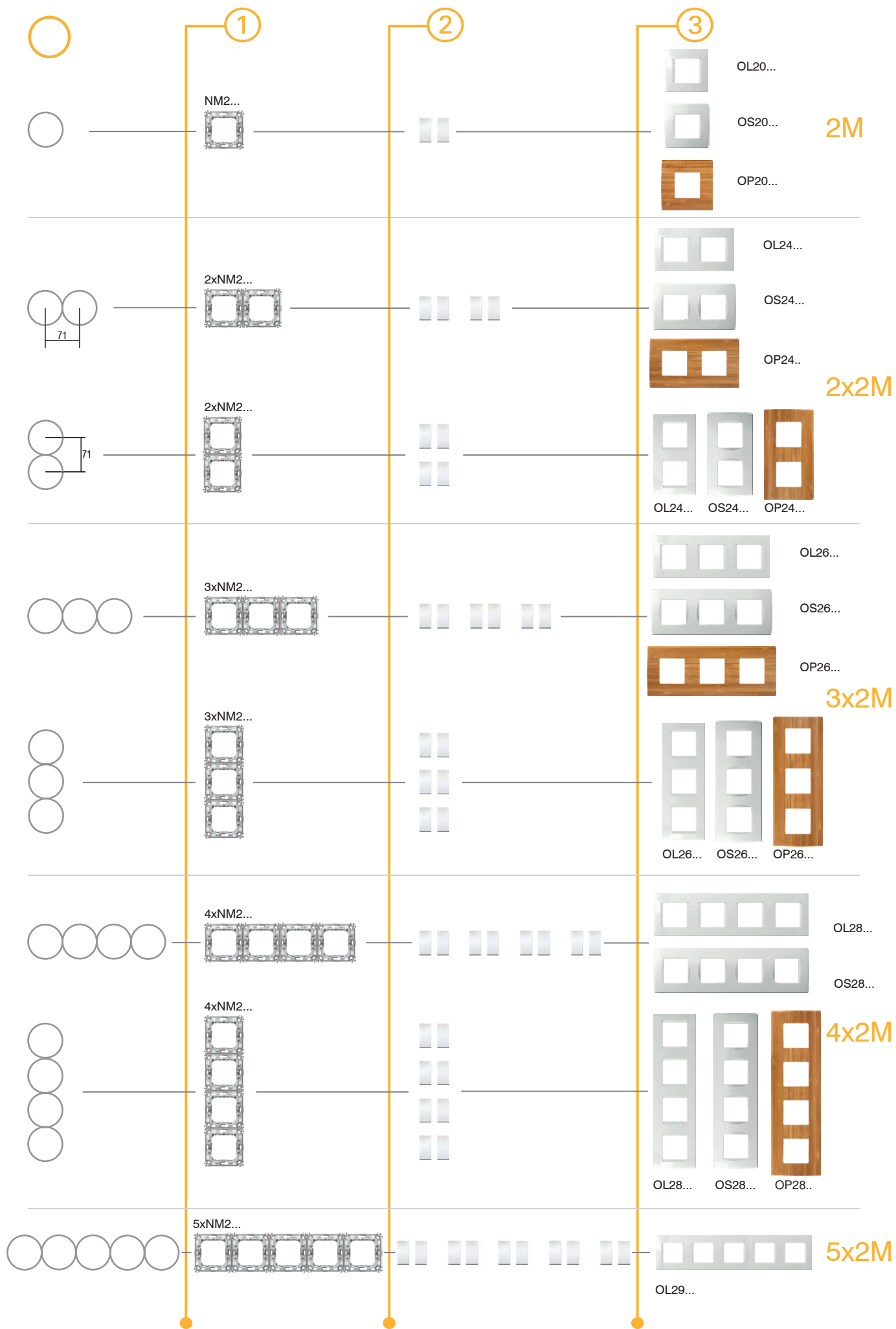

C O M B I N A T I O N S

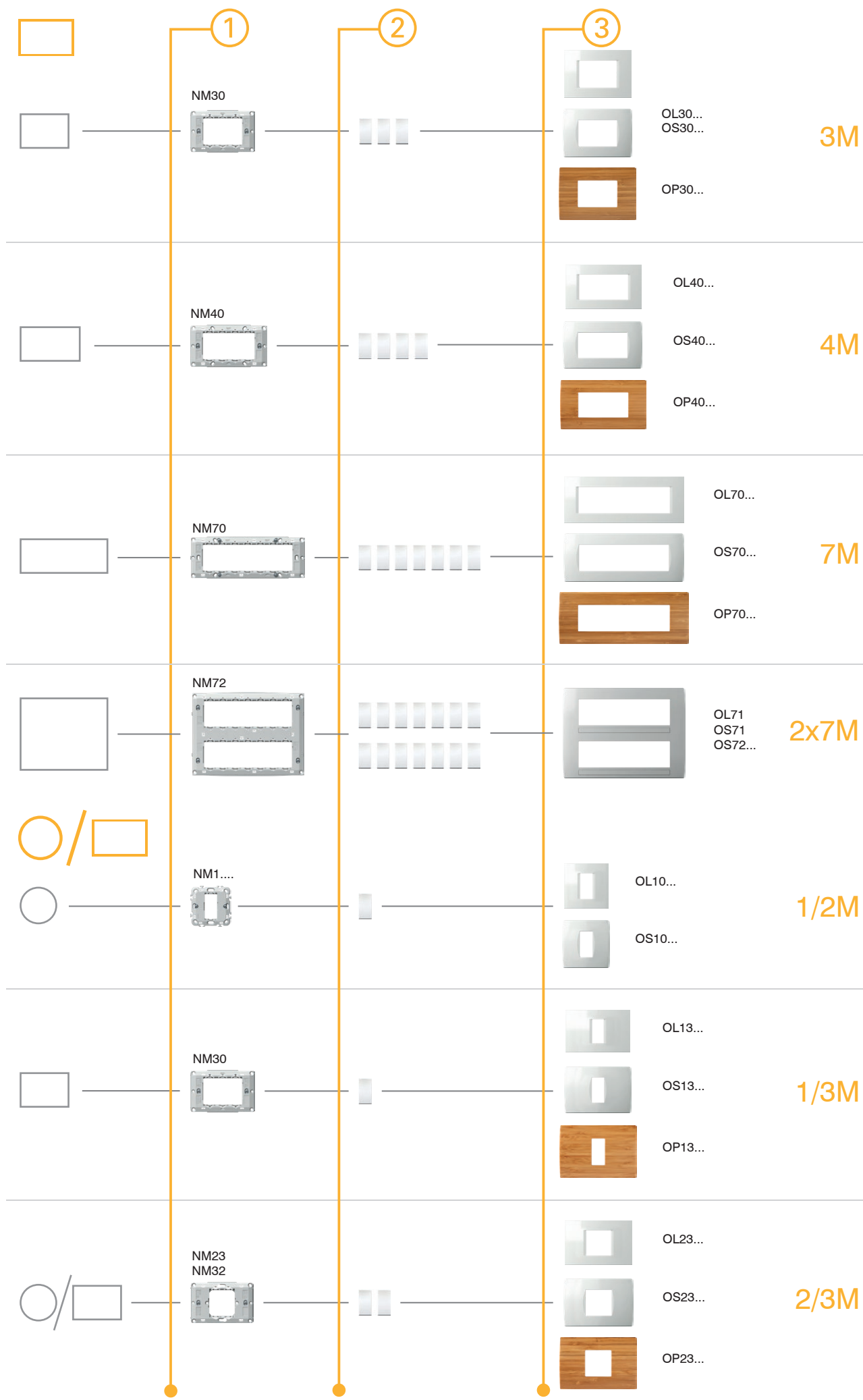

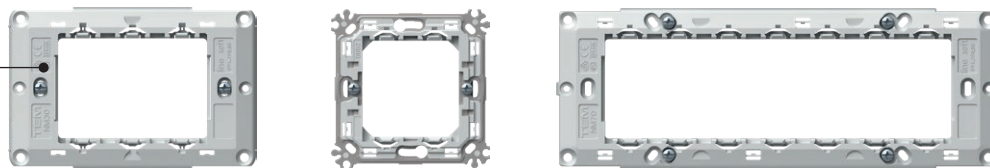

NM30

тип type	описание description	размер size
NM10	МОНТАЖНА РАМКА С ЩИПКИ MOUNTING FRAME WITH CLAWS	1/2M
NM11	МОНТАЖНА РАМКА БЕЗ ВИНТОВЕ MOUNTING FRAME WITHOUT SCREWS	1/2M
NM20	МОНТАЖНА РАМКА С ЩИПКИ MOUNTING FRAME WITH CLAWS	2M
...



МОНТАЖНА РАМКА С ЩИПКИ 2M

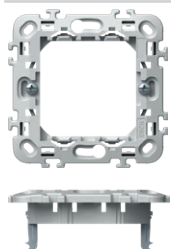

NM20

- монтаж на рамка 2M с крачета
- за монтаж на конзоли Ø60 (DE.) с крачета
- възможни са хоризонтални или вертикални комбинации 2x2M, 3x2M и 4x2M
- подходяща за слобяване с панели LINE и SOFT
- в съответствие с EN 60669-1

MOUNTING FRAME WITH CLAWS 2M

- mounting frame 2M with claws
- for mounting on boxes Ø60 (DE..) with claws
- possible horizontal or vertical combinations 2x2M, 3x2M and 4x2M
- suitable for assembling with cover plates LINE and SOFT
- in accordance with EN 60669-1

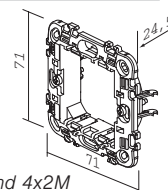

МОНТАЖНА РАМКА БЕЗ ВИНТОВЕ 2M

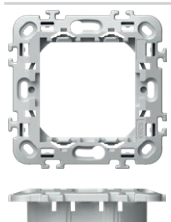

NM21

- монтаж на рамка 2M без винтове и без крачета
- за монтаж на конзоли Ø60 (HE., BE.) с винтове
- възможни са хоризонтални или вертикални комбинации 2x2M, 3x2M и 4x2M
- подходяща за слобяване с панели LINE и SOFT
- в съответствие с EN 60669-1

MOUNTING FRAME WITHOUT SCREWS 2M

- mounting frame 2M without screws and without claws
- for mounting on boxes Ø60 (HE..., BE..) with screws
- possible horizontal or vertical combinations 2x2M, 3x2M and 4x2M
- suitable for assembling with cover plates LINE and SOFT
- in accordance with EN 60669-1

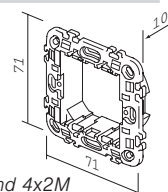

МЕТАЛНА МОНТАЖНА РАМКА С ЩИПКИ 2M

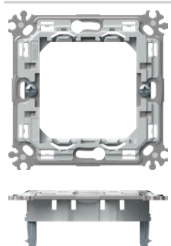

NM24

- метална монтажна рамка 2M с крачета – твърда версия
- за монтаж на конзоли Ø60 (DE.) с крачета
- възможни са хоризонтални или вертикални комбинации 2x2M, 3x2M и 4x2M
- подходяща за слобяване с панели PURE, LINE и SOFT
- в съответствие с EN 60669-1

MOUNTING FRAME METAL WITH CLAWS 2M

- metal mounting frame 2M with claws - stiff version
- for mounting on boxes Ø60 (DE..) with claws
- possible horizontal or vertical combinations 2x2M, 3x2M and 4x2M
- suitable for assembling with cover plates PURE, LINE and SOFT
- in accordance with EN 60669-1

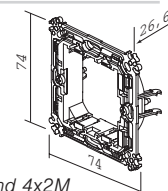

МЕТАЛНА МОНТАЖНА РАМКА БЕЗ ВИНТОВЕ 2M

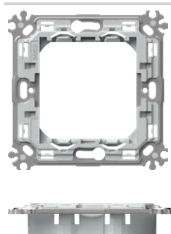

NM25

- метална монтажна рамка без винтове и без крачета – твърда версия
- за монтаж в конзоли Ø60 (HE..., BE...) с винтове
- възможни са хоризонтални или вертикални комбинации 2x2M, 3x2M и 4x2M
- подходяща за слобяване с панели PURE, LINE и SOFT
- в съответствие с EN 60669-1

MOUNTING FRAME METAL WITHOUT SCREWS 2M

- metal mounting frame 2M without screws and without claws - stiff version
- for mounting in boxes Ø60 (HE..., BE...) with screws
- possible horizontal or vertical combinations 2x2M, 3x2M and 4x2M
- suitable for assembling with cover plates PURE, LINE and SOFT
- in accordance with EN 60669-1

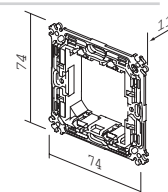

M O U N T I N G F R A M E S N M



МОНТАЖНА РАМКА С ЩИПКИ 1/2M

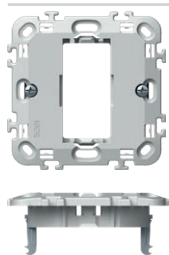

NM10

- монтажна рамка 1/2M с крачета
- за монтаж на конзоли Ø60 (DE.) с крачета
- подходяща за сглобяване с панели LINE и SOFT
- в съответствие с EN 60669-1

MOUNTING FRAME WITH CLAWS 1/2M

- mounting frame 1/2M with claws
- for mounting on boxes Ø60 (DE..) with claws
- suitable for assembling with cover plates LINE and SOFT
- in accordance with EN 60669-1

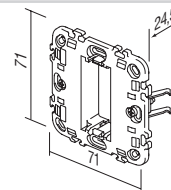

МОНТАЖНА РАМКА БЕЗ ВИНТОВЕ 1/2M

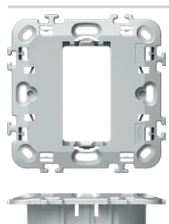

NM11

- монтажна рамка 1/2M без винтове и без крачета
- за монтаж на конзоли Ø60 (HE., BE.) с винтове
- подходяща за сглобяване с панели LINE и SOFT
- в съответствие с EN 60669-1

MOUNTING FRAME WITHOUT SCREWS 1/2M

- mounting frame 1/2M without screws and without claws
- for mounting on boxes Ø60 (HE., BE..) with screws
- suitable for assembling with cover plates LINE and SOFT
- in accordance with EN 60669-1

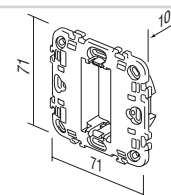

МОНТАЖНА РАМКА С ЩИПКИ 2/3M

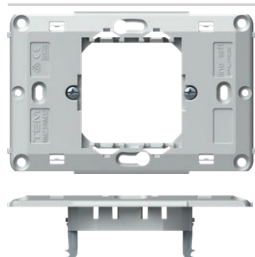

NM23

- монтажна рамка 2/3M с крачета
- за монтаж на конзоли Ø60 (DE.) с крачета
- подходяща за сглобяване с панели PURE, LINE и SOFT
- в съответствие с EN 60669-1

MOUNTING FRAME WITH CLAWS 2/3M

- mounting frame 2/3M with claws
- for mounting on boxes Ø60 (DE..) with claws
- suitable for assembling with cover plates PURE, LINE and SOFT
- in accordance with EN 60669-1

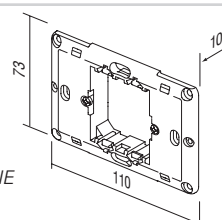

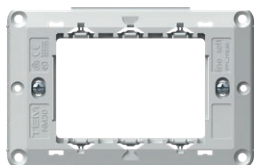

NM30

МОНТАЖНА РАМКА С ВИНТОВЕ 3М

- монтажна рамка 3М с винтове
- за монтаж в правоъгълни конзоли 3М
- подходяща за сглобяване с панели PURE, LINE и SOFT
- в съответствие с EN 60669-1

MOUNTING FRAME WITH SCREWS 3M

- mounting frame 3M with screws
- for mounting on rectangular boxes 3M
- suitable for assembling with cover plates PURE, LINE and SOFT
- in accordance with EN 60669-1

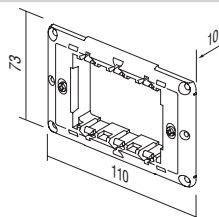

NM40

МОНТАЖНА РАМКА С ВИНТОВЕ 4М

- монтажна рамка 4М с винтове
- за монтаж в правоъгълни конзоли 4М
- подходяща за сглобяване с панели PURE, LINE и SOFT
- в съответствие с EN 60669-1

MOUNTING FRAME WITH SCREWS 4M

- mounting frame 4M with screws
- for mounting on rectangular boxes 4M
- suitable for assembling with cover plates PURE, LINE and SOFT
- in accordance with EN 60669-1

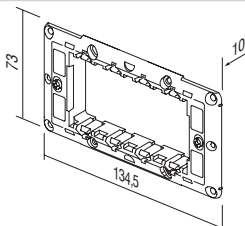

NM70

МОНТАЖНА РАМКА С ВИНТОВЕ 7М

- монтажна рамка 7М с винтове
- за монтаж в правоъгълни конзоли 7М
- подходяща за сглобяване с панели PURE, LINE и SOFT
- в съответствие с EN 60669-1

MOUNTING FRAME WITH SCREWS 7M

- mounting frame 7M with screws
- for mounting on rectangular boxes 7M
- suitable for assembling with cover plates 2x 7M
- in accordance with EN 60669-1

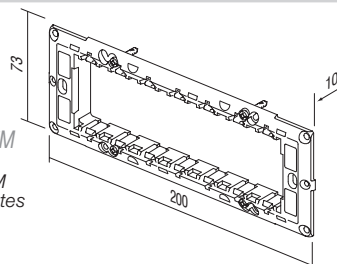

NM72

МОНТАЖНА РАМКА С ВИНТОВЕ 2x7М

- монтажна рамка с винтове 2x7М
- за монтаж в правоъгълни конзоли 2x7М
- подходяща за сглобяване с панел 2x7М
- в съответствие с EN 60669-1

MOUNTING FRAME WITH SCREWS 2x7M

- mounting frame 2x7M with screws
- for mounting on rectangular boxes 2x7M
- suitable for assembling with cover plates 2x 7M
- in accordance with EN 60669-1

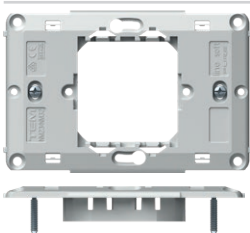
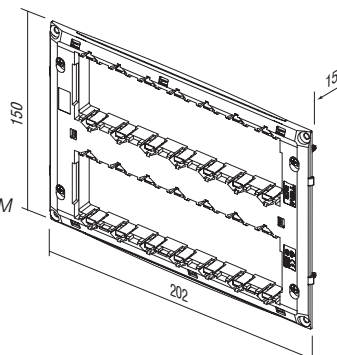

NM32

МОНТАЖНА РАМКА С ВИНТОВЕ 2/3М

- монтажна рамка 2/3М с винтове
- за монтаж в правоъгълни конзоли 3М
- подходяща за сглобяване с панели PURE, LINE и SOFT
- в съответствие с EN 60669-1

MOUNTING FRAME WITH SCREWS 2/3M

- mounting frame 2/3M with screws
- for mounting on rectangular boxes 3M
- suitable for assembling with cover plates PURE, LINE and SOFT
- in accordance with EN 60669-1

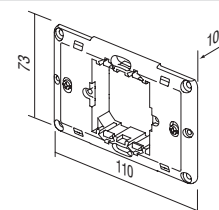



126



134



142



144





КУТТИ

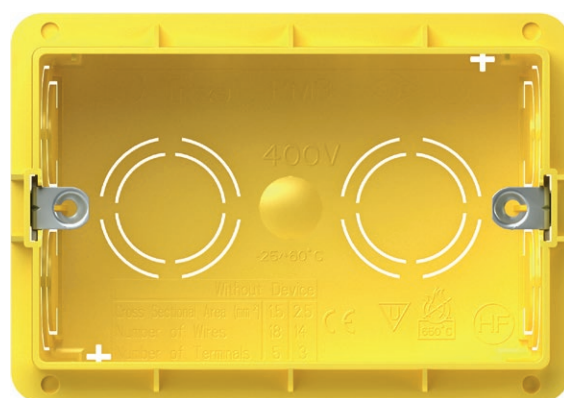

TEM



DE12



HE11



BE10

тип type	описание description	размер size
DE10	КРЪГЛИ КОНЗОЛИ ЗА ТУХЛЕНИ СТЕНИ ROUND BOX BRICK	SM60-01
HE10	КРЪГЛИ КОНЗОЛИ ЗА КУХИ СТЕНИ ROUND BOX HOLLOW WALL	SM68X40
BE10	КРЪГЛИ КОНЗОЛИ ЗА СТЕНИ ОТ БЕТОН ROUND BOX CONCRETE	
⋮	⋮	⋮

КРЪГЛИ КОНЗОЛИ ЗА ТУХЛЕНИ СТЕНИ SM60-01



DE10

- Ø60, дълбочина 40 mm
- 650° C, 500 V~
- в съответствие с IEC 60670-1
- без съдържание на халоген
- възможност за монтиране на монтажната рамка с винтове с Ø 3 mm

ROUND BOX BRICK SM60-01

- Ø60, depth 40mm
- 650°C, 500V~
- in accordance with IEC 60670-1
- halogen free
- option of mounting the mounting frame with Ø 3 mm screws

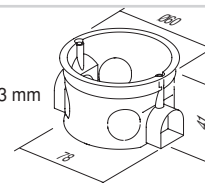

КРЪГЛИ ДЪЛБОКИ КОНЗОЛИ ЗА ТУХЛЕНИ СТЕНИ SM60-06



DE11

- Ø60, дълбочина 60 mm
- 650° C, 500 V~
- в съответствие с IEC 60670-1
- без съдържание на халоген
- възможност за монтиране на монтажната рамка с винтове с Ø 3 mm

ROUND BOX BRICK DEEP SM60-06

- Ø60, depth 60mm
- 650°C, 500V~
- in accordance with IEC 60670-1
- halogen free
- option of mounting the mounting frame with Ø 3 mm screws

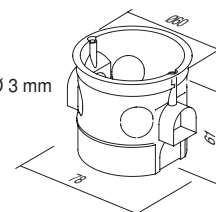

COMBI-CLIP SM60-03



DE30

- за вертикално закрепване на SM60-06 или SM60-01 на разстояние 91 mm
- в съответствие с IEC 60670-1
- без съдържание на халоген

COMBI-CLIP SM60-03

- for vertical fitting of boxes SM60-06 or SM60-01 on distance 91 mm
- in accordance with IEC 60670-1
- halogen free

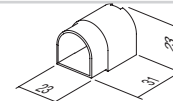

COMBI-CLIP SM60-04

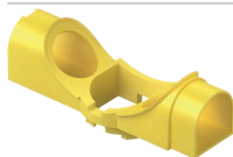

DE31







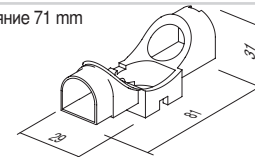



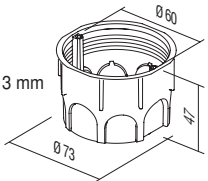

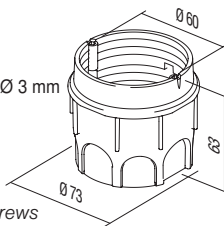

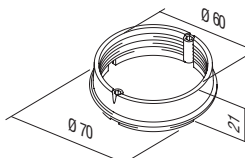
- за хоризонтално закрепване на SM60-06 или SM60-01 на разстояние 71 mm
- в съответствие с IEC 60670-1
- без съдържание на халоген

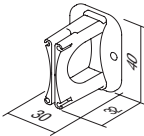
COMBI-CLIP SM60-04

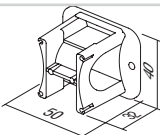
- for horizontal fitting of boxes SM60-06 or SM60-01 on distance 71mm
- in accordance with IEC 60670-1
- halogen free

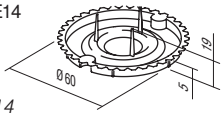

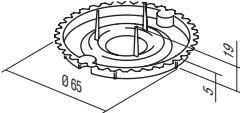
R O U N D B O X E S

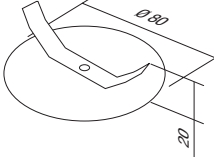
	DE12	КРЪГЛИ КОНЗОЛИ ЗА ТУХЛЕНИ СТЕНИ MD65-46	<ul style="list-style-type: none"> - Ø65, дълбочина 46 mm - 650° C, 500 V~ - в съответствие с IEC 60670-1 - без съдържание на халоген - възможност за монтиране на монтажната рамка с винтове с Ø 3 mm 	
		ROUND BOX BRICK MD65-46	<ul style="list-style-type: none"> - Ø65, depth 46mm - 650°C, 500V~ - in accordance with IEC 60670-1 - halogen free - option of mounting the mounting frame with Ø 3 mm screws 	
	DE13	КРЪГЛИ ДЪЛБОКИ КОНЗОЛИ ЗА ТУХЛЕНИ СТЕНИ MD65-60	<ul style="list-style-type: none"> - Ø65/60, дълбочина 62 mm - 650° C, 500 V~ - в съответствие с IEC 60670-1 - без съдържание на халоген - възможност за монтиране на монтажната рамка с винтове с Ø 3 mm 	
		ROUND BOX BRICK DEEP MD65-60	<ul style="list-style-type: none"> - Ø65/60, depth 62mm - 650°C, 500V~ - in accordance with IEC 60670-1 - halogen free - option of mounting the mounting frame with Ø 3 mm screws 	
	DE14	ДОПЪЛНИТЕЛЕН ДЕТАЙЛ ЗА MD65-46	<ul style="list-style-type: none"> - Ø65/60, дълбочина 17mm - 650° C, 500 V~ - в съответствие с IEC 60670-1 - без съдържание на халоген 	
		ADDITIONAL PIECE FOR MD65-46	<ul style="list-style-type: none"> - Ø65/60, depth 17mm - 650°C, 500V~ - in accordance with IEC 60670-1 - halogen free 	
	DE32	COMBI-CLIP MD65-71	<ul style="list-style-type: none"> - за закрепване на конзоли MD65 на разстояние 71 mm - в съответствие с IEC 60670-1 - без съдържание на халоген 	
		COMBI-CLIP MD65-71	<ul style="list-style-type: none"> - for fitting of boxes MD65 on distance 71mm - in accordance with IEC 60670-1 - halogen free 	
	DE33	COMBI-CLIP MD65-91	<ul style="list-style-type: none"> - за закрепване на конзоли MD65 на разстояние 91 mm - в съответствие с IEC 60670-1 - без съдържание на халоген 	
		COMBI-CLIP MD65-91	<ul style="list-style-type: none"> - for fitting of boxes MD65 on distance 91mm - in accordance with IEC 60670-1 - halogen free 	
	DE20	BOX COVER PROTECTIVE 60	<ul style="list-style-type: none"> - защитно капаче за конзола за конзола Ø60 DE10, DE11, DE13, DE14 - в съответствие с IEC 60670-1 - за защитаване на конзолата по време на измазване 	
		BOX COVER PROTECTIVE 60	<ul style="list-style-type: none"> - protective cover for box Ø60 for DE10, DE11, DE13, DE14 - in accordance with IEC 60670-1 - box protection during plastering 	
	DE21	BOX COVER PROTECTIVE 65	<ul style="list-style-type: none"> - защитно капаче за конзола за конзола Ø65 DE12 - в съответствие с IEC 60670-1 - за защитаване на конзолата по време на измазване 	
		BOX COVER PROTECTIVE 65	<ul style="list-style-type: none"> - protective cover for box Ø65 for DE12 - in accordance with IEC 60670-1 - box protection during plastering 	
	DE22	BOX COVER SM60	<ul style="list-style-type: none"> - декоративно капаче за конзоли Ø60 - в съответствие с IEC 60670-1 - без съдържание на халоген 	
		BOX COVER DECORATIVE SM60	<ul style="list-style-type: none"> - decorative cover for boxes Ø60 - in accordance with IEC 60670-1 - halogen free 	



указания за сглобяване /
assembly instructions

разстояние между конзолите /
distance between boxes: 71 mm

разстояние между конзолите /
distance between boxes: 91 mm

DE10,11

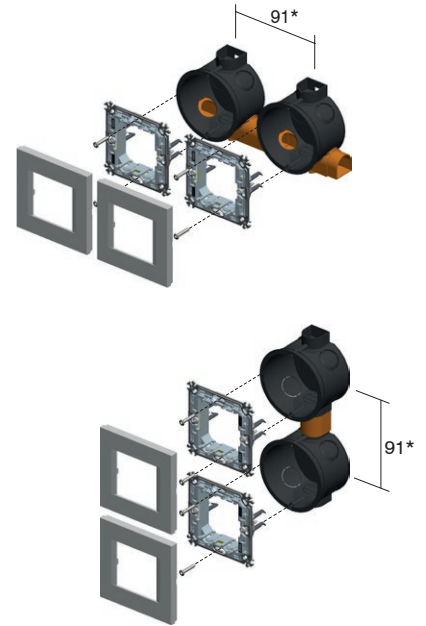
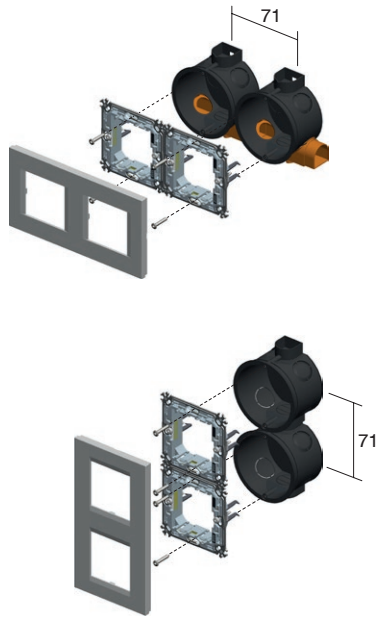
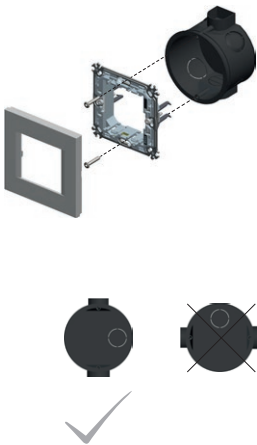

DE12,13

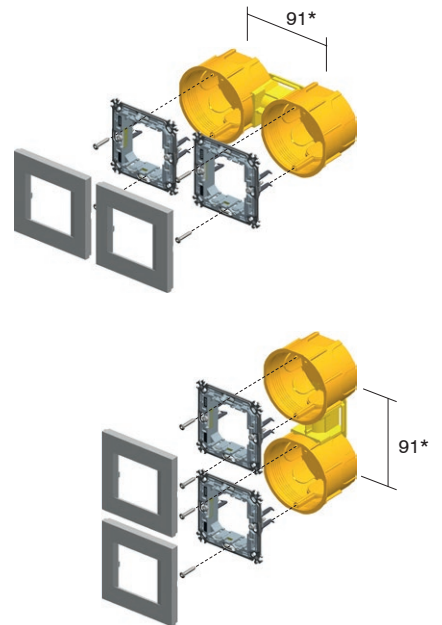
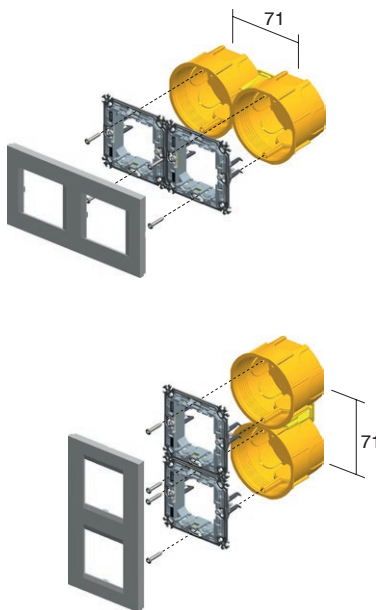
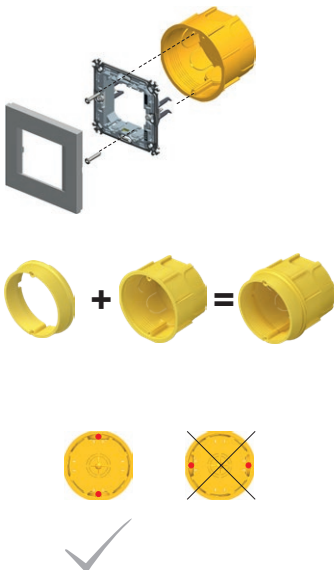

* за панели PURE минималното разстояние между конзолите е 100 mm
* for PURE cover plates the minimum distance between boxes is 100mm

R O U N D B O X E S



DE10,11



DE12,13



NM20



NM24



DE10,11



DE12,13



NM10



DE10,11



DE12,13



NM23



71

2xDE10,11 + 2xDE31



2xDE12,13 + 1xDE32



2xNM20



2xNM24



2xDE10,11 2xDE12,13 + 1xDE32



2xNM20



2xNM24



3xDE10,11 + 3xDE31



3xDE12,13 + 2xDE32



3xNM20



3xNM24

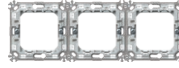

3xDE10,11 3xDE12,13 + 2xDE32

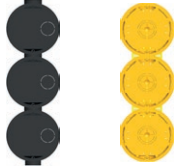

3xNM20



3xNM24



4xDE10,11 + 4xDE31



4xDE12,13 + 3xDE32



4xNM20



4xNM24



4xDE10,11 4xDE12,13 + 3xDE32

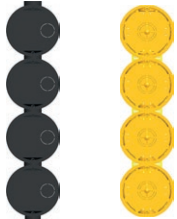

4xNM20



4xNM24



5xDE10,11



5xNM20



5xDE12,13 + 4xDE32



5xNM24



КРЪГЛА КОНЗОЛА ЗА КУХИ СТЕНИ SM68x40



HE10

- Ø60, дълбочина 40 mm
- прорязване на отвор Ø68
- 850° C, 400 V~
- в съответствие с IEC 60670-1
- монтаж с крачета
- без съдържание на халоген
- монтиране на монтажната рамка с винтове с Ø 3 mm

ROUND BOX HOLLOW WALL SM68x40

- Ø60, depth 40mm
- cutting hole Ø68
- 850°C, 400V~
- in accordance with IEC 60670-1
- mounting with claws
- halogen free
- mounting the mounting frame with Ø 3 mm screws

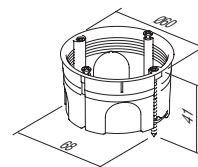

КРЪГЛА КОНЗОЛА ЗА КУХИ СТЕНИ SM68x55



HE11

- Ø60, дълбочина 55 mm
- прорязване на отвор Ø68
- 850° C, 400 V~
- в съответствие с IEC 60670-1
- монтаж с крачета
- без съдържание на халоген
- монтиране на монтажната рамка с винтове с Ø 3 mm

ROUND BOX HOLLOW WALL SM68x55

- Ø60, depth 55mm
- cutting hole Ø68
- 850°C, 400V~
- in accordance with IEC 60670-1
- mounting with claws
- halogen free
- mounting the mounting frame with Ø 3 mm screws

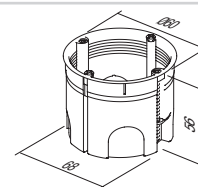

КРЪГЛИ КОНЗОЛИ ЗА СТЕНИ ОТ БЕТОН



BE10

- Ø60 mm, дълбочина 49 mm
- 650° C, 500 V~
- в съответствие с IEC 60670-1
- без съдържание на халоген
- монтиране на монтажната рамка с винтове с Ø 3 mm

ROUND BOX CONCRETE

- Ø60mm, depth 49mm
- 650°C, 500V~
- in accordance with IEC 60670-1
- halogen free
- mounting the mounting frame with Ø 3 mm screws

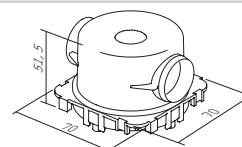

КРЪГЛИ ДЪЛБОКИ КОНЗОЛИ ЗА СТЕНИ ОТ БЕТОН



BE11

- Ø60 mm, дълбочина 58mm
- 650° C, 500 V~
- в съответствие с IEC 60670-1
- без съдържание на халоген
- монтиране на монтажната рамка с винтове с Ø 3 mm

ROUND BOX CONCRETE DEEP

- Ø60mm, depth 58mm
- 650°C, 500V~
- in accordance with IEC 60670-1
- halogen free
- mounting the mounting frame with Ø 3 mm screws

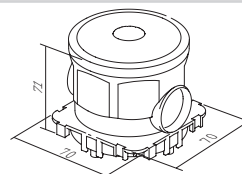

ЗАДНА ОПОРА ЗА КОНЗОЛА ЗА СТЕНИ ОТ БЕТОН



BE20

- за поддържане на конзоли за бетон с дистанционен профил BM82 срещу стената
- в съответствие с IEC 60670-1
- без съдържание на халоген

COUNTER BOX SUPPORT CONCRETE

- to support concrete boxes with discance profile BM82 for extreme loads
- in accordance with IEC 60670-1
- halogen free

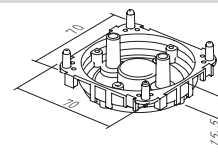

PIPE STOPPER CONCRETE BOX 16



BE21

- за закрепване на инсталационна тръба към конзола
- в съответствие с IEC 60670-1
- без съдържание на халоген

PIPE STOPPER CONCRETE BOX 16

- for firming installation pipe to box
- in accordance with IEC 60670-1
- halogen free

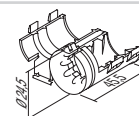

R O U N D B O X E S

кухи стени / hollow walls



бетон / concrete



указания за сглобяване /
assembly instructions

разстояние между конзолите /
distance between boxes: 71 mm

разстояние между конзолите /
distance between boxes: 91 mm

HE10,11

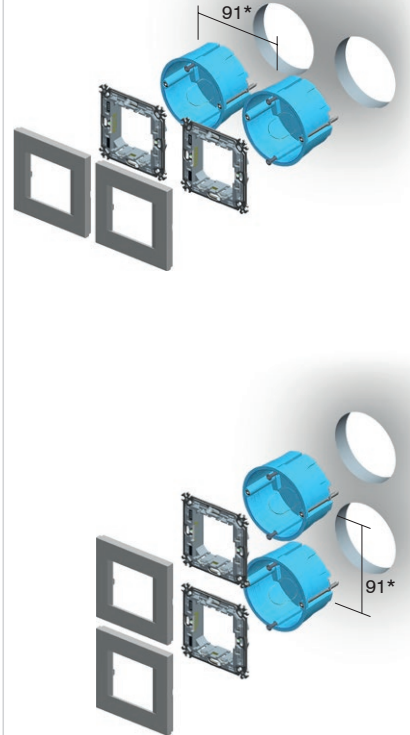
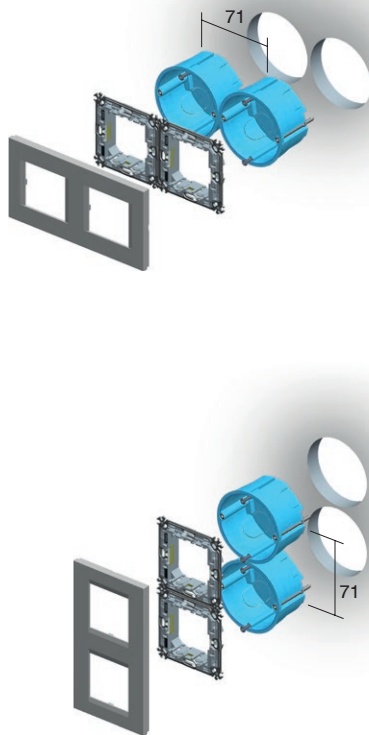
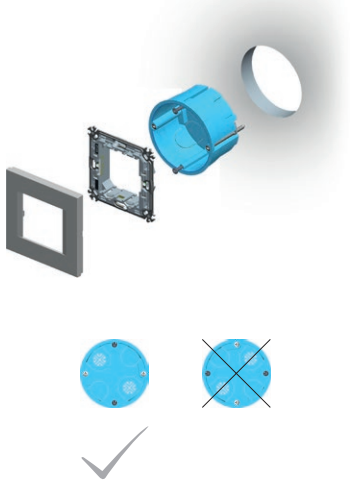

BE10

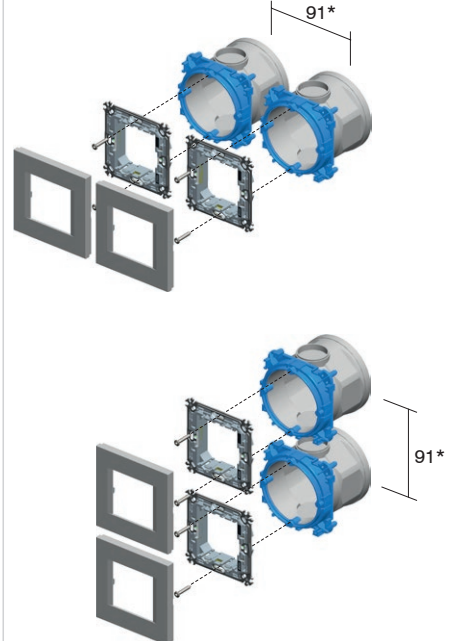
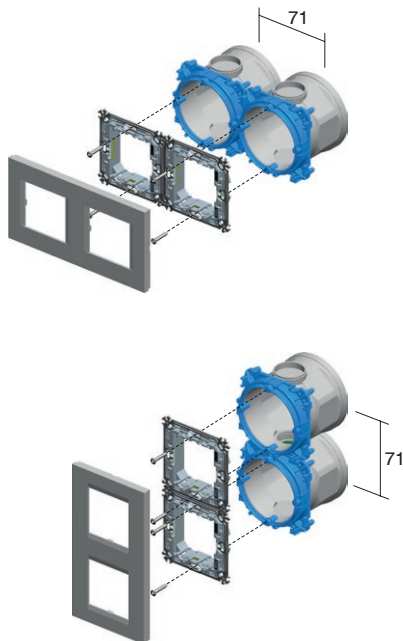
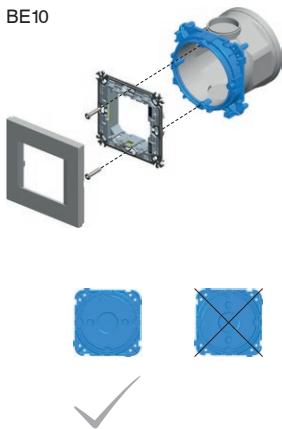

* за панелите PURE минималното разстояние между конзолите е 100 mm
* for PURE cover plates the minimum distance between boxes is 100mm

К Р Ъ Г Л И К О Н З О Л И

кухи стени/ hollow walls



бетон/ concrete



HE10,11



BE10,11



NM21



NM25



2M

HE10,11



BE10,11



NM11



1/2M

2xHE10,11



2xBE10,11



2xNM21



2xNM25



2x2M

HE10,11



BE10,11



NM32



2/3M

2xHE10,11



2xBE10,11



2xNM21



2xNM25



5xHE10,11



5xNM21



5xBE10,11



5xNM25



5x2M

3xHE10,11

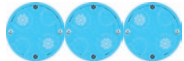

3xBE10,11



3xNM21



3xNM25



3x2M

3xHE10,11



3xBE10,11



3xNM21



3xNM25



4xHE10,11



4xBE10,11



4xNM21



4xNM25



4x2M

4xHE10,11



4xBE10,11



4xNM21



4xNM25



R O U N D B O X E S

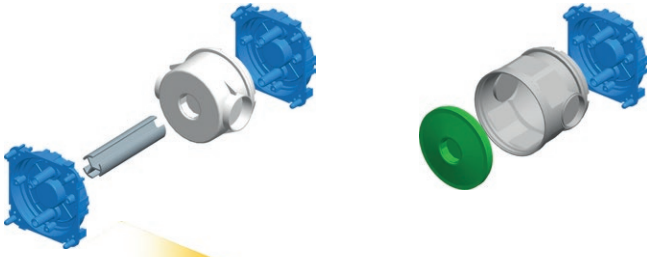

указания за сглобяване /
assembly instructions

1

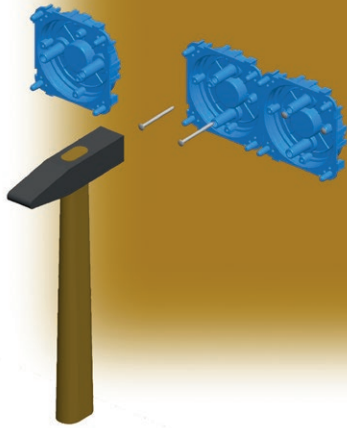

2

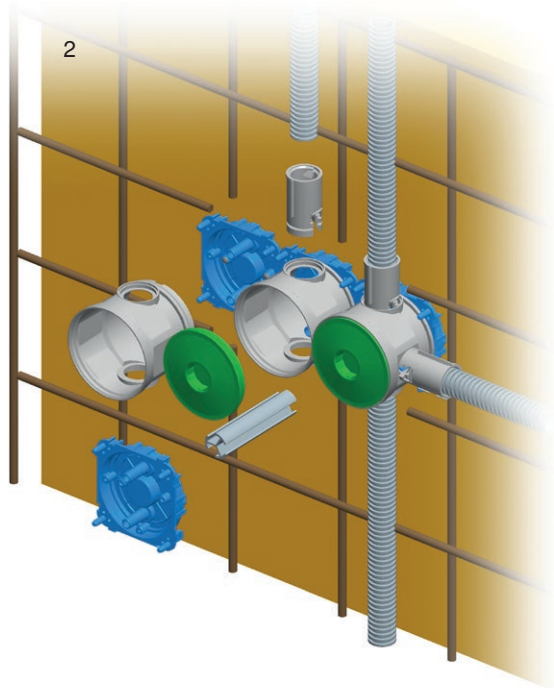

3

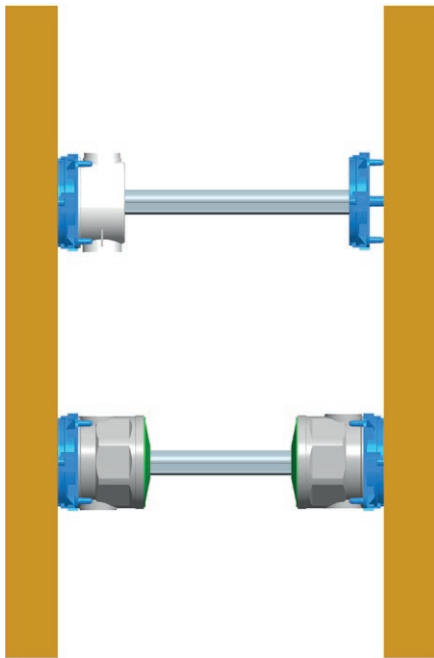

4

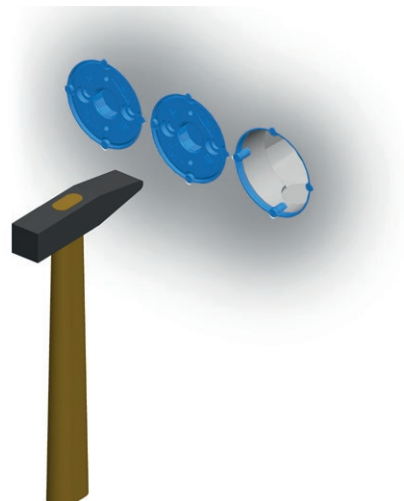

П Р А В О Ъ Г Ъ Л Н И К О Н З О Л И



DM30



HM30



BM30

тип type	описание description	размер size
DM30	ПРАВОЪГЪЛНА КОНЗОЛА ЗА ТУХЛЕНИ СТЕНИ <i>RECTANGULAR BOX BRICK</i>	PM3
HM30	ПРАВОЪГЪЛНА КОНЗОЛА ЗА КУХИ СТЕНИ <i>RECTANGULAR BOX HOLLOW WALL</i>	VM3
BM30	ПРАВОЪГЪЛНА КОНЗОЛА ЗА СТЕНИ ОТ БЕТОН <i>RECTANGULAR BOX CONCRETE</i>	BM3
...

ПРАВОЪГЪЛНА КОНЗОЛА ЗА ТУХЛЕНИ СТЕНИ PM3



DM30

- размер 3М, дълбочина 49 mm
- 650° C, 400V~
- в съответствие с IEC 60670-1
- без съдържание на халоген

RECTANGULAR BOX BRICK PM3

- size 3M, depth 49mm
- 650°C, 400V~
- in accordance with IEC 60670-1
- halogen free

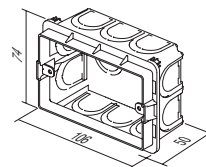

ПРАВОЪГЪЛНА КОНЗОЛА ЗА ТУХЛЕНИ СТЕНИ PM3-65



DM31

- размер 3М, дълбочина 65mm
- 650° C, 400V~
- в съответствие с IEC 60670-1
- без съдържание на халоген

RECTANGULAR BOX BRICK PM3-65

- size 3M, depth 65mm
- 650°C, 400V~
- in accordance with IEC 60670-1
- halogen free

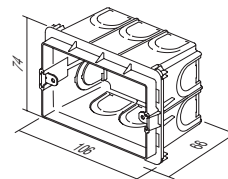

ПРАВОЪГЪЛНА КОНЗОЛА ЗА ТУХЛЕНИ СТЕНИ PM4



DM40

- размер 4М, дълбочина 49 mm
- 650° C, 400V~
- в съответствие с IEC 60670-1
- без съдържание на халоген

RECTANGULAR BOX BRICK PM4

- size 4M, depth 49mm
- 650°C, 400V~
- in accordance with IEC 60670-1
- halogen free

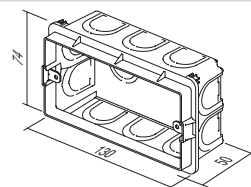

ПРАВОЪГЪЛНА КОНЗОЛА ЗА ТУХЛЕНИ СТЕНИ PM4-65



DM41

- размер 4М, дълбочина 65mm
- 650° C, 400V~
- в съответствие с IEC 60670-1
- без съдържание на халоген

RECTANGULAR BOX BRICK PM4-65

- size 4M, depth 65mm
- 650°C, 400V~
- in accordance with IEC 60670-1
- halogen free

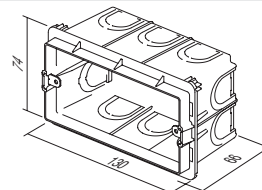

R E C T A N G U L A R B O X E S



DM70

ПРАВОЪГЪЛНА КОНЗОЛА ЗА ТУХЛЕНИ СТЕНИ PM7

- размер 7М, дълбочина 49 mm
- 650° C, 400V~
- в съответствие с IEC 60670-1
- без съдържание на халоген

RECTANGULAR BOX BRICK PM7

- size 7M, depth 49mm
- 650°C, 400V~
- in accordance with IEC 60670-1
- halogen free

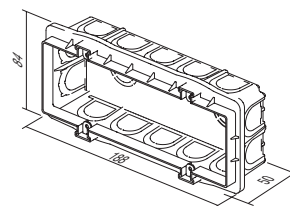

DM71

ПРАВОЪГЪЛНА КОНЗОЛА ЗА ТУХЛЕНИ СТЕНИ PM7-65

- размер 7М, дълбочина 65mm
- 650° C, 400V~
- в съответствие с IEC 60670-1
- без съдържание на халоген

RECTANGULAR BOX BRICK PM7-65

- size 7M, depth 65mm
- 650°C, 400V~
- in accordance with IEC 60670-1
- halogen free

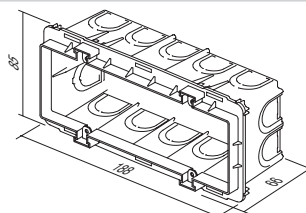

DM72

ПРАВОЪГЪЛНА КОНЗОЛА ЗА ТУХЛЕНИ СТЕНИ PM72-65

- размер 2x7М, дълбочина 64mm
- 650° C, 400V~
- в съответствие с IEC 60670-1
- без съдържание на халоген

RECTANGULAR BOX BRICK PM72-65

- size 2x7M, depth 64mm
- 650°C, 400V~
- in accordance with IEC 60670-1
- halogen free

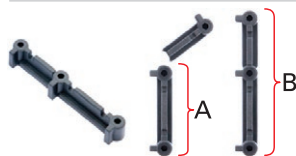
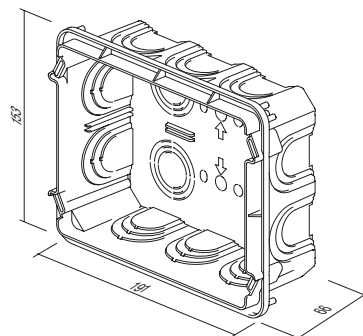

DM80

ДИСТАНЦИОНЕН ЕЛЕМЕНТ ЗА КОНЗОЛА PM

- за вертикален (A) и хоризонтален (B) монтаж на конзоли PM3, PM4 в PM7
- подходящ за декоративни панели LINE and SOFT (не за PURE)

DISTANCE PIECE FOR BOX PM

- for vertical (A) and horizontal (B) fitting of boxes PM3, PM4 and PM7
- suitable for Line and Soft decorative cover plates (not for PURE)

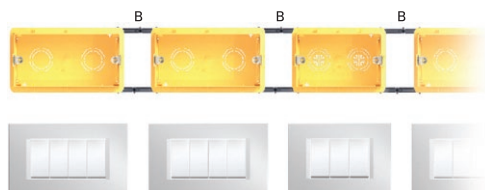
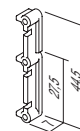

П Р А В О Ъ Г Ъ Л Н И К О Н З О Л И

BOX COVER PROTECTIVE PM3



DM33

- защитно капаче за конзола PM3
- в съответствие с IEC 60670-1
- без съдържание на халоген
- за защита на конзолата по време на измазване

BOX COVER PROTECTIVE PM3

- protective cover for box PM3
- in accordance with IEC 60670-1
- halogen free
- box protection during plastering

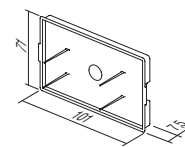

BOX COVER DECORATIVE PM3



DM34

- декоративно капаче за конзоли 3M
- винтовете са включени в доставката
- в съответствие с IEC 60670-1
- без съдържание на халоген

BOX COVER DECORATIVE PM3

- decorative cover for boxes 3M
- screws are included
- in accordance with IEC 60670-1
- halogen free

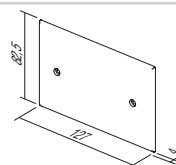

BOX COVER PROTECTIVE PM4



DM43

- защитно капаче за конзола PM4
- в съответствие с IEC 60670-1
- без съдържание на халоген
- за защита на конзолата по време на измазване

BOX COVER PROTECTIVE PM4

- protective cover for box PM4
- in accordance with IEC 60670-1
- halogen free
- box protection during plastering

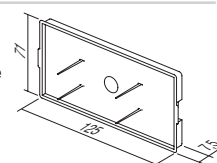

BOX COVER DECORATIVE PM4



DM44

- декоративно капаче за конзоли 4M
- винтовете са включени в доставката
- в съответствие с IEC 60670-1
- без съдържание на халоген

BOX COVER DECORATIVE PM4

- decorative cover for boxes 4M
- screws are included
- in accordance with IEC 60670-1
- halogen free

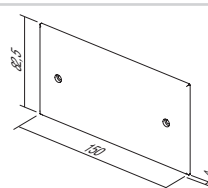

BOX COVER PROTECTIVE PM7

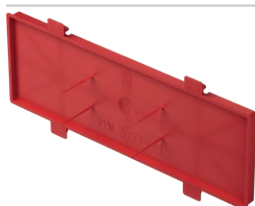

DM73

- защитно капаче за конзола PM7
- в съответствие с IEC 60670-1
- без съдържание на халоген
- за защита на конзолата по време на измазване

BOX COVER PROTECTIVE PM7

- protective cover for box PM7
- in accordance with IEC 60670-1
- halogen free
- box protection during plastering

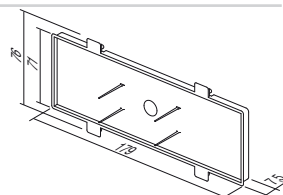

BOX COVER DECORATIVE PM7



DM74

- декоративно капаче за конзоли 7M
- винтовете са включени в доставката
- в съответствие с IEC 60670-1
- без съдържание на халоген

BOX COVER DECORATIVE PM7

- decorative cover for boxes 7M
- screws are included
- in accordance with IEC 60670-1
- halogen free

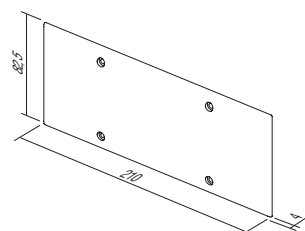

R E C T A N G U L A R B O X E S



DM75

BOX COVER DECORATIVE PM72

- декоративно капаче за конзоли 2x7M
- винтовете са включени в доставката
- в съответствие с IEC 60670-1

BOX COVER DECORATIVE PM72

- decorative cover for boxes 2x7M
- screws are included
- in accordance with IEC 60670-1

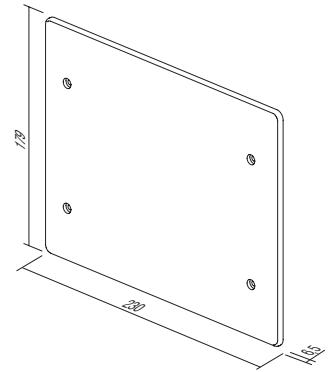

ПРАВЪЪГЪЛНА КОНЗОЛА ЗА КУХИ СТЕНИ VM3



HM30

- размер 3M, дълбочина 49 mm
- прорязване на отвор 2xØ68/45 mm
- 850° C, 400 V~
- в съответствие с IEC 60670-1
- без съдържание на халоген

RECTANGULAR BOX HOLLOW WALL VM3

- size 3M, depth 49mm
- cutting hole 2xØ68/45mm
- 850°C, 400V~
- in accordance with IEC 60670-1
- halogen free

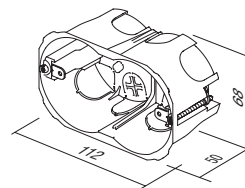

ПРАВЪЪГЪЛНА КОНЗОЛА ЗА КУХИ СТЕНИ VM4



HM40

- размер 4M, дълбочина 49 mm
- прорязване на отвор 2xØ68/70 mm
- 850° C, 400 V~
- в съответствие с IEC 60670-1
- без съдържание на халоген

RECTANGULAR BOX HOLLOW WALL VM4

- size 4M, depth 49mm
- cutting hole 2xØ68/70mm
- 850°C, 400V~
- in accordance with IEC 60670-1
- halogen free

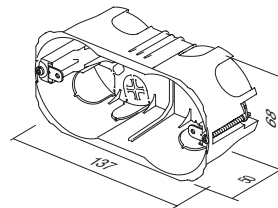

ПРАВЪЪГЪЛНА КОНЗОЛА ЗА КУХИ СТЕНИ VM7



HM70

- размер 7M, дълбочина 49 mm
- прорязване на отвор 2xØ68/120 mm
- 850° C, 400 V~
- в съответствие с IEC 60670-1
- без съдържание на халоген

RECTANGULAR BOX HOLLOW WALL VM7

- size 7M, depth 49mm
- cutting hole 2xØ68/120mm
- 850°C, 400V~
- in accordance with IEC 60670-1
- halogen free

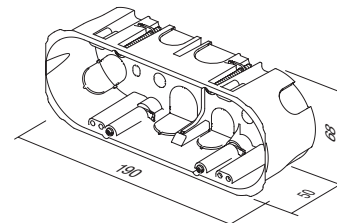

ПРАВЪЪГЪЛНА КОНЗОЛА ЗА КУХИ СТЕНИ VM72

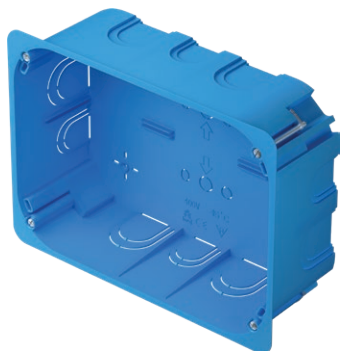

HM72

- размер 2x7M, дълбочина 63mm
- 850° C, 400 V~
- в съответствие с IEC 60670-1
- без съдържание на халоген

RECTANGULAR BOX HOLLOW WALL VM72

- size 2x7M, depth 63mm
- 850°C, 400V~
- in accordance with IEC 60670-1
- halogen free

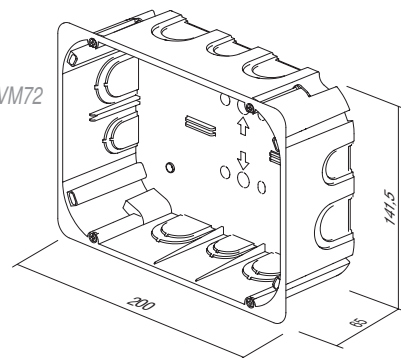

R E C T A N G U L A R B O X E S

ПРАВОЪГЪЛНА КОНЗОЛА ЗА СТЕНИ ОТ БЕТОН ВМ3



ВМ30

- размер 3М, дълбочина 60 mm
- 650° C, 400V~
- в съответствие с IEC 60670-1
- без съдържание на халоген

RECTANGULAR BOX CONCRETE BM3

- size 3M, depth 60mm
- 650°C, 400V~
- in accordance with IEC 60670-1
- halogen free

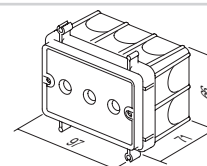

ПРАВОЪГЪЛНА КОНЗОЛА ЗА СТЕНИ ОТ БЕТОН ВМ4



ВМ40

- размер 4М, дълбочина 60 mm
- 650° C, 400V~
- в съответствие с IEC 60670-1
- без съдържание на халоген

RECTANGULAR BOX CONCRETE BM4

- size 4M, depth 60mm
- 650°C, 400V~
- in accordance with IEC 60670-1
- halogen free

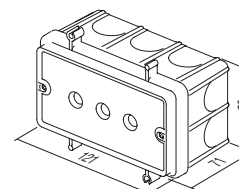

ПРАВОЪГЪЛНА КОНЗОЛА ЗА СТЕНИ ОТ БЕТОН ВМ7



ВМ70

- размер 7М, дълбочина 60 mm
- 650° C, 400V~
- в съответствие с IEC 60670-1
- без съдържание на халоген

RECTANGULAR BOX CONCRETE BM7

- size 7M, depth 60mm
- 650°C, 400V~
- in accordance with IEC 60670-1
- halogen free

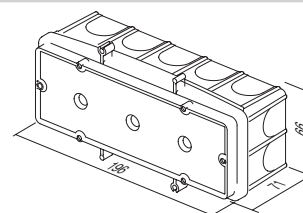

FIXING COMBI-CLIP ВМ



ВМ80

- за бързо закрепване правоъгълни конзоли ВМ върху подсилваща шина
- подходящо за пръти с диаметър до Ø8 mm

FIXING COMBI-CLIP ВМ

- for fast fixation of ВМ rectangular boxes on reinforcing bar
- suitable for bar diameter up to Ø8mm

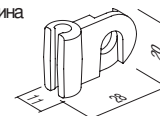

ДИСТАНЦИОНЕН ПРОФИЛ ЗА КОНЗОЛИ ВМ



ВМ82

- за поддържане на конзоли ВМ с опора върху стената
- дължина l=1 m, диаметър Ø20 mm

DISTANCE PROFIL FOR BOXES ВМ

- to support boxes ВМ with counter box support on opposite wall
- length l=1m, diameter Ø20mm

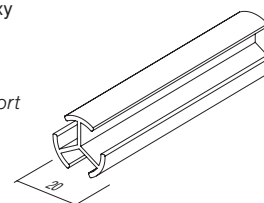

П Р А В О Ъ Г Ъ Л Н И К О Н З О Л И



тухла/ brick



кухи стени/ hollow walls



бетон/ concrete



DM30



NM30



HM30



3M

BM30



DM40



NM40



4M

HM40



BM40



DM70

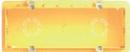

NM70



7M

HM70



BM70



DM72



NM72

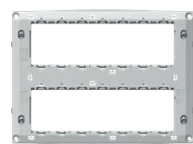

2x7M

HM72



DM30



NM32



2/3M

HM30



BM30



R E C T A N G U L A R B O X E S

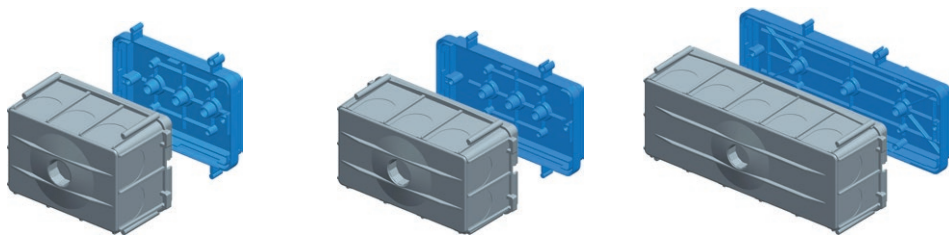

указания за сглобяване /
assembly instructions

1

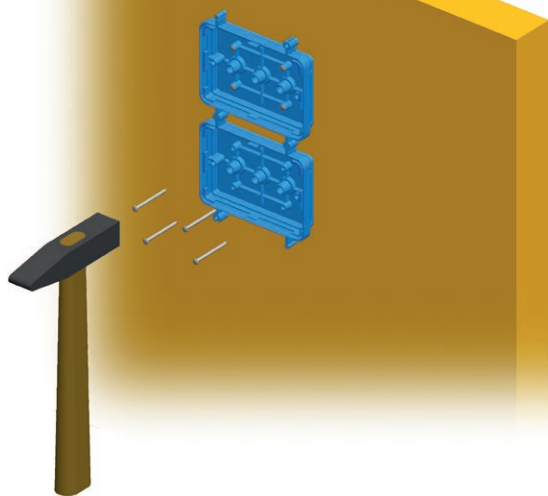

2

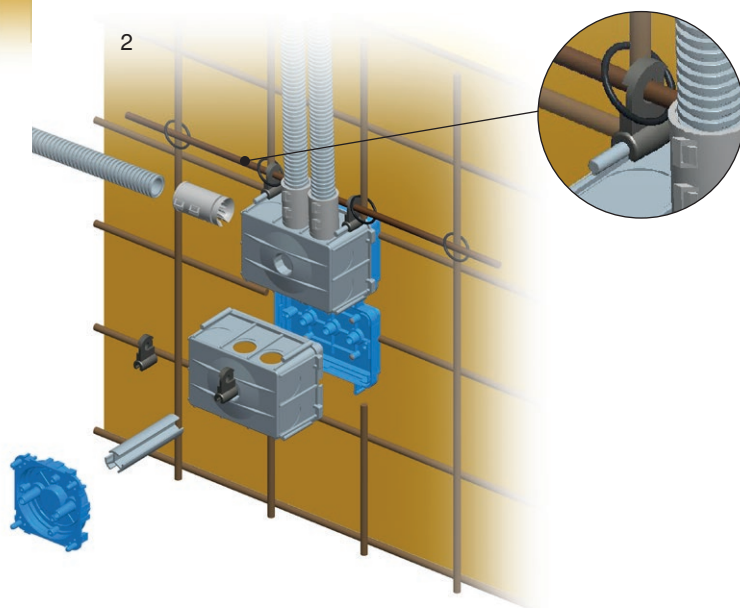

3

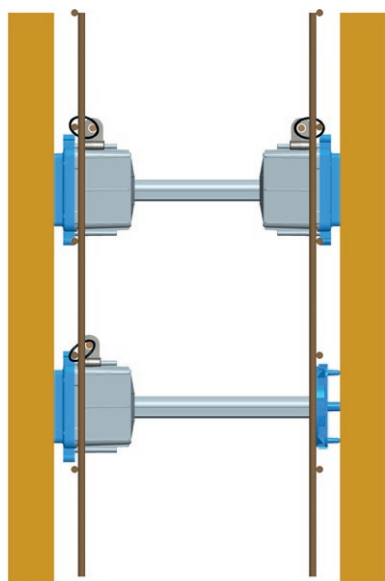

4

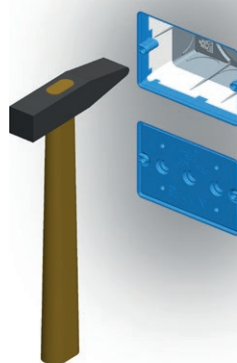

С Ъ Е Д И Н И Т Е Л Н И К У Т И И

КРЪГЛА СЪЕДИНИТЕЛНА КОНЗОЛА ЗА ТУХЛЕНИ СТЕНИ DSM78



DW10

- Ø78, дълбочина 40 mm
- 650° C, 500 V~
- в съответствие с IEC 60670-1 и IEC 60670-22
- без съдържание на халоген

CONNECTION ROUND BOX BRICK DSM78

- Ø78, depth 40mm
- 650°C, 500V~
- in accordance with IEC 60670-1 and IEC 60670-22
- halogen free

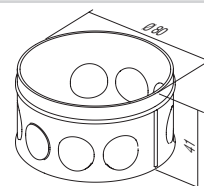

КРЪГЛА СЪЕДИНИТЕЛНА КОНЗОЛА ЗА КУХИ СТЕНИ SM78x45



HW10

- Ø78, дълбочина 45 mm
- прорязване на отвор Ø80
- 850° C, 400 V~
- в съответствие с IEC 60670-1 и IEC 60670-22
- монтаж с крачета
- без съдържание на халоген

CONNECTION ROUND BOX HOLLOW WALL SM78x45

- Ø78, depth 45mm
- cutting hole Ø80
- 850°C, 400V~
- in accordance with IEC 60670-1 and IEC 60670-22
- mounting with claws
- halogen free

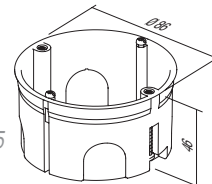

BOX COVER SM78



DE23

- декоративно капаче за конзоли Ø78
- в съответствие с IEC 60670-1 и IEC 60670-22
- без съдържание на халоген

BOX COVER DECORATIVE SM78

- decorative cover for boxes Ø78
- in accordance with IEC 60670-1 and IEC 60670-22
- halogen free

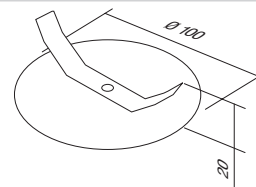

BOX COVER PROTECTIVE 78



DE24

- защитно капаче за конзола Ø78
- в съответствие с IEC 60670-1 и IEC 60670-22
- без съдържание на халоген

BOX COVER PROTECTIVE 78

- protective cover for box Ø78
- in accordance with IEC 60670-1 and IEC 60670-22
- halogen free

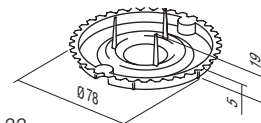

КВАДРАТНА СЪЕДИНИТЕЛНА КОНЗОЛА ЗА ТУХЛЕНИ СТЕНИ SM105x105



HW20

- размер 105x105mm, дълбочина 50 mm
- прорязване на отвор с приложения шаблон
- 850° C, 400 V~
- в съответствие с IEC 60670-1 и IEC 60670-22
- монтаж с крачета
- без съдържание на халоген

CONNECTION SQUARE BOX BRICK SM105x105

- size 105x105mm, depth 50mm
- cutting hole according to attached template
- 850°C, 400V~
- in accordance with IEC 60670-1 and IEC 60670-22
- mounting with claws
- halogen free

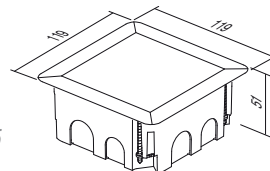

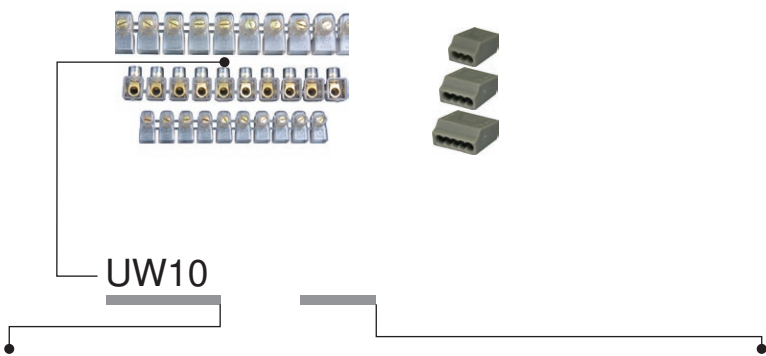

тип type	описание description	технически данни technical data	размер size	цвет colour
UW10	1 РЕД КЛЕМОРЕДИ ЗАТВОРЕНИ 1 ROW TERMINAL BLOCKS	2x2.5mm ²	10P	TS прозрачен transparent
UW11	1 РЕД КЛЕМОРЕДИ ЗАТВОРЕНИ 1 ROW TERMINAL BLOCKS	2x4mm ²	10P	CO цвет colour
UW12	1 РЕД КЛЕМОРЕДИ ЗАТВОРЕНИ 1 ROW TERMINAL BLOCKS	2x6mm ²	10P	WH бял цвет white
·	·	·	·	GY сив grey

1 РЕД КЛЕМОРЕДИ ЗАТВОРЕНИ



- 450 V~; 2x2,5 mm² ÷ 2x6 mm²
- термопласт PC, прозрачен
- брой полюси: 10

1 ROW TERMINAL BLOCKS CLOSED

- 450V~; 2x2.5mm² ÷ 2x6mm²
- thermoplast PC, transparent
- number of poles: 10

UW10TS	(NS12)	2x2.5mm ²	10P
UW11TS	(NS12)	2x4mm ²	10P
UW12TS	(NS12)	2x6mm ²	10P

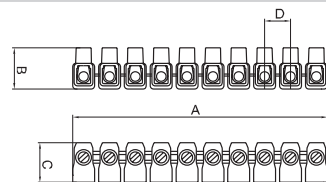

	A	B	C	D
2x2.5 □	110	17.5	17.5	11
2x4 □	128	21	19	12.5
2x6 □	146	21.5	22	15

1 РЕД КЛЕМОРЕДИ

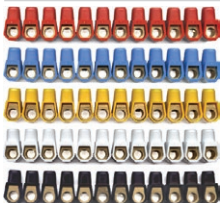

- 450 V~; 2x2,5 mm² ÷ 2x6 mm²
- термопласт PA
- предлага се в различни цветове
- брой полюси: 12

1 ROW TERMINAL BLOCKS

- 450V~; 2x2.5mm² ÷ 2x6mm²
- thermoplast PA
- available in different colours
- number of poles: 12

UW15CO	(NS12)	2x2.5mm ²	12P
UW16CO	(NS12)	2x4mm ²	12P
UW17CO	(NS12)	2x6mm ²	12P

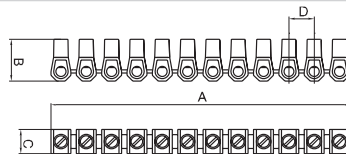

	A	B	C	D
2x2.5 □	110	16.4	9	10
2x4 □	118.8	19	10	10
2x6 □	129.8	21.3	11	11.8

2 РЕДА КЛЕМОРЕДИ PP

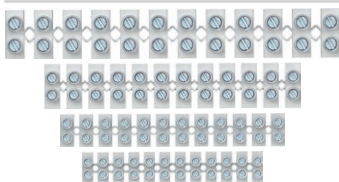

- 450 V~; 1 mm² ÷ 16 mm²
- термопласт полипропилен PP, бял
- за температури до 80°С
- брой полюси: 12

2 ROW TERMINAL BLOCKS PP

- 450V~; 1mm² ÷ 16mm²
- thermoplast polypropylene PP, white
- for temperatures up to 80°C
- number of poles: 12

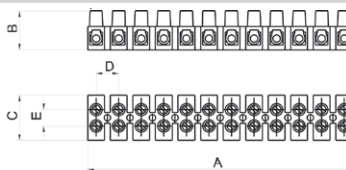

					A	B	C	D	E
UW29WHPP	1.0-4.0mm ²	24 A	450 V		94,9	13	16,6	8,1	6,4
UW30WHPP	1.5-6.0mm ²	32 A	450 V		116,5	14,9	18,9	10	7,3
UW31WHPP	2.5-10mm ²	41 A	450 V		133,8	17,3	23,4	11,5	10
UW32WHPP	4-16mm ²	76 A	450 V		174,5	20,7	25	15	11

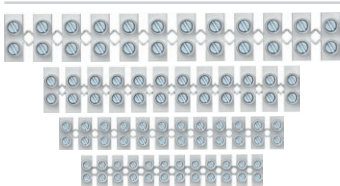

2 РЕДА КЛЕМОРЕДИ РА

- 450 V~; 1 mm² ÷ 16 mm²
- термопласт полиамид РА, бял
- за температури до 110° C
- брой полюси: 12

2 ROW TERMINAL BLOCKS PA

- 450V~; 1mm² ÷ 16mm²
- thermoplast polyamide PA, white
- for temperatures up to 110°C
- number of poles: 12

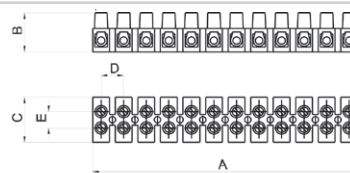

					A	B	C	D	E
UW25WHPA	1.0-4.0mm ²	24 A	450 V		93,6	13,4	16,2	8	6,4
UW26WHPA	1.5-6.0mm ²	32 A	450 V		117	15	18,6	10	7,3
UW27WHPA	2.5-10mm ²	41 A	450 V		132,8	17,3	22,2	11,5	10
UW28WHPA	4-16mm ²	76 A	450 V		173,9	20,8	25,2	15	11

СЪЕДИНИТЕЛИ С ВКАРВАНЕ НА ПРОВОДНИЦИТЕ



- 24 A 450 V~, термопласт РА, сив
- брой полюси: 3÷8
- контакти чрез вкарване 0,5÷1,5 mm², за твърди проводници
- в съответствие с EN 60998-1



PLUG-IN WIRE CONNECTORS

- 24A 450V~, thermoplast PA, grey
- number of poles: 3÷8
- plug-in contacts 0.5÷1.5mm², for rigide wires
- in accordance with EN 60998-1

UW40GY	PC153	1.5mm ²	3P	3P	A 12	B 18	C 9
UW41GY	PC155	1.5mm ²	5P	5P	17	18	9
UW42GY	PC158	1.5mm ²	8P	8P	26	18	9

СЪЕДИНИТЕЛИ С ВКАРВАНЕ НА ПРОВОДНИЦИТЕ



- 24 A 450 V~, термопласт РА, сив
- брой полюси: 3÷5
- контакти чрез вкарване 1,5÷2,5 mm², за твърди проводници
- в съответствие с EN 60998-1

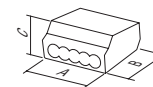

PLUG-IN WIRE CONNECTORS

- 24A 450V~, thermoplast PA, grey
- number of poles: 3÷5
- plug-in contacts 1.5÷2.5mm², for rigide wires
- in accordance with EN 60998-1

UW45GY	PC253	2.5mm ²	3P	3P	A 14	B 19	C 9
UW46GY	PC254	2.5mm ²	4P	4P	17	19	9
UW47GY	PC255	2.5mm ²	5P	5P	21	19	9

СЪЕДИНИТЕЛ С ВКАРВАНЕ НА ПРОВОДНИЦИТЕ



- 24 A 450 V~, термопласт РА, сив
- брой полюси: 2 (твърд проводник)+1 (мек проводник)
- контакти чрез вкарване 1,5÷2,5 mm²
- в съответствие с EN 60998-1

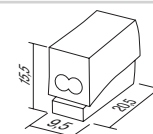

PLUG-IN WIRE CONNECTOR

- 24A 450V~, thermoplast PA, grey
- number of poles: 2 (rigide wire)+1 (soft wire)
- plug-in contacts 1.5÷2.5mm²
- in accordance with EN 60998-1

UW50WH	PC302	2.5mm ²	2/1P				
--------	-------	--------------------	------	--	--	--	--



MODUL
PURE



148



149



151

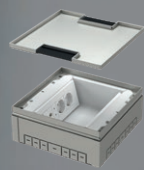

156

ДИСТРИБУЦИЯ



TEM

К О Н З О Л И С У В О I P 2 0 А С

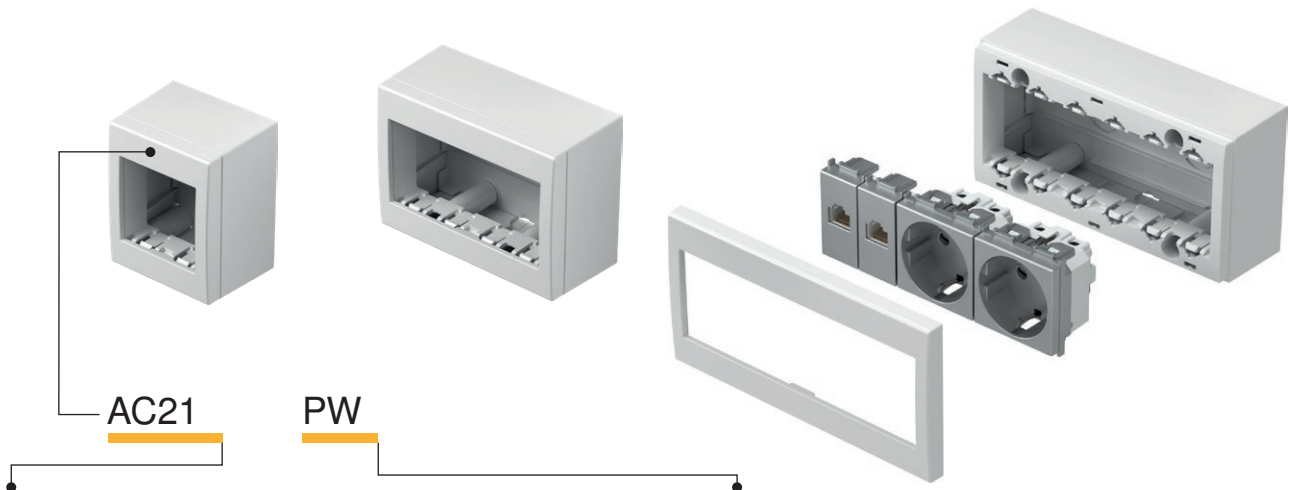

тип type	описание description	технически данни technical data	размер size	цвет colour
AC11	КОНЗОЛА NO CUBO СЪС ЗАДЕН КАПАК SURFACE MOUNT BOX WITH BACK SIDE COVER	IP20	1M	<input type="checkbox"/> PW снежнобял цвят polar white <input type="checkbox"/> ES сребрист цвят с анодизирано покритие elox silver
AC21	КОНЗОЛА NO CUBO СЪС ЗАДЕН КАПАК SURFACE MOUNT BOX WITH BACK SIDE COVER	IP20	2M	<input type="checkbox"/> IW слонова кост ivory white
AC41	КОНЗОЛА NO CUBO СЪС ЗАДЕН КАПАК SURFACE MOUNT BOX WITH BACK SIDE COVER	IP20	4M	

КОНЗОЛА NO CUBO СЪС ЗАДЕН КАПАК IP20 1M



- AC11PW
- AC11ES
- AC11IW

- конзола IP20 1M
- за външен монтаж на елементи
- подходяща за ключове SM
- в съответствие с EN 60669-1

- BOX NO CUBO WITH BACK SIDE COVER IP20 1M
- box IP20 1M
- for surface mounting of elements
- suitable to SM switches
- in accordance with EN 60669-1



КОНЗОЛА NO CUBO СЪС ЗАДЕН КАПАК IP20 2M



- AC21PW
- AC21ES
- AC21IW

- конзола IP20 2M
- за външен монтаж на елементи
- в съответствие с EN 60669-1, EN60884-1

- BOX NO CUBO WITH BACK SIDE COVER IP20 2M
- box IP20 2M
- for surface mounting of elements
- in accordance with EN 60669-1, EN60884-1



КОНЗОЛА NO CUBO СЪС ЗАДЕН КАПАК IP20 4M



- AC41PW
- AC41ES
- AC41IW

- конзола IP20 4M
- за външен монтаж на елементи
- в съответствие с EN 60669-1, EN60884-1

- BOX NO CUBO WITH BACK SIDE COVER IP20 4M
- box IP20 4M
- for surface mounting of elements
- in accordance with EN 60669-1, EN60884-1



КОНЗОЛА NO CUBO СЪС ЗАДЕН КАПАК IP20 6M



- AC61PW
- AC61ES
- AC61IW

- конзола IP20 6M
- за външен монтаж на елементи
- в съответствие с EN 60669-1, EN60884-1

- BOX NO CUBO WITH BACK SIDE COVER IP20 6M
- box IP20 6M
- for surface mounting of elements
- in accordance with EN 60669-1, EN60884-1

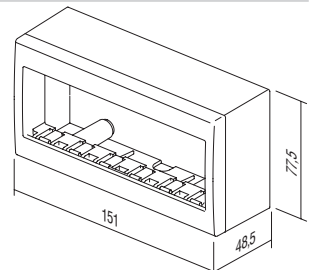
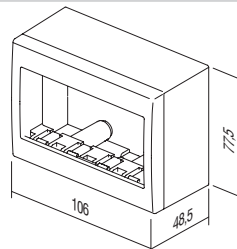
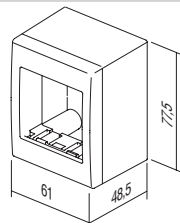
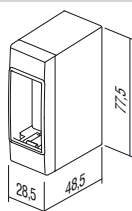

B O X E S C U B O I P 5 5 A Q



тип type	описание description	технически данни technical data	размер size	ЦВЯТ colour
AQ20	КОНЗОЛА NO CUBO OUTDOOR SURFACE MOUNT BOX	IP55	2M	<input type="checkbox"/> PW СНЕЖНОБЯЛ ЦВЯТ polar white
AQ22	КОНЗОЛА NO CUBO OUTDOOR SURFACE MOUNT BOX	IP55	2x2M	<input checked="" type="checkbox"/> GY сив grey
AQ30	КОНЗОЛА NO CUBO OUTDOOR SURFACE MOUNT BOX	IP55	3M	
AQ31	КОНЗОЛА PO CUBO OUTDOOR SURFACE MOUNT BOX	IP55	3M	

КОНЗОЛА NO CUBO IP55 2M



- AQ20PW
 AQ20GY

- конзола IP55 2M
- за външен монтаж
- IP55 за използване във влажни зони
- в съответствие с IEC 23-48, CEI 60670

BOX NO CUBO IP55 2M

- box IP55 2M
- for surface mounting
- IP55 for usage in humid areas
- in accordance with CEI 23-48, EN 60670



КОНЗОЛА NO CUBO IP55 2x2M



- AQ22PW
 AQ22GY

- конзола IP55 2x2M
- за външен монтаж
- IP55 за използване във влажни зони
- в съответствие с IEC 23-48, CEI 60670

BOX NO CUBO IP55 2x2M

- box IP55 2x2M
- for surface mounting
- IP55 for usage in humid areas
- in accordance with CEI 23-48, EN 60670



КОНЗОЛА NO CUBO IP55 3M



- AQ30PW
 AQ30GY

- конзола IP55 3M
- за външен монтаж
- IP55 за използване във влажни зони
- в съответствие с IEC 23-48, CEI 60670

BOX NO CUBO IP55 3M

- box IP55 3M
- for surface mounting
- IP55 for usage in humid areas
- in accordance with CEI 23-48, EN 60670



КУТИЯ РО СУВО IP55 2M



- AQ21PW
- AQ21AT

- кутия IP55 2M
- може да се съчетава с функционални елементи на Modul
- за вграден монтаж
- IP55 за употреба в помещения с наличие на влага
- в съответствие със CEI 23-48, EN 60670

BOX PO СУВО IP55 2M

- box IP55 2M
- can be combined with all Modul functional elements
- for flush mounting
- IP55 for usage in humid areas
- in accordance with CEI 23-48, EN 60670



КОНЗОЛА РО СУВО IP55 3M



- AQ31PW
- AQ31GY

- конзола IP55 3M
- за скрит монтаж
- IP55 за използване във влажни зони
- в съответствие с IEC 23-48, CEI 60670

BOX PO СУВО IP55 3M

- box IP55 3M
- for flush mounting
- IP55 for usage in humid areas
- in accordance with CEI 23-48, EN 60670

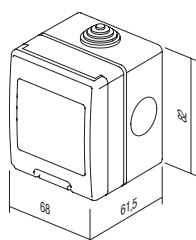

AQ20

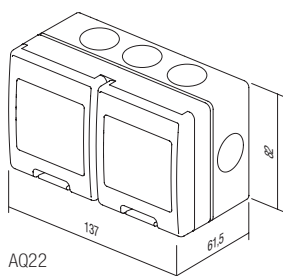

AQ22

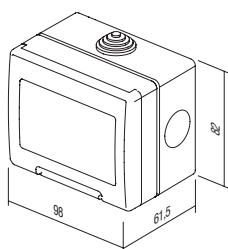

AQ30

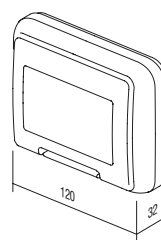

AQ31

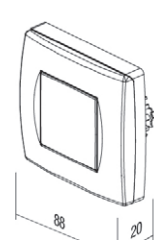

AQ21

TRUNKING SYSTEM ALUMINIUM

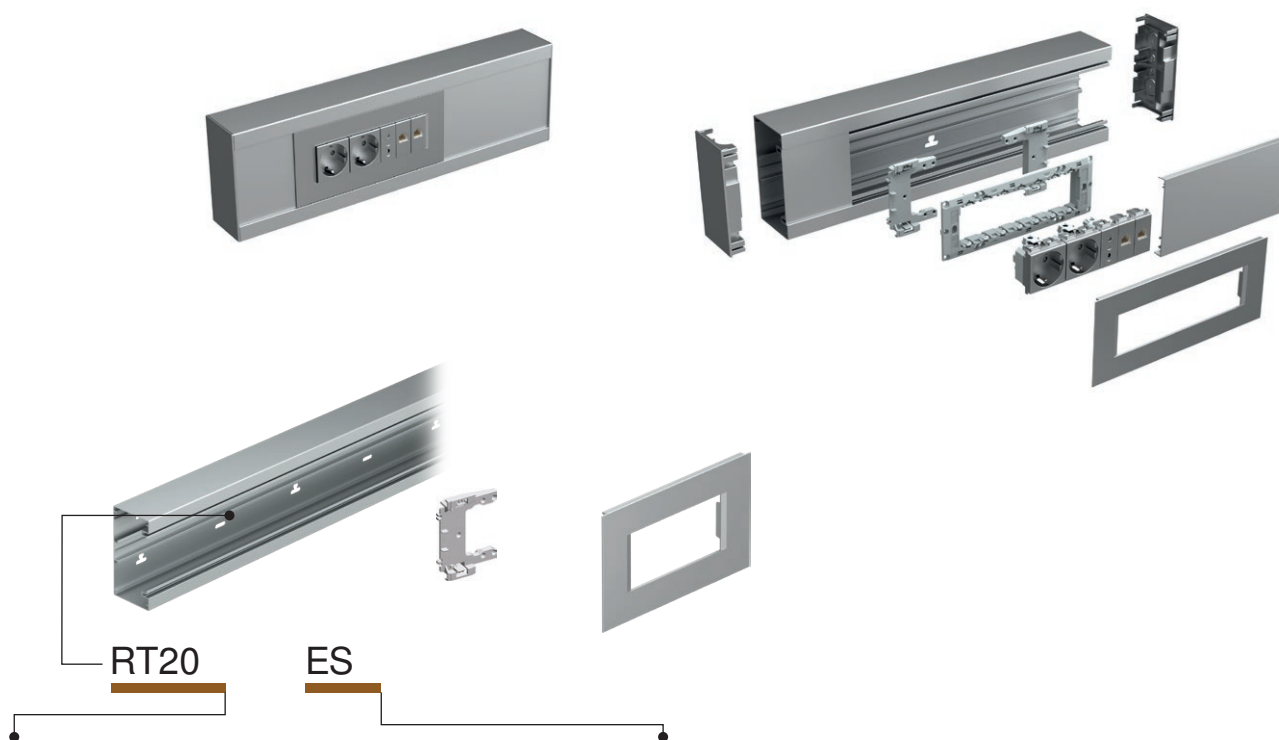

тип type	описание description	размер size	цвет colour
RT10	АДАПТЕР MA 92 ADAPTER MA 92	/	■ ES сребрист цвят с анодизирано покритие elox silver-mat
RT12	ПАНЕЛ MA 92 COVER PLATE MA 92	2/3M	□ PW бял матов (RAL 9016) white-mat
RT14	ПАНЕЛ MA 92 COVER PLATE MA 92	4M	
⋮	⋮	⋮	
⋮	⋮	⋮	

АДАПТЕР MA 92



RT10

- адаптер за закрепване за монтажни рамки 2/3M, 4M или 7M върху канал MA без конзола
- за всяка монтажна рамка са нужни два адаптера
- в съответствие с EN 50085-1

ADAPTER MA 92

- adapter for fixing mounting frames 2/3M, 4M or 7M on MA trunking without box
- each mounting frame needs two adapters
- in accordance with EN 50085-1

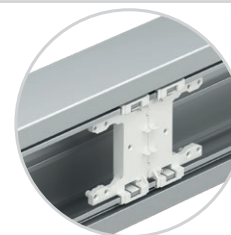

ПАНЕЛ MA 92 2/3M



■ RT12ES
□ RT12PW

- декоративен панел MA 2/3M
- в съответствие с EN 50085-1

COVER PLATE MA 92 2/3M

- decorative cover plate MA 2/3M
- in accordance with EN 50085-1

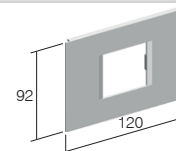

ПАНЕЛ MA 92 4M



■ RT14ES
□ RT14PW

- декоративен панел MA 4M
- в съответствие с EN 50085-1

COVER PLATE MA 92 4M

- decorative cover plate MA 4M
- in accordance with EN 50085-1

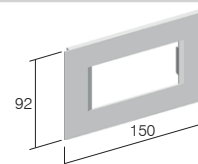

ПАНЕЛ MA 92 7M



■ RT17ES
□ RT17PW

- декоративен панел MA 7M
- в съответствие с EN 50085-1

COVER PLATE MA 92 7M

- decorative cover plate MA 7M
- in accordance with EN 50085-1

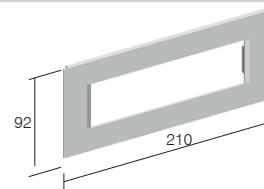

ОСНОВА ЗА КАНАЛ МА 130x65



- RT20ES
- RT20PW

- основа за канал от екструдирани алуминий
- височина 130 mm, дължина 2 m
- DIN – релса 35 mm долен профил
- в съответствие с EN 50085-1

TRUNKING BASE MA 130x65

- *trunking base from extruded aluminium*
- *height 130mm, length 2m*
- *DIN - rail 35mm shape on bottom*
- *in accordance with EN 50085-1*

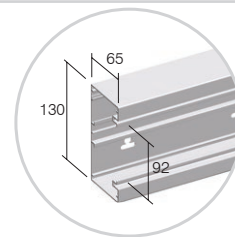

ОСНОВА ЗА КАНАЛ МА 165x65



- RT21ES
- RT21PW

- основа за канал от екструдирани алуминий
- височина 165 mm, дължина 2 m
- DIN – релса 35 mm долен профил
- в съответствие с EN 50085-1

TRUNKING BASE MA 165x65

- *trunking base from extruded aluminium*
- *height 165mm, length 2m*
- *DIN - rail 35mm shape on bottom*
- *in accordance with EN 50085-1*

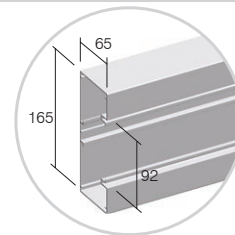

ПРЕДЕН КАПАК МА 92



- RT25ES
- RT25PW

- преден капак от екструдирани алуминий
- височина 92mm, дължина 2 m
- в съответствие с EN 50085-1

FRONT COVER MA 92

- *front cover from extruded aluminium*
- *height 92mm, length 2m*
- *in accordance with EN 50085-1*

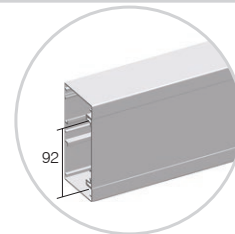

КАБЕЛНА СКАРА МА 43



RT30

- кабелна скара от екструдирани полимер
- дълбочина 43 mm, дължина 2 m
- в съответствие с EN 50085-1

CABLE SHELF MA 43

- *cable shelf from extruded polymer*
- *depth 43mm, length 2m*
- *in accordance with EN 50085-1*

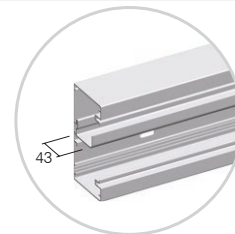

КАБЕЛНА СКАРА МА 43 AL



RT31

- кабелна скара от екструдирани алуминий
- дълбочина 43 mm, дължина 2 m
- в съответствие с EN 50085-1

CABLE SHELF MA 43 AL

- *cable shelf from extruded aluminium*
- *depth 43mm, length 2m*
- *in accordance with EN 50085-1*

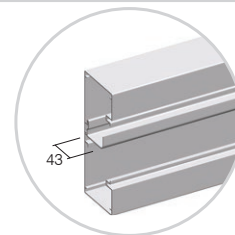

ДВОЙНА КАБЕЛНА СКАРА МА 43 AL



RT32

- двойна кабелна скара от екструдирани алуминий
- дълбочина 43 mm, дължина 2 m
- в съответствие с EN 50085-1

CABLE SHELF MA 43 AL DOUBLE

- *double cable shelf from extruded aluminium*
- *depth 43mm, length 2m*
- *in accordance with EN 50085-1*

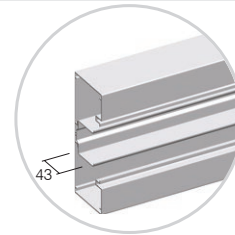

TRUNKING SYSTEM ALUMINIUM

КРАЕН ЕЛЕМЕНТ МА 130x65



- RT35ES
- RT35PW

- краен елемент от полимер
- височина 130 mm
- в съответствие с EN 50085-1

STOP END MA 130x65

- stop end element from polymer
- height 130mm
- in accordance with EN 50085-1

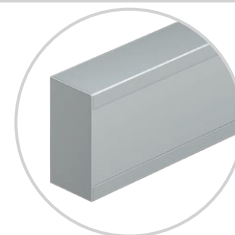

КРАЕН ЕЛЕМЕНТ МА 165x65



- RT36ES
- RT36PW

- метален краен елемент
- височина 165mm
- в съответствие с EN 50085-1

STOP END MA 165x65

- stop end element from metal
- height 165mm
- in accordance with EN 50085-1

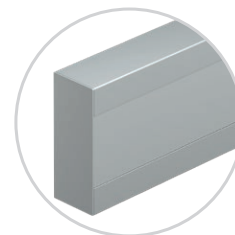

КОМПЛЕКТ СЪЕДИНИТЕЛЕН ЕЛЕМЕНТ МА 65



RT38

- съединителен елемент от полимер
- комплектът съдържа два елемента и винтове
- в съответствие с EN 50085-1

SET JOINING PIECE MA 65

- joining piece from polymer
- set contains two pieces and screws
- in accordance with EN 50085-1

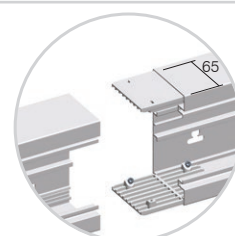

УНИВЕРСАЛЕН ТЪГЛОВ ЕЛЕМЕНТ МА 130x65



- RT40ES
- RT40PW

- универсален ъглов елемент
- височина 130 mm
- в съответствие с EN 50085-1

UNIVERSAL CORNER MA 130x65

- universal corner element
- height 130mm
- in accordance with EN 50085-1



УНИВЕРСАЛЕН ТЪГЛОВ ЕЛЕМЕНТ МА 165x65

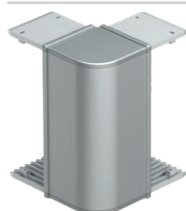

- RT41ES
- RT41PW

- универсален ъглов елемент
- височина 165mm
- в съответствие с EN 50085-1

UNIVERSAL CORNER MA 165x65

- universal corner element
- height 165mm
- in accordance with EN 50085-1



ЗАЗЕМИТЕЛЕН ЕЛЕМЕНТ МА 2 x А6.3



RT42

- заземителен елемент за заземяване на основата на канала и предния капак
- в съответствие с EN 50085-1

EARTHING PIECE MA 2x A6.3

- earthing piece for earthing of trunking base and front cover
- in accordance with EN 50085-1

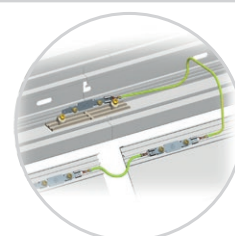

L-КОЛЯНО МА 130x65 / 130



- RT43ES
- RT43PW

- универсален елемент- L-коляно от алуминий
- височина 130 mm, дължина 400 mm
- свързване с МА 130x65
- в съответствие с EN 50085-1

L-BEND MA 130x65 / 130

- universal L bend element from aluminium
- height 130mm, length 400mm
- connection on MA 130x65
- in accordance with EN 50085-1

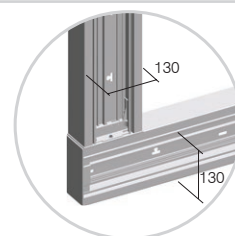

L-КОЛЯНО MA 165x65 / 130



- RT44ES
- RT44PW

- универсален елемент- L-коляно от алуминий
- височина 165 mm, дължина 400 mm
- свързване с MA 130x65
- в съответствие с EN 50085-1

L-BEND MA 165x65 / 130

- universal L bend element from aluminium
- height 165mm, length 400mm
- connection on MA 130x65
- in accordance with EN 50085-1

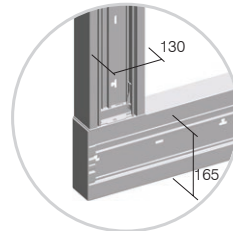

L-КОЛЯНО MA 165x65 / 165



- RT47ES
- RT47PW

- универсален елемент- L-коляно от алуминий
- височина 165 mm, дължина 400 mm
- свързване с MA 165x65
- в съответствие с EN 50085-1

L-BEND MA 165x65 / 165

- universal L bend element from aluminium
- height 165mm, length 400mm
- connection on MA 165x65
- in accordance with EN 50085-1

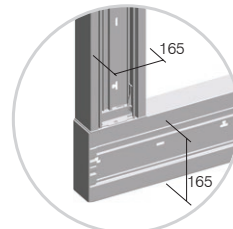

T-КОЛЯНО MA 130x65 / 130



- RT45ES
- RT45PW

- универсален елемент- T-коляно от алуминий
- височина 130 mm, дължина 400 mm
- свързване с MA 130x65
- в съответствие с EN 50085-1

T-BEND MA 130x65 / 130

- universal T bend element from aluminium
- height 130mm, length 400mm
- connection on MA 130x65
- in accordance with EN 50085-1

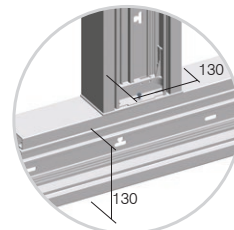

T-КОЛЯНО MA 165x65 / 130

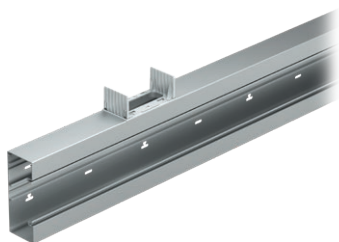

- RT46ES
- RT46PW

- универсален елемент- T-коляно от алуминий
- височина 165 mm, дължина 400 mm
- свързване с MA 130x65
- в съответствие с EN 50085-1

T-BEND MA 165x65 / 130

- universal T bend element from aluminium
- height 165mm, length 400mm
- connection on MA 130x65
- in accordance with EN 50085-1

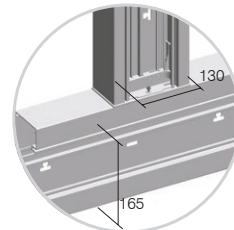

T-КОЛЯНО MA 165x65 / 165

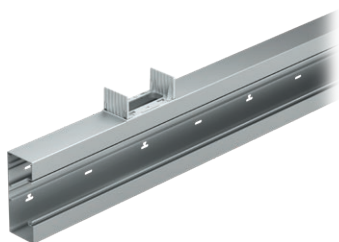

- RT48ES
- RT48PW

- универсален елемент- T-коляно от алуминий
- височина 165 mm, дължина 400 mm
- свързване с MA 165x65
- в съответствие с EN 50085-1

T-BEND MA 165x65 / 165

- universal T bend element from aluminium
- height 165mm, length 400mm
- connection on MA 165x65
- in accordance with EN 50085-1

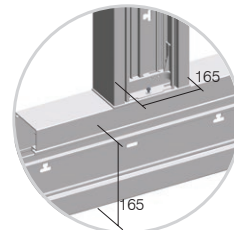

каналите MA се основават на модулна система за 2M, 4M или 7M комбинации от елементи
 MA trunking is based on modular system making 2M, 4M or 7M combinations of elements

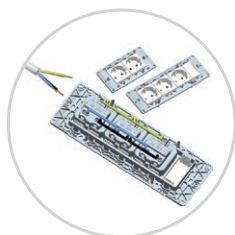

В Modul ние предоставяме специални елементи за бърз монтаж
 In Modul we provide special elements for quick installation

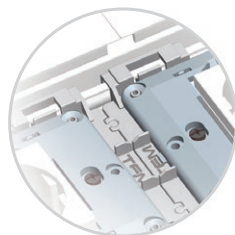

С Adapter MA се предоставя точно позициониране без излишни усилия
 With Adapter MA exact positioning without extra effort is provided

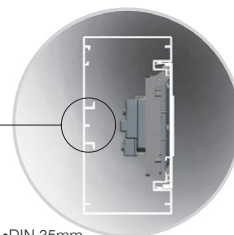

Монтаж без конзола означава повече място за кабели, DIN-релса базов профил EN-60715
 Mounted without box means more space for cables, DIN-rail base shape EN-60715

TRUNKING SYSTEM ALUMINIUM



ЕДИНИЧНА ЗАКРЕПВАЩА ПЛАСТИНА MA 130x65



- RT50ES
- RT50PW

- закрепваща пластина за закрепване на основа за канал MA130 върху под и/или на таван
- в съответствие с EN 50085-1

FIXING PLATE MA SINGLE 130x65

- fixing plate for fixing trunking base MA130 on the floor and/or on the ceiling
- in accordance with EN 50085-1



- RT51ES
- RT51PW

ДВОЙНА ЗАКРЕПВАЩА ПЛАСТИНА MA 130x65

- закрепваща пластина за закрепване на две основи за канал MA130 върху под и/или на таван
- в съответствие с EN 50085-1

FIXING PLATE MA DOUBLE 130x65

- fixing plate for fixing two trunking bases MA130 on the floor and/or on the ceiling
- in accordance with EN 50085-1



СЕРВИЗНА КОЛОНА MA 130x65x500



- RT52ES
- RT52PW

- сервисна колона MA
- височина 500 mm
- включена в доставката монтажна рамка 7M
- в съответствие с EN 50085-1

SERVICE POST MA 130x65x500

- service post MA
- height 500mm
- mounting frame 7M included
- in accordance with EN 50085-1



- RT53ES
- RT53PW

ДВОЙНА СЕРВИЗНА КОЛОНА MA 130x130x500

- двойна сервисна колона MA
- височина 500 mm
- включена в доставката монтажни рамки 7M
- в съответствие с EN 50085-1

SERVICE POST MA DOUBLE 130x130x500

- service post MA double
- height 500mm
- mounting frames 7M included
- in accordance with EN 50085-1

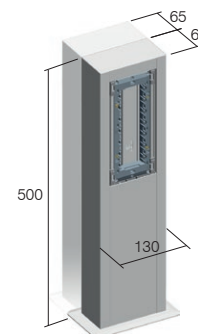

Сечение на кабел / Cable intersection mm ²	Напречно сечение на кабелите / Cable cross-section (mm ²)				
	1 проводник / 1 wire	2 проводника / 2 wires	3 проводника / 3 wires	4 проводника / 4 wires	5 проводника / 5 wires
1,5	44	111	121	144	169
2,5	49	133	157	169	211
4	58	169	183	211	256
6	68	196	225	256	307

Вместимост на канал за кабели / Trunk capacity				
Канал за кабели / Trunk	MA 130x65	MA 130x65	MA 165x65	MA 130x65
	празен / empty	с ключове и контакти Modul / with Modul switches and sockets	празен / empty	с ключове и контакти Modul / with Modul switches and sockets
вместимост / capacity	7600 mm ²	5500 mm ²	9900 mm ²	7800 mm ²
max ø	54 mm	2x42 mm	54 mm	2x42 mm

П О Д О В И К О Н З О Л И М Т

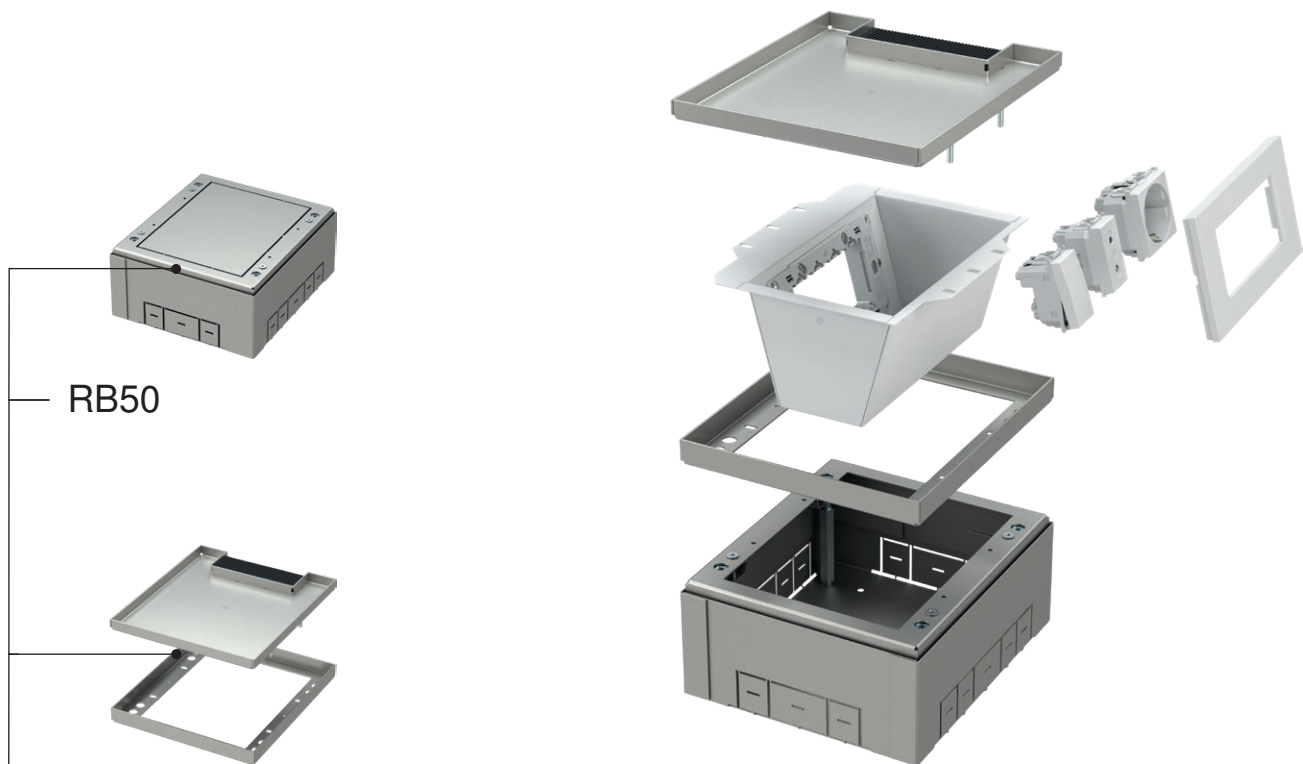

тип type	описание description	технически данни technical data
RB50	ОСНОВА ЗА ПОДОВА КОНЗОЛА FLOOR BOX BASE	4M
RB65S1	КАПАК ЗА ПОДОВА РАЗПРЕДЕЛИТЕЛНА КУТИЯ FLOOR DISTRIBUTION BOX COVER	4M
RB60	ВЛОЖКА ЗА ПОДОВА РАЗПРЕДЕЛИТЕЛНА КУТИЯ INSERT FOR FLOOR DISTRIBUTION BOX	4M
·	·	·
·	·	·

	RB65S1	RB66S1	RB67S2	RB68S2
X	177	178	265	516,5
Y	200,5	265	265	265
Z	17,5	17,5	17,5	17,5

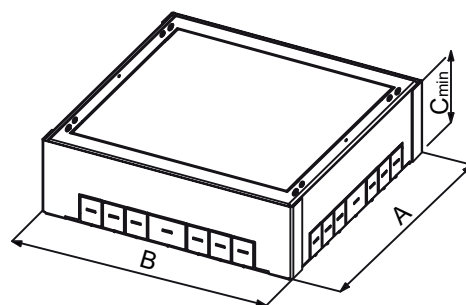
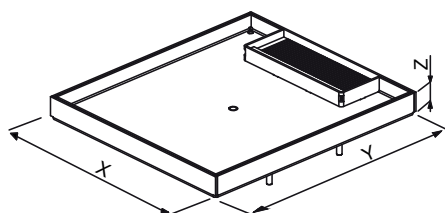

	RB50	RB51	RB52	RB53
A	208,5	273	273	273
B	182	182,5	269,5	521
C	83	83	83	83

F L O O R B O X E S M T

ОСНОВА ЗА ПОДОВА КОНЗОЛА 4М



RB50

- основа за подова конзола 4 М
- метална, с галванично покритие
- за инсталиране в под и в двоен под
- размери за монтаж 208,5 x 182 мм, дълбочина мин. 83 мм
- регулируема височина 83 – 128 мм
- в съответствие с EN 5005-1 в EN 50085-2-2

FLOOR BOX BASE 4M

- floor box base 4M
- metal, galvanized
- for installation in a floor or double floor
- mounting dimensions 208.5x182mm, min. depth 83mm
- adjustable height 83-128mm
- in accordance with EN 5005-1 and EN 50085-2-2

ВЛОЖКА ЗА ПОДОВА РАЗПРЕДЕЛИТЕЛНА КУТИЯ 4 М



RB60

- вложка за подова конзола 4 М
- метална, бял цвят RAL 9006
- включен МОДУЛ за монтажна рамка 4 М
- в съответствие с EN 5005-1 в EN 50085-2-2

INSERT FOR FLOOR DISTRIBUTION BOX 4M

- insert for floor box 4M
- metal, colour white RAL 9006
- mounting frame MODUL 4M included
- in accordance with EN 5005-1 and EN 50085-2-2

КАПАК ЗА ПОДОВА РАЗПРЕДЕЛИТЕЛНА КУТИЯ 4 М



RB65S1

- капак за подова конзола 4 М
- метална, с галванично покритие
- размери за монтаж 200,5 x 177 мм, дълбочина 17,5 мм
- дебелина на пода до 11,5 мм
- в съответствие с EN 5005-1 в EN 50085-2-2

FLOOR DISTRIBUTION BOX COVER 4M

- floor box cover 4M
- metal, galvanized
- mounting dimensions 200.5x177mm, depth 17.5mm
- floor thickness up to 11.5mm
- in accordance with EN 5005-1 and EN 50085-2-2

ОСНОВА ЗА ПОДОВА КОНЗОЛА 7 М



RB51

- основа за подова конзола 7 М
- метална, с галванично покритие
- за инсталиране в под и в двоен под
- размери за монтаж 273 x 182,5 мм, дълбочина мин. 83 мм
- регулируема височина 83 – 128 мм
- в съответствие с EN 5005-1 в EN 50085-2-2

FLOOR BOX BASE 7M

- floor box base 7M
- metal, galvanized
- for installation in a floor or double floor
- mounting dimensions 273x182.5mm, min. depth 83mm
- adjustable height 83-128mm
- in accordance with EN 5005-1 and EN 50085-2-2

ВЛОЖКА ЗА ПОДОВА РАЗПРЕДЕЛИТЕЛНА КУТИЯ 7 М



RB61

- вложка за подова конзола 7 М
- метална, бял цвят RAL 9006
- включен МОДУЛ за монтажна рамка 7 М
- в съответствие с EN 5005-1 в EN 50085-2-2

INSERT FOR FLOOR DISTRIBUTION BOX 7M

- insert for floor box 7M
- metal, colour white RAL 9006
- mounting frame MODUL 7M included
- in accordance with EN 5005-1 and EN 50085-2-2

КАПАК ЗА ПОДОВА РАЗПРЕДЕЛИТЕЛНА КУТИЯ 7 М



RB66S1

- капак за подова конзола 7 М
- метална, с галванично покритие
- размери за монтаж 265 x 178 мм, дълбочина 17,5 мм
- дебелина на пода до 11,5 мм
- в съответствие с EN 5005-1 в EN 50085-2-2

FLOOR DISTRIBUTION BOX COVER 7M

- floor box cover 7M
- metal, galvanized
- mounting dimensions 265x178mm, depth 17.5mm
- floor thickness up to 11.5mm
- in accordance with EN 5005-1 and EN 50085-2-2

ОСНОВА ЗА ПОДОВА КОНЗОЛА 2 X 7 М

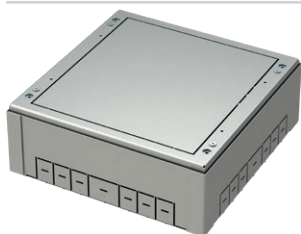

RB52

- основа за подова конзола 2 X 7 М
- метална, с галванично покритие
- за инсталиране в под и в двоен под
- размери за монтаж 273 x 269,5 мм, дълбочина мин. 83 мм
- регулируема височина 83 – 128 мм
- в съответствие с EN 5005-1 в EN 50085-2-2

FLOOR BOX BASE 2X7M

- floor box base 2X7M
- metal, galvanized
- for installation in a floor or double floor
- mounting dimensions 273x269.5mm, min. depth 83mm
- adjustable height 83-128mm
- in accordance with EN 5005-1 and EN 50085-2-2

ВЛОЖКА ЗА ПОДОВА РАЗПРЕДЕЛИТЕЛНА КУТИЯ 2X7 М



RB62

- вложка за подова конзола 2 x 7 М
- метална, бял цвят RAL 9006
- включен МОДУЛ за монтажни рамки 2x7M
- в съответствие с EN 5005-1 в EN 50085-2-2

INSERT FOR FLOOR DISTRIBUTION BOX 2X7M

- insert for floor box 2x7M
- metal, colour white RAL 9006
- mounting frames MODUL 2x7M included
- in accordance with EN 5005-1 and EN 50085-2-2

КАПАК ЗА ПОДОВА РАЗПРЕДЕЛИТЕЛНА КУТИЯ 2 X 7 М

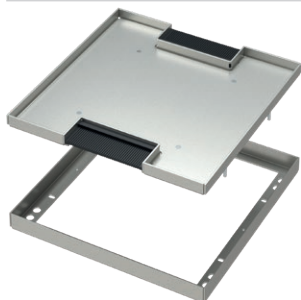

RB67S2

- капак за подова конзола 2x7 М
- метална, с галванично покритие
- размери за монтаж 265 x 265 мм, дълбочина 17,5 мм
- дебелина на пода до 11,5 мм
- в съответствие с EN 5005-1 в EN 50085-2-2

FLOOR DISTRIBUTION BOX COVER 2X7M

- floor box cover 2x7M
- metal, galvanized
- mounting dimensions 265x265mm, depth 17.5mm
- floor thickness up to 11.5mm
- in accordance with EN 5005-1 and EN 50085-2-2

ОСНОВА ЗА ПОДОВА КОНЗОЛА 4 X 7 М

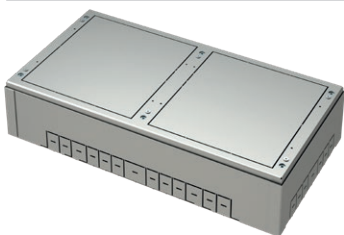

RB53

- основа за подова конзола 4 X 7 М
- метална, с галванично покритие
- за инсталиране в под и в двоен под
- размери за монтаж 273 x 521 мм, дълбочина мин. 83 мм
- регулируема височина 83 – 128 мм
- в съответствие с EN 5005-1 в EN 50085-2-2

FLOOR BOX BASE 4X7M

- floor box base 4X7M
- metal, galvanized
- for installation in a floor or double floor
- mounting dimensions 273x521mm, min. depth 83mm
- adjustable height 83-128mm
- in accordance with EN 5005-1 and EN 50085-2-2

ВЛОЖКА ЗА ПОДОВА РАЗПРЕДЕЛИТЕЛНА КУТИЯ 2X7 М



RB62

- вложка за подова конзола 2 x 7 М
- метална, бял цвят RAL 9006
- включен МОДУЛ за монтажни рамки 2x7M
- в съответствие с EN 5005-1 в EN 50085-2-2

INSERT FOR FLOOR DISTRIBUTION BOX 2X7M

- insert for floor box 2x7M
- metal, colour white RAL 9006
- mounting frames MODUL 2x7M included
- in accordance with EN 5005-1 and EN 50085-2-2

КАПАК ЗА ПОДОВА РАЗПРЕДЕЛИТЕЛНА КУТИЯ 4 X 7 М



RB68S2

- капак за подова конзола 4 x 7 М
- метална, с галванично покритие
- размери за монтаж 265 x 516,5 мм, дълбочина 17,5 мм
- дебелина на пода до 11,5 мм
- в съответствие с EN 5005-1 в EN 50085-2-2

FLOOR DISTRIBUTION BOX COVER 4X7M

- floor box cover 4x7M
- metal, galvanized
- mounting dimensions 265x516.5mm, depth 17.5mm
- floor thickness up to 11.5mm
- in accordance with EN 5005-1 and EN 50085-2-2



RB55S1

тип type	описание description	технически данни technical data
RB55S1	ПОДОВА КОНЗОЛА С КАПАК ЗА ДВОЕН ПОД FLOOR BOX WITH COVER FOR DOUBLE FLOORS	4M
RB60	ВЛОЖКА ЗА ПОДОВА РАЗПРЕДЕЛИТЕЛНА КУТИЯ INSERT FOR FLOOR DISTRIBUTION BOX	4M
⋮	⋮	⋮
⋮	⋮	⋮

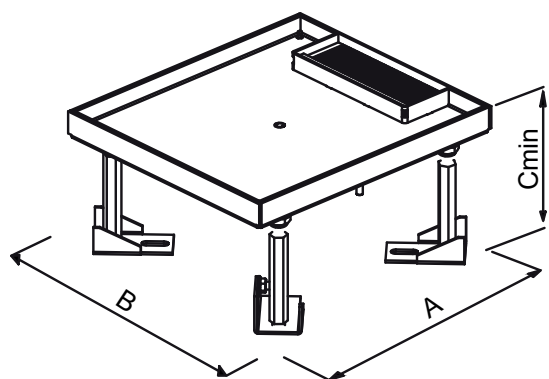

	RB55S1	RB56S1	RB57S2	RB58S2
A	200,5	265	265	265
B	177	178	265	516,5
C	100	100	100	100

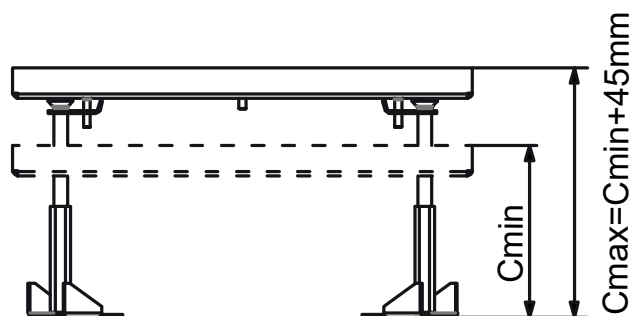

ПОДОВА КОНЗОЛА С КАПАК ЗА ДВОЕН ПОД 4 М



RB55S1

- основа за подова конзола 4 М
- метална, с галванично покритие
- размери за монтаж 200,5 x 177 мм, дълбочина мин. 100 мм
- регулируема височина 100 – 145 мм
- дебелина на пода до 11,5 мм
- в съответствие с EN 5005-1 в EN 50085-2-2

FLOOR BOX WITH COVER FOR DOUBLE FLOORS 4M

- floor box base 4M
- metal, galvanized
- mounting dimensions 200.5x177mm, min. depth 100mm
- adjustable height 100-145mm
- floor thickness up to 11.5mm
- in accordance with EN 5005-1 and EN 50085-2-2

ВЛОЖКА ЗА ПОДОВА РАЗПРЕДЕЛИТЕЛНА КУТИЯ 4 М



RB60

- вложка за подова конзола 4 М
- метална, бял цвят RAL 9006
- включен МОДУЛ за монтажна рамка 4 М
- в съответствие с EN 5005-1 в EN 50085-2-2

INSERT FOR FLOOR DISTRIBUTION BOX 4M

- insert for floor box 4M
- metal, colour white RAL 9006
- mounting frame MODUL 4M included
- in accordance with EN 5005-1 and EN 50085-2-2

ПОДОВА КОНЗОЛА С КАПАК ЗА ДВОЕН ПОД 7 М



RB56S1

- основа за подова конзола 7 М
- метална, с галванично покритие
- размери за монтаж 265 x 178 мм, дълбочина мин. 100 мм
- регулируема височина 100 – 145 мм
- дебелина на пода до 11,5 мм
- в съответствие с EN 5005-1 в EN 50085-2-2

FLOOR BOX WITH COVER FOR DOUBLE FLOORS 7M

- floor box base 7M
- metal, galvanized
- mounting dimensions 265x178mm, min. depth 100mm
- adjustable height 100-145mm
- floor thickness up to 11.5mm
- in accordance with EN 5005-1 and EN 50085-2-2

ВЛОЖКА ЗА ПОДОВА РАЗПРЕДЕЛИТЕЛНА КУТИЯ 7 М



RB61

- вложка за подова конзола 7 М
- метална, бял цвят RAL 9006
- включен МОДУЛ за монтажна рамка 7 М
- в съответствие с EN 5005-1 в EN 50085-2-2

INSERT FOR FLOOR DISTRIBUTION BOX 7M

- insert for floor box 7M
- metal, colour white RAL 9006
- mounting frame MODUL 7M included
- in accordance with EN 5005-1 and EN 50085-2-2

ПОДОВА КОНЗОЛА С КАПАК ЗА ДВОЕН ПОД 2 X 7 М



RB57S2

- основа за подова конзола 2 X 7 М
- метална, с галванично покритие
- размери за монтаж 265 x 265 мм, дълбочина мин. 100 мм
- регулируема височина 100 – 145 мм
- дебелина на пода до 11,5 мм
- в съответствие с EN 5005-1 в EN 50085-2-2

FLOOR BOX WITH COVER FOR DOUBLE FLOORS 2X7M

- floor box base 2x7M
- metal, galvanized
- mounting dimensions 265x265mm, min. depth 100mm
- adjustable height 100-145mm
- floor thickness up to 11.5mm
- in accordance with EN 5005-1 and EN 50085-2-2

ВЛОЖКА ЗА ПОДОВА РАЗПРЕДЕЛИТЕЛНА КУТИЯ 2X7 М



RB62

- вложка за подова конзола 2 x 7 М
- метална, бял цвят RAL 9006
- включен МОДУЛ за монтажни рамки 2x7M
- в съответствие с EN 5005-1 в EN 50085-2-2

INSERT FOR FLOOR DISTRIBUTION BOX 2X7M

- insert for floor box 2x7M
- metal, colour white RAL 9006
- mounting frames MODUL 2x7M included
- in accordance with EN 5005-1 and EN 50085-2-2

ПОДОВА КОНЗОЛА С КАПАК ЗА ДВОЕН ПОД 4 X 7 М



RB58S2

- основа за подова конзола 4 X 7 М
- метална, с галванично покритие
- размери за монтаж 265 x 516,5 мм, дълбочина мин. 100 мм
- регулируема височина 100 – 145 мм
- дебелина на пода до 11,5 мм
- в съответствие с EN 5005-1 в EN 50085-2-2

FLOOR BOX WITH COVER FOR DOUBLE FLOORS 4X7M

- floor box base 4x7M
- metal, galvanized
- mounting dimensions 265x516.5mm, min. depth 100mm
- adjustable height 100-145mm
- floor thickness up to 11.5mm
- in accordance with EN 5005-1 and EN 50085-2-2

ВЛОЖКА ЗА ПОДОВА РАЗПРЕДЕЛИТЕЛНА КУТИЯ 2X7 М



RB62

- вложка за подова конзола 2 x 7 М
- метална, бял цвят RAL 9006
- включен МОДУЛ за монтажни рамки 2x7M
- в съответствие с EN 5005-1 в EN 50085-2-2

INSERT FOR FLOOR DISTRIBUTION BOX 2X7M

- insert for floor box 2x7M
- metal, colour white RAL 9006
- mounting frames MODUL 2x7M included
- in accordance with EN 5005-1 and EN 50085-2-2

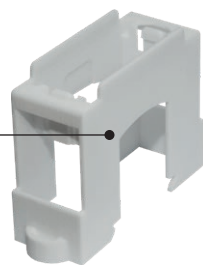
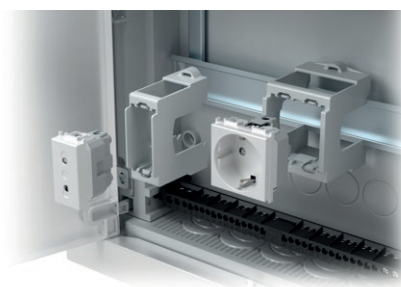
RB10

тип type	описание description	технически данни technical data
RB10	АДАПТЕР ЗА DIN РЕЛСА ADAPTER FOR DIN RAIL	35mm 1M
RB11	АДАПТЕР ЗА DIN РЕЛСА ADAPTER FOR DIN RAIL	35mm 2M
·	РАЗПРЕДЕЛИТЕЛНА КУТИЯ	·
·	·	·
·	·	·

АДАПТЕР ЗА DIN РЕЛСА 35 mm 1M

RB10

- адаптер MODUL 1M
- за DIN релса 35 mm
- в съответствие с EN 50022

ADAPTER FOR DIN RAIL 35mm 1M

- adapter MODUL 1M
- for DIN rail 35mm
- in accordance with EN 50022

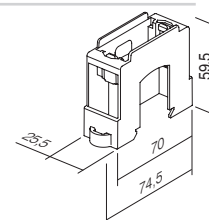

АДАПТЕР ЗА DIN РЕЛСА 35 mm 2M

RB11

- адаптер MODUL 2M
- за DIN релса 35 mm
- в съответствие с EN 50022

ADAPTER FOR DIN RAIL 35mm 2M

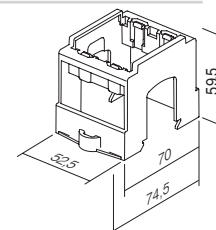
- adapter MODUL 2M
- for DIN rail 35mm
- in accordance with EN 50022



SWITCH
LOGIQ



TEM

LOGIQ

ПЪЛНА УВЕРЕНОСТ създадено за всяка стая

Форма за всяка стая. Ключовете имат универсални линии, които привличат вниманието, както в модерни работни среди, така и в уютни, комфортни жилищни пространства. Семейството LOGIQ предлага просто и логично решение за всяко ваше желание.

OMNIPRESENT CONFIDENCE made for every room

A shape for every room. The switches have universal lines that leave a mark in both modern work environments as well as in cosy, comfortable living spaces. The LOGIQ family offers a simple and logical solution for your every wish.



LOGIQ

ХАРМОНИЯ НА ЦВЕТОВЕТЕ Изберете своя нюанс

Семейството LOGIQ се гордее с логичната си гама от утвърдени и елегантни нюанси, познати и обичани от нашите клиенти. Не правете компромиси, семейството LOGIQ предлага това, което искате. Винаги можем да създадем цветния нюанс според вашата специална заявка. Логично.

HARMONY OF COLOURS Choose your hue

The LOGIQ family prides itself on its logical range of verified and elegant hues known and loved by our clients. Don't compromise, the LOGIQ family has you covered. We can always create the hue of colour in accordance with your special request. Logically.

- антрацит *anthracite*
- титан *titanium*
- полярно бяло *polar white*

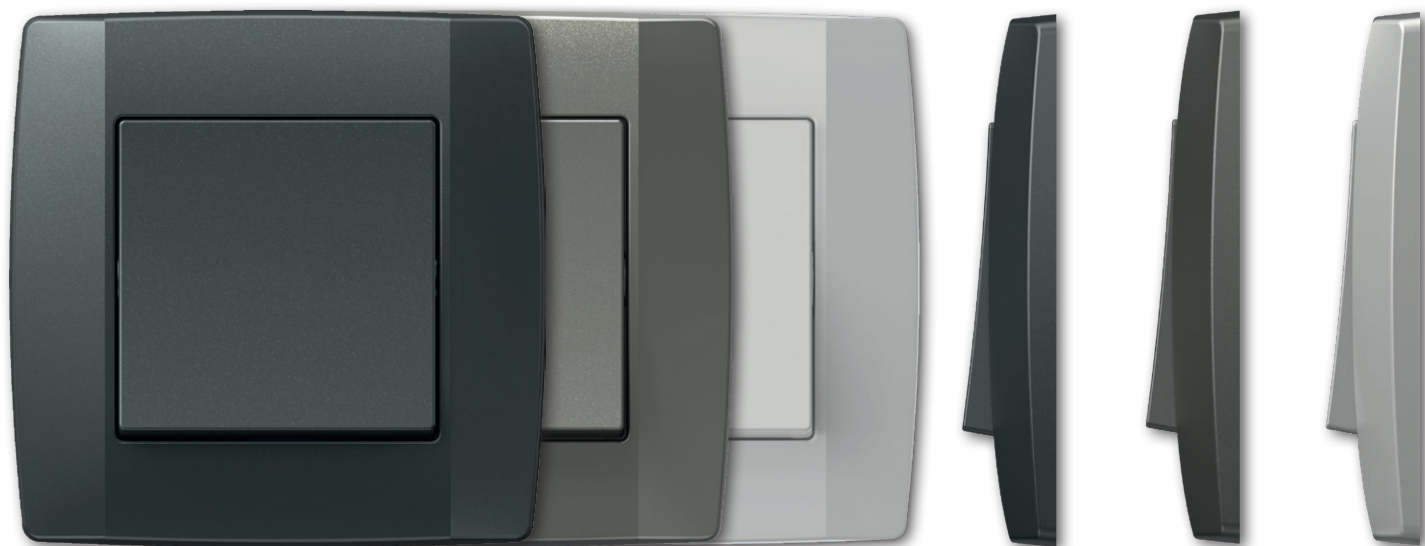

НЕОГРАНИЧЕНО ВЪОБРАЖЕНИЕ Създайте своя собствена комбинация

Семейството LOGIQ ви дава възможност да създадете своя собствена комбинация. За да опростим комбинирането, създадохме полезна система, която поддържа последователното свързване на хоризонтални и вертикални линии. Така наречената система 55/55 ви дава възможност да използвате едни и същи универсални елементи всеки път. Знаете какво искате? Не се тревожете, ключовете LOGIQ могат да четат мислите ви.

LIMITLESS IMAGINATION Create your own combination

The LOGIQ family allows you to create your own combination. To make combining simple, we have created a useful system that supports the sequencing of horizontal and vertical lines. The so-called 55/55 system allows you to use the same universal elements every time. Know what you want? Don't worry, the LOGIQ switches can read your mind.



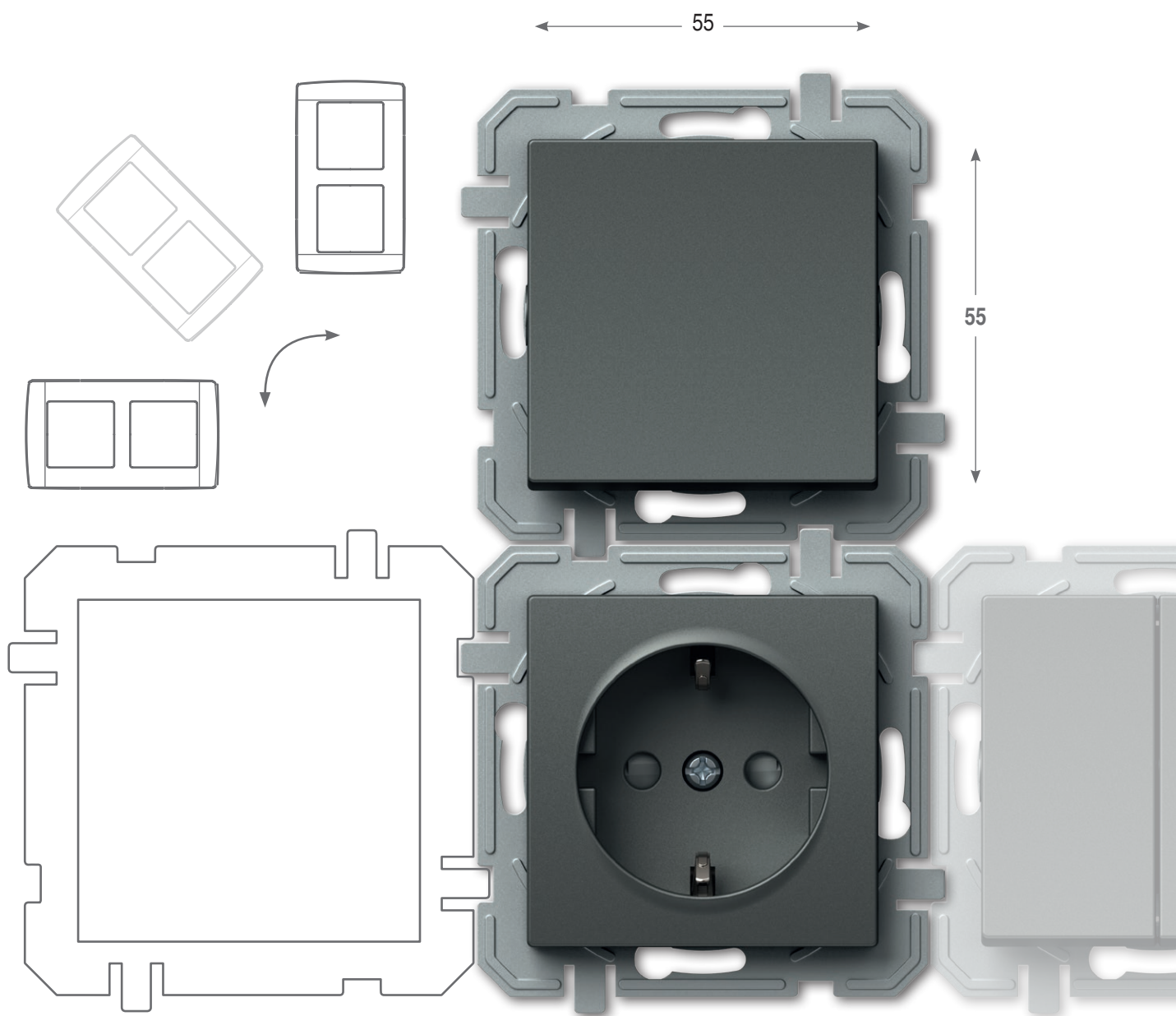

ОПТОСТЕНО ЗА НАЙ-ВЗИСКАТЕЛНИТЕ

Семейството LOGIQ предлага ключове, регулатори, датчици и контакти за всяка цел на едно място. Можете да използвате тези продукти поотделно или в последователна верига. Като всяко семейство, което се разраства и развива, семейството LOGIQ ще продължи да развива гамата си от продукти според вашите нужди и желания. С радост се вслушваме във вас и предлагаме решение, което ще продължи просто и логично историята на семейството LOGIQ.

SIMPLE FOR THE MOST DEMANDING

The LOGIQ family offers switches, regulators, sensors, and sockets for every purpose in one place. You can use these products individually or in a sequence. Just like every family that grows and develops, the LOGIQ family will continue to develop our range of products in accordance with your needs and wishes. We are happy to listen to you and offer a solution which will simply and logically continue the story of the LOGIQ family.



ВСИЧКО НА ЕДНО МЯСТО И ОЩЕ

ALL IN ONE PLACE AND MORE

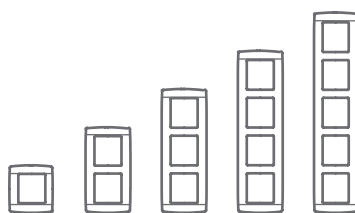

ЛОГИЧЕН МОНТАЖ

LOGIQ е решение за системата от стандартизирани кръгли инсталационни кутии. Може да се използва както за прости, така и за по-взискателни инсталации, нови сгради и приспособления. Системата се характеризира с контакти чрез вкарване, които спестяват време при монтажа на елементите.

LOGICAL INSTALLATION

LOGIQ is a solution for the system of standardized round installations boxes. It can be used for simple as well as more demanding installations, new buildings and adaptations. The system is characterised by plug-in contacts which save time during installation of elements.

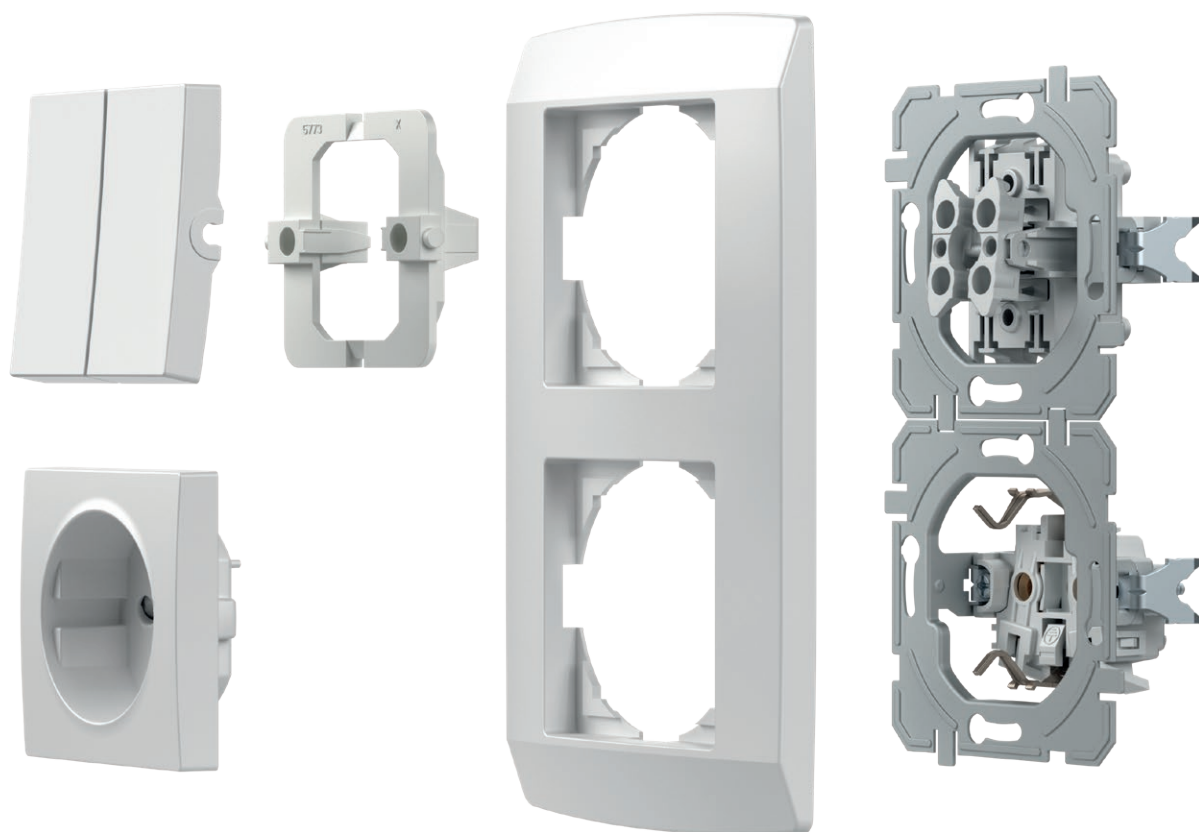

ДОБРЕ Е ДА ЗНАЕТЕ

GOOD TO KNOW



Всички контакти са оборудвани за безопасно изключване, което гарантира защитата на контактите, които са под напрежение.

All the sockets are equipped with a safety shutters assuring the protection to live contacts.



Добре обмислената конструкция на ключа позволява и допълнително лесна индикация.

The well-thought-out design of the switch enables the easy integration of the indication, including at a later time.



Надеждността на превключването се гарантира от контакти от сребърна сплав.

Contacts made of silver alloy guarantee safe switching.

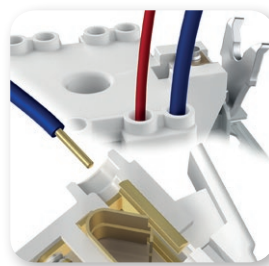

Контактите, осъществявани чрез вкарване на проводниците, позволяват бързо и надеждно закрепване на проводниците. Два проводника с различни диаметри може да се свържат към един и същи контакт.

Plug-in contacts enable quick and reliable attachment of wires. Two wires of different diameters can be attached to the same contact.



Закрепващите крачета дават възможност за по-дълбоко закрепване (също така и през керамични плочки и подобни)

Fixing claws enable deeper fixing (also through ceramic tiles, etc.)



Лесните за монтиране инсталационни конзоли ще улеснят работата ви. Правилните дължини са гарантирани.

Easy-fitting installation boxes will make your work easier. Proper lengths are guaranteed.

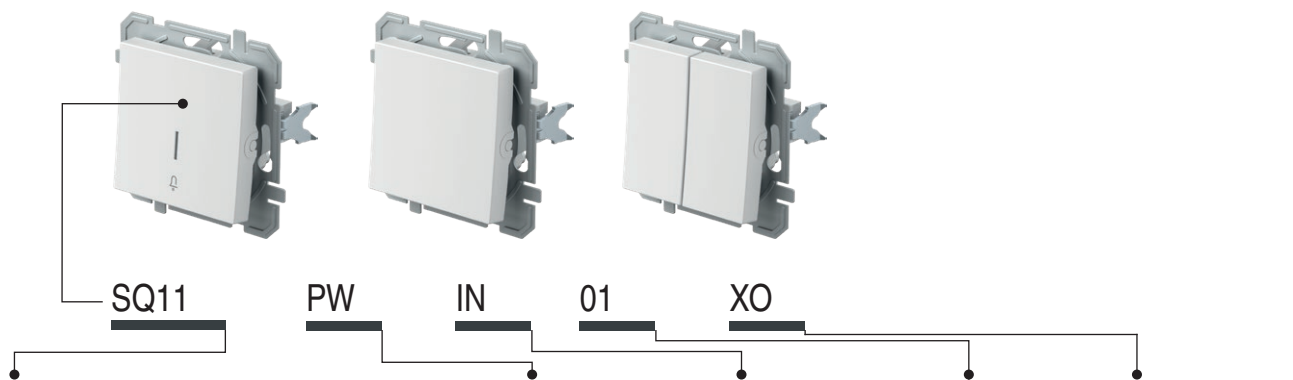

тип type	описание description	технически данни technical data	цвет colour	допълнителна информация 1 optional data 1	допълнителна информация 2 optional data 2	допълнителна информация 3 optional data 3
SQ10	КЛЮЧ 1WAY SWITCH 1WAY	10AX 250V~	<input type="checkbox"/> PW полярно бяло polar white	NT неутрален neutral	01	XO без декоративен панел without cover plate
SQ11	БУТОН 1WAY PUSH BUTTON 1WAY	10A 250V~	<input type="checkbox"/> TI титан titanium	IN индикатор indicator	02	
SQ22	КЛЮЧ 2POLE SWITCH 2POLE	16AX 250V~	<input type="checkbox"/> AT антрацит anthracite	03		
...

КЛЮЧ 1WAY 10AX 250V~



- SQ10PWXO
- SQ10TIXO
- SQ10ATXO



- 10AX 250V~, тип SQ10
 - в съответствие с EN 60669-1
 - контакти чрез вкарване 1,5-2,5 mm²
 SWITCH 1WAY 10AX 250V~
 - 10AX 250V~, type SQ10
 - in accordance with EN 60669-1
 - plug-in contacts 1.5-2.5mm²



КЛЮЧ 1WAY 10AX 250V~ __ IN

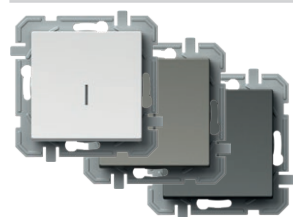

- SQ10PWINXO
- SQ10TIINXO
- SQ10ATINXO



- IN индикатор, без неонна лампа
 - 10AX 250V~, тип SQ10
 - в съответствие с EN 60669-1
 - контакти чрез вкарване 1,5-2,5 mm²
 SWITCH 1WAY 10AX 250V~ __ IN
 - IN indicator, without neon lamp
 - 10AX 250V~, type SQ10
 - in accordance with EN 60669-1
 - plug-in contacts 1.5-2.5mm²



БУТОН 1WAY 10A 250V~

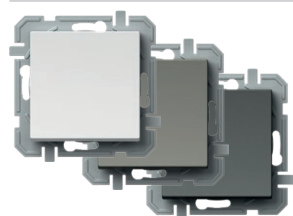

- SQ11PWXO
- SQ11TIXO
- SQ11ATXO



- 10A 250V~, тип SQ11
 - в съответствие с EN 60669-1
 - контакти чрез вкарване 1,5-2,5 mm²
 PUSH BUTTON 1WAY 10A 250V~
 - 10A 250V~, type SQ11
 - in accordance with EN 60669-1
 - plug-in contacts 1.5-2.5mm²



БУТОН 1WAY 10A 250V~ __ IN 01



- SQ11PWIN01XO
- SQ11TIIN01XO
- SQ11ATIN01XO

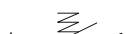

- IN 01 звънчев индикатор, без неонна лампа
 - 10A 250V~, тип SQ11
 - в съответствие с EN 60669-1
 - контакти чрез вкарване 1,5-2,5 mm²
 PUSH BUTTON 1WAY 10A 250V~ __ IN 01
 - IN 01 indicator bell, without neon lamp
 - 10A 250V~, type SQ11
 - in accordance with EN 60669-1
 - plug-in contacts 1.5-2.5mm²





- SQ11PWIN02XO
- SQ11TIIN02XO
- SQ11ATIN02XO



БУТОН 1WAY 10A 250V~ __ IN 02

- IN 02 светлинен индикатор, без неонева лампа
- 10A 250V~, тип SQ11
- в съответствие с EN 60669-1
- контакти чрез вкарване 1,5-2,5 mm²

PUSH BUTTON 1WAY 10A 250V~ __ IN 02

- IN 02 indicator light, without neon lamp
- 10A 250V~, type SQ11
- in accordance with EN 60669-1
- plug-in contacts 1.5-2.5mm²

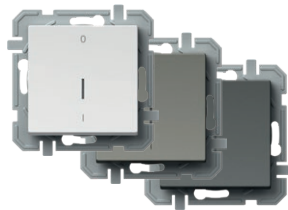

- SQ22PWIN03XO
- SQ22TIIN03XO
- SQ22ATIN03XO

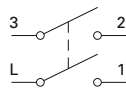

КЛЮЧ 2POLE 16AX 250V~ __ IN 03

- IN 03 неутрален 0-1, без неонева лампа
- 16AX 250V~, тип SQ22
- в съответствие с EN 60669-1
- винтови контакти 1,5-2,5 mm²

SWITCH 2POLE 16AX 250V~ __ IN 03

- IN 03 neutral 0-1, without neon lamp
- 16AX 250V~, type SQ22
- in accordance with EN 60669-1
- screw contacts 1.5-2.5mm²

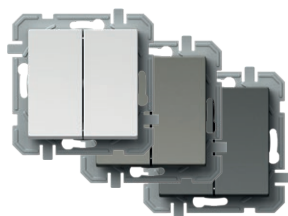

- SQ50PWXO
- SQ50TIXO
- SQ50ATXO

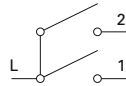

КЛЮЧ 2GANG-1WAY 10AX 250V~

- 10AX 250V~, тип SQ50
- в съответствие с EN 60669-1
- контакти чрез вкарване 1,5-2,5 mm²

SWITCH 2GANG-1WAY 10AX 250V~

- 10AX 250V~, type SQ50
- in accordance with EN 60669-1
- plug-in contacts 1.5-2.5mm²



- SQ51PWXO
- SQ51TIXO
- SQ51ATXO

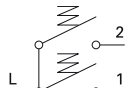

БУТОН 2GANG-1WAY 10A 250V~

- 10A 250V~, тип SQ51
- в съответствие с EN 60669-1
- контакти чрез вкарване 1,5-2,5 mm²

PUSH BUTTON 2GANG-1WAY 10A 250V~

- 10A 250V~, type SQ51
- in accordance with EN 60669-1
- plug-in contacts 1.5-2.5mm²

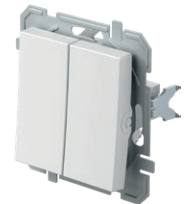

- SQ52PWNT09XO
- SQ52TINT09XO
- SQ52ATNT09XO

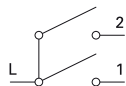

КЛЮЧ ЗА ЩОРИ 10AX 250V~ __ NT 09

- NT 09 неутрално положение – нагоре-надолу
- 10AX 250V~, тип SQ52
- в съответствие с EN 60669-1
- контакти чрез вкарване 1,5-2,5 mm²
- с механична блокировка

SWITCH SHUTTERS 10AX 250V~ __ NT 09

- NT 09 neutral up-down
- 10AX 250V~, type SQ52
- in accordance with EN 60669-1
- plug-in contacts 1.5-2.5mm²
- with mechanical interblock



- SQ53PWNT09XO
- SQ53TINT09XO
- SQ53ATNT09XO

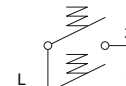

БУТОН ЗА ЩОРИ 10A 250V~ __ NT 09

- NT 09 неутрално положение – нагоре-надолу
- 10A 250V~, тип SQ53
- в съответствие с EN 60669-1
- контакти чрез вкарване 1,5-2,5 mm²
- с механична блокировка

PUSH BUTTON SHUTTERS 10A 250V~ __ NT 09

- NT 09 neutral up-down
- 10A 250V~, type SQ53
- in accordance with EN 60669-1
- plug-in contacts 1.5-2.5mm²
- with mechanical interblock

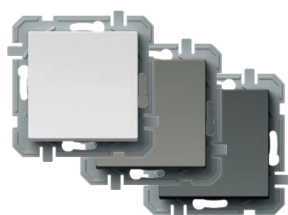

- SQ60PWXO
- SQ60TIXO
- SQ60ATXO

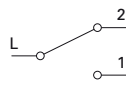

КЛЮЧ 2WAY 10AX 250V~

- 10AX 250V~, тип SQ60
- в съответствие с EN 60669-1
- контакти чрез вкарване 1,5-2,5 mm²

SWITCH 2WAY 10AX 250V~

- 10AX 250V~, type SQ60
- in accordance with EN 60669-1
- plug-in contacts 1.5-2.5mm²



ДВОЕН КЛЮЧ 2WAY 10AX 250V~



- SQ63PWXO
- SQ63TIXO
- SQ63ATXO



- 10AX 250V~, тип SQ63
 - в съответствие с EN 60669-1
 - контакти чрез вкарване 1,5-2,5 mm²
SWITCH DOUBLE 2WAY 10AX 250V~
 - 10AX 250V~, type SQ63
 - in accordance with EN 60669-1
 - plug-in contacts 1.5-2.5mm²



КРЪСТАТ КЛЮЧ 10AX 250V~

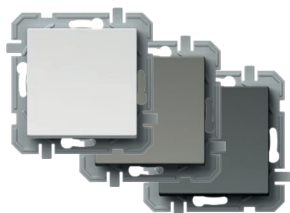

- SQ70PWXO
- SQ70TIXO
- SQ70ATXO



- 10AX 250V~, тип SQ70
 - в съответствие с EN 60669-1
 - контакти чрез вкарване 1,5-2,5 mm²
SWITCH INTERMEDIATE 10AX 250V~
 - 10AX 250V~, type SQ70
 - in accordance with EN 60669-1
 - plug-in contacts 1.5-2.5mm²



SQ10
SQ11

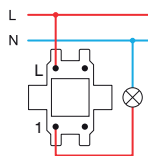

SQ22

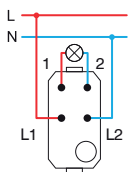

SQ50
SQ51

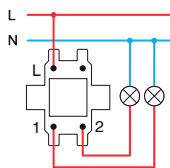

SQ52
SQ53

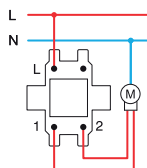

SQ60+SQ60

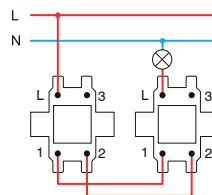

SQ63+SQ63

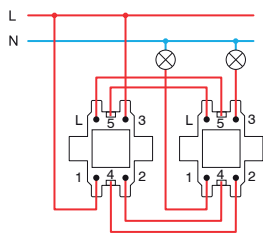

SQ60+SQ70+SQ60

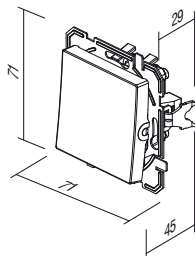
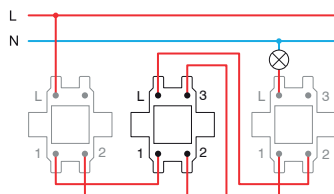

S I G N A L I Z A T I O N I A

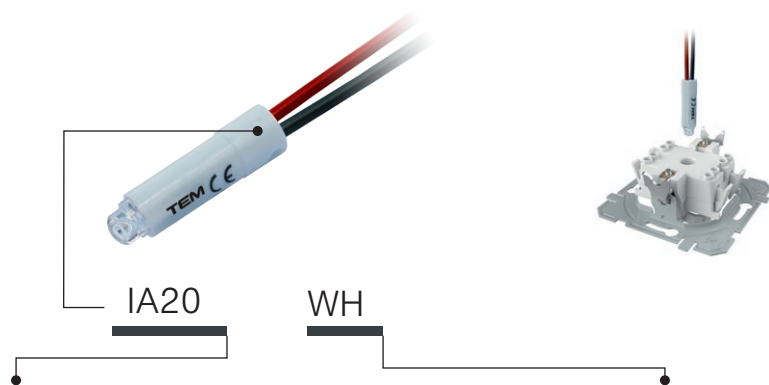

тип type	описание description	технически данни technical data	ЦВЯТ colour
IA10	НЕОНОВА ЛАМПА NEON LAMP	230V~ 0,34W	<input type="checkbox"/> WH бяло white
IA20	СВЕТОДИОДНА СИГНАЛИЗАЦИЯ LED SIGNALLING UNIT	230V~ 0,40W	<input checked="" type="checkbox"/> BL синьо blue
IA21	СВЕТОДИОДНА СИГНАЛИЗАЦИЯ LED SIGNALLING UNIT	24V AC/DC 0,20W	<input checked="" type="checkbox"/> RD червено red
.	.	.	<input checked="" type="checkbox"/> GR зелено green
.	.	.	<input checked="" type="checkbox"/> OR оранжево orange

НЕОНОВА ЛАМПА 230V~ 0,34W

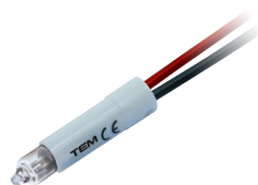
 IA10OR

- за индикиране, сигнализация
или постоянна сигнализация;
- в съчетание с бутон с индикатор

NEON LAMP 230V~ 0,34W

- for indication, signalling
or permanent signalling
- in combination with a button featuring an indicator

СВЕТОДИОДНА СИГНАЛИЗАЦИЯ 230V AC/DC 0,40W



 IA20WH
 IA20GR
 IA20RD
 IA20BL

- за индикиране, сигнализация
или постоянна сигнализация;
- в съчетание с бутон с индикатор

LED SIGNALLING UNIT 230V AC/DC 0,40W

- for indication, signalling
or permanent signalling
- in combination with a button featuring an indicator

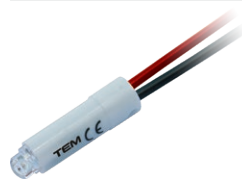
СВЕТОДИОДНА СИГНАЛИЗАЦИЯ 24V AC/DC 0,20W

 IA21WH
 IA21RD

- за индикиране, сигнализация
или постоянна сигнализация;
- в съчетание с бутон с индикатор

LED SIGNALLING UNIT 24V AC/DC 0,20W

- for indication, signalling
or permanent signalling
- in combination with a button featuring an indicator

СВЕТОДИОДНА СИГНАЛИЗАЦИЯ 12V AC/DC 0,10W

 IA22WH
 IA22RD

- за индикиране, сигнализация
или постоянна сигнализация;
- в съчетание с бутон с индикатор

LED SIGNALLING UNIT 12V AC/DC 0,10W

- for indication, signalling
or permanent signalling
- in combination with a button featuring an indicator

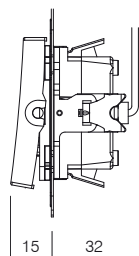

15 | 32

Индикация
Indication

*Сигнализация
Signalization

Постоянна сигнализация
Permanent signalling

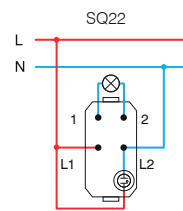
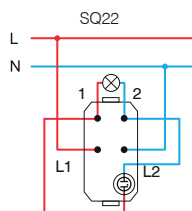
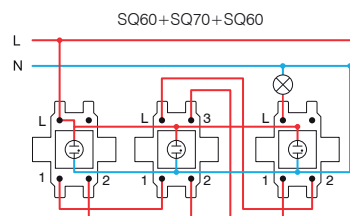
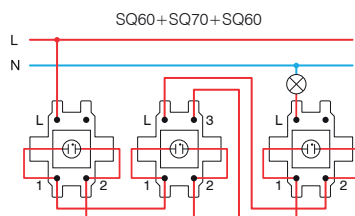
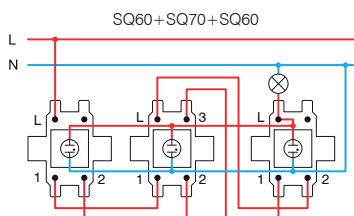
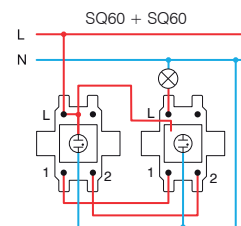
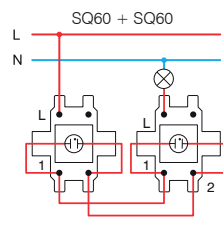
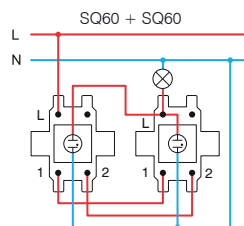
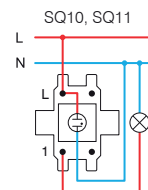
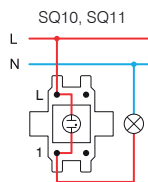
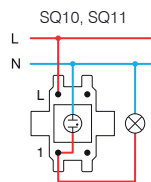

* връзките не са подходящи за енергоспестяващи крушки (CFL, LED) /
the connections are not suitable for energy-saving bulbs (CFL, LED)

S O C K E T S V Q

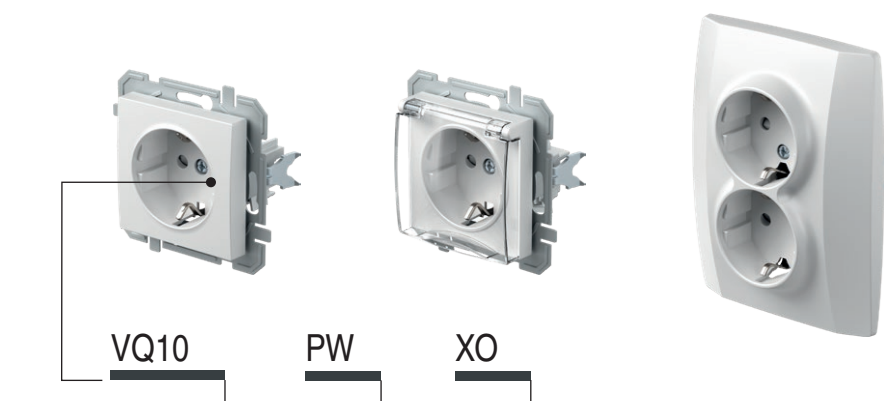

тип type	описание description	технически данни technical data	допълнителна информация 1 optional data 1
VQ10	КОНТАКТ ШУКО SOCKET SCHUKO	2P+E 16A 250V~	XO без декоративен панел without cover plate
VQ11	КОНТАКТ ШУКО+КАПАК SOCKET SCHUKO+COVER	2P+E 16A 250V~	
VQ12	КОНТАКТ ШУКО SOCKET SCHUKO	2P+E 16A 250V~ BV	
.	.	.	

ЦВЯТ
colour

<input type="checkbox"/> PW	полярно бяло polar white	<input type="checkbox"/> PT	бяло + прозрачно white+transparent	<input type="checkbox"/> PP	бяло + бяло white+white
<input type="checkbox"/> TI	титан titanium	<input type="checkbox"/> TT	титан + прозрачно titanium+transparent	<input type="checkbox"/> TI	титан + титан titanium+titanium
<input type="checkbox"/> AT	антрацит anthracite	<input type="checkbox"/> AT	антрацит + прозрачно anthracite+transparent	<input type="checkbox"/> AA	антрацит + антрацит anthracite+anthracite
<input type="checkbox"/> RD	червено red	<input type="checkbox"/> RT	червено + прозрачно red+transparent	<input type="checkbox"/> RR	червено + червено red+red
<input type="checkbox"/> GR	зелено green	<input type="checkbox"/> GT	зелено + прозрачно green+transparent	<input type="checkbox"/> GG	зелено + зелено green+green
<input type="checkbox"/> OR	оранжево orange	<input type="checkbox"/> OT	оранжево + прозрачно orange+transparent	<input type="checkbox"/> OO	оранжево + оранжево orange+orange



шuko - в съответствие с EN 60884-1, CEE7 (лист със стандарти III)

schuko - in accordance with EN 60884-1, CEE7 (standard sheet III)

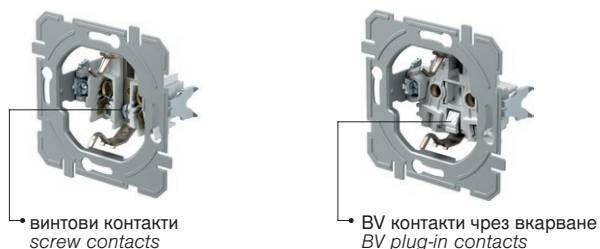

винтови контакти
screw contacts

BV контакти чрез вкарване
BV plug-in contacts

КОНТАКТ ШУКО 2P+E 16A 250V~ __ XO

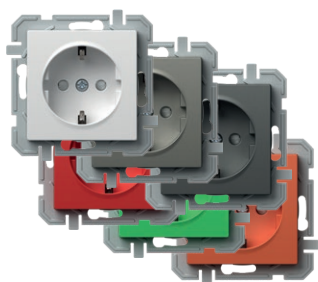

- VQ10PWXO
- VQ10TIXO
- VQ10ATXO
- VQ10RDXO
- VQ10GRXO
- VQ10ORXO

- винтови контакти 1,5-2,5 mm²
- XO без панел
- 2P+E шуко
- 16A 250V~, тип VQ10
- Вградена защита от допир на контакти



SOCKET SCHUKO 2P+E 16A 250V~ __ XO

- screw contacts 1.5-2.5mm²
- XO without surround
- 2P+E schuko
- 16A 250V~, type VQ10
- shuttered live contacts

КОНТАКТ ШУКО+КАПАК 2P+E 16A 250V~ __ XO



- VQ11PTXO
- VQ11TTXO
- VQ11ATXO
- VQ11PPXO

- винтови контакти 1,5-2,5 mm²
- XO без панел
- 2P+E шуко+капак
- 16A 250V~, тип VQ11
- Вградена защита от допир на контакти



SOCKET SCHUKO+COVER 2P+E 16A 250V~ __ XO

- screw contacts 1.5-2.5mm²
- XO without surround
- 2P+E schuko+cover
- 16A 250V~, type VQ11
- shuttered live contacts

КОНТАКТ ШУКО 2P+E 16A 250V~ BV __ XO

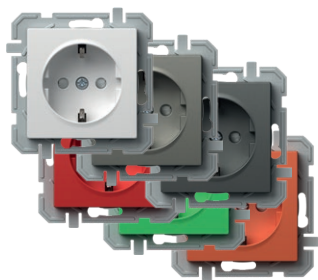

- VQ12PWXO
- VQ12TIXO
- VQ12ATXO
- VQ12RDXO
- VQ12GRXO
- VQ12ORXO

- BV контакти чрез вкарване 1,5-2,5 mm²
- XO без панел
- 2P+E шуко
- 16A 250V~, тип VQ12
- Вградена защита от допир на контакти



SOCKET SCHUKO 2P+E 16A 250V~ BV __ XO

- BV plug-in contacts 1.5-2.5mm²
- XO without surround
- 2P+E schuko
- 16A 250V~, type VQ12
- shuttered live contacts

КОНТАКТ ШУКО+КАПАК 2P+E 16A 250V~ BV __ XO



- VQ13PTXO
- VQ13TTXO
- VQ13ATXO
- VQ13PPXO

- BV контакти чрез вкарване 1,5-2,5 mm²
- XO без панел
- 2P+E шуко+капак
- 16A 250V~, тип VQ13
- Вградена защита от допир на контакти



SOCKET SCHUKO+COVER 2P+E 16A 250V~ BV __ XO

- BV plug-in contacts 1.5-2.5mm²
- XO without surround
- 2P+E schuko+cover
- 16A 250V~, type VQ13
- shuttered live contacts

КОНТАКТ ШУКО ДВОЕН 2P+E 16A 250V~



- VQ16PW
- VQ16TI
- VQ16AT

- 2P+E шуко двоен
- 16A 250V~, тип VQ16
- в съответствие с IEC 60884-1, CEE7
- винтови контакти 1,5-2,5 mm²
- Вградена защита от допир на контакти



SOCKET SCHUKO DOUBLE 2P+E 16A 250V~

- 2P+E schuko double
- 16A 250V~, type VQ16
- in accordance with IEC 60884-1, CEE7
- screw contacts 1.5-2.5 mm²
- shuttered live contacts

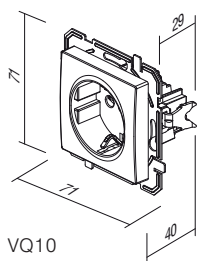

VQ10

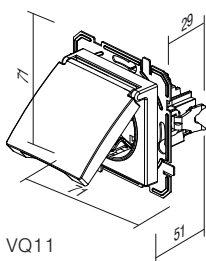

VQ11

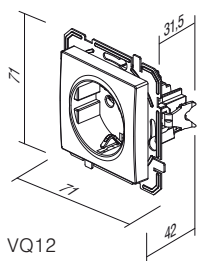

VQ12

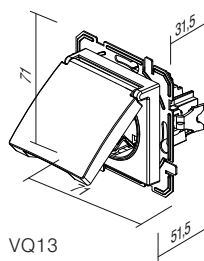

VQ13

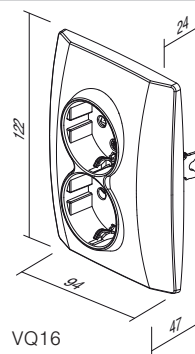

VQ16

S O C K E T S V Q



- VQ40PWXO
- VQ40TIXO
- VQ40ATXO

- VQ40RDXO
- VQ40GRXO
- VQ40ORXO

КОНТАКТ ФРЕНСКИ 2P+E 16A 250V~ __ XO

- винтови контакти 1,5 - 2,5 mm²
- XO без панел
- 2P+E френски контакт
- 16A 250V~, тип VQ40
- Вградена защита от допир на контакти

SOCKET FRENCH 2P+E 16A 250V~ __ XO

- screw contacts 1.5-2.5mm²
- XO without surround
- 2P+E French
- 16A 250V~, type VQ40
- shuttered live contacts



- VQ41PTXO
- VQ41TTXO
- VQ41ATXO

- VQ41PPXO

КОНТАКТ ФРЕНСКИ+КАПАК 2P+E 16A 250V~ __ XO

- винтови контакти 1,5 - 2,5 mm²
- XO без панел
- 2P+E френски контакт+капак
- 16A 250V~, тип VQ41
- Вградена защита от допир на контакти

SOCKET FRENCH+COVER 2P+E 16A 250V~ __ XO

- screw contacts 1.5-2.5mm²
- XO without surround
- 2P+E French+cover
- 16A 250V~, type VQ41
- shuttered live contacts



- VQ42PWXO
- VQ42TIXO
- VQ42ATXO

КОНТАКТ ФРЕНСКИ 2P+E 16A 250V~ BV __ XO

- BV контакти чрез вкарване 1,5 - 2,5 mm²
- XO без панел
- 2P+E френски контакт
- 16A 250V~, тип VQ42
- Вградена защита от допир на контакти

SOCKET FRENCH 2P+E 16A 250V~ BV __ XO

- BV plug-in contacts 1.5-2.5mm²
- XO without surround
- 2P+E French
- 16A 250V~, type VQ42
- shuttered live contacts



- VQ43PTXO
- VQ43TTXO
- VQ43ATXO

- VQ43PPXO

КОНТАКТ ФРЕНСКИ+КАПАК 2P+E 16 A 250 V~ BV __ XO

- BV контакти чрез вкарване 1,5 - 2,5 mm²
- XO без рамка
- 2P+E френски контакт+капак
- 16 A 250 V~, тип VQ43
- Вградена защита от допир на контакти

SOCKET FRENCH+COVER 2P+E 16A 250V~ BV __ XO

- BV plug-in contacts 1.5-2.5mm²
- XO without surround
- 2P+E French+cover
- 16A 250V~, type VQ43
- shuttered live contacts



- VQ46PWXO
- VQ46TIXO
- VQ46ATXO

КОНТАКТ ФРЕНСКИ ДВОЕН 2P+E 16A 250V~

- 2P+E френски двоен, 16A 250V~, тип VQ46
- в съответствие с IEC 60884-1, CEE7; NF C 61-314, CSN 33 2318; PN-E 93201
- винтови контакти 1,5 - 2,5 mm²
- Вградена защита от допир на контакти

SOCKET FRENCH DOUBLE 2P+E 16A 250V~

- 2P+E French double
- 16A 250V~, type VQ46
- in accordance with IEC 60884-1, CEE7; NF C 61-314, CSN 33 2318; PN-E 93201
- screw contacts 1.5-2.5 mm²
- shuttered live contacts

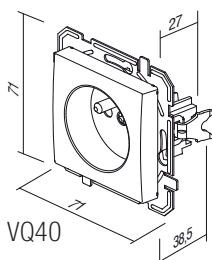

VQ40

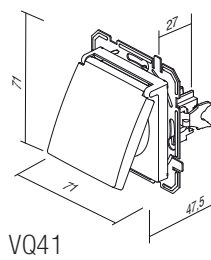

VQ41

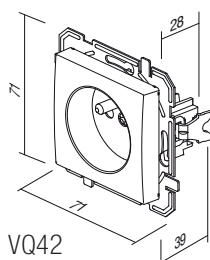

VQ42

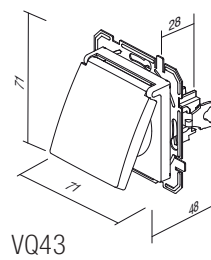

VQ43

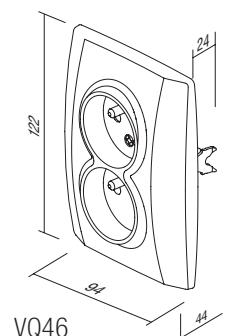

VQ46

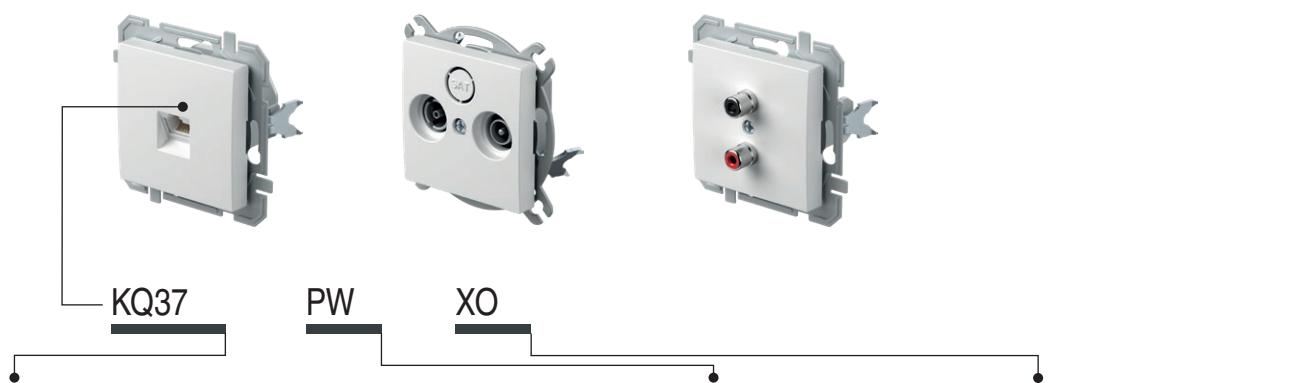

тип type	описание description	технически данни technical data	цвят colour	допълнителна информация 1 optional data 1
KQ11	КОНТАКТ ЗА ТВ-РАДИО КРАЕН SOCKET TV-R END-LINE	1dB	<input type="checkbox"/> PW полярно бяло polar white	XO без декоративен панел without cover plate
KQ12	КОНТАКТ ЗА ТВ-РАДИО ПРЕХОДЕН SOCKET TV-R THROUGHPASS	10dB	<input type="checkbox"/> TI титан titanium	
KQ16	КОНТАКТ ЗА САТЕЛИТНА ТВ-РАДИО КРАЕН SOCKET SAT-TV-R END-LINE	3dB	<input type="checkbox"/> AT антрацит anthracite	
...		

КОНТАКТ ЗА ТВ БАЗОВ 0 dB

- KQ10PWXO
- KQ10TIXO
- KQ10ATXO

- контакт за ТВ базов
- затихване 0dB
- заден конектор – стандарт F

SOCKET TV BASIC 0dB

- TV basic
- reduction 0dB
- back connector – F standard

КОНТАКТ ЗА ТВ-РАДИО КРАЕН 1 dB

- KQ11PWXO
- KQ11TIXO
- KQ11ATXO

- за ТВ-радио краен
- честотен обхват 5-862 MHz
- затихване: Радио – 1,5 dB, ТВ – 1 dB
- в съответствие с EN 50083-1
- винтов контакт

SOCKET TV-R END-LINE 1dB

- TV-R end-line
- frequency range 5-862 MHz
- reduction: R-1.5dB, TV-1dB
- in accordance with EN 50083-1
- screw contact

КОНТАКТ ЗА ТВ-РАДИО ПРЕХОДЕН 10 dB

- KQ12PWXO
- KQ12TIXO
- KQ12ATXO

- за ТВ-радио преходен
- честотен обхват 5-862 MHz
- затихване: Радио – 10 dB, ТВ – 10 dB, преход – 2 dB
- в съответствие с EN 50083-1
- винтови контакти

SOCKET TV-R TROUGHPASS 10dB

- TV-R troughpass
- frequency range 5-862 MHz
- reduction: R-10dB, TV-10dB, trough-2dB
- in accordance with EN 50083-1
- screw contacts

КОНТАКТ ЗА САТЕЛИТНА ТВ-РАДИО КРАЕН 3 dB

- KQ16PWXO
- KQ16TIXO
- KQ16ATXO

- за сателитна ТВ-радио краен
- честотен обхват 5-2400 MHz
- затихване: Радио – 1 dB, ТВ – 1,5 dB, сателитна ТВ – 3 dB
- в съответствие с EN 50083-1
- винтови контакти

SOCKET SAT-TV-R END-LINE 3dB

- SAT-TV-R end-line
- frequency range 5-2400 MHz
- reduction: R-1dB, TV-1.5dB, SAT-3dB
- in accordance with EN 50083-1
- screw contacts

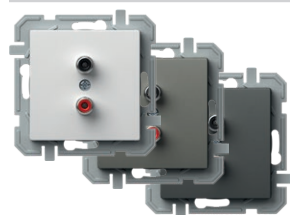

- KQ22PWXO
- KQ22TIXO
- KQ22ATXO

КОНТАКТ ЗА АУДИОСИГНАЛИ 2xRCA

- за аудиосигнали 2xRCA
- свързване на кабела чрез запояване

SOCKET AUDIO 2xRCA

- audio 2xRCA
- soldering connection of cable



- KQ23PWXO
- KQ23TIXO
- KQ23ATXO

КОНТАКТ ЗА ВИСОКОГОВОРТЕЛИ

- за аудиосигнали 2x Ø4 mm
- за проводник за високоговорители, с щепсел тип банан Ø4 mm или плоски конектори
- свързване на кабела от задната страна чрез запояване

SOCKET AUDIO LOUDSPEAKERS

- audio 2x Ø4mm
- to accommodate speaker wire, banana plug Ø4mm or spades
- soldering connection of cable at the back side

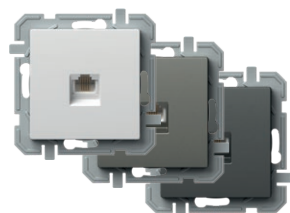

- KQ36PWXO
- KQ36TIXO
- KQ36ATXO

КОНЕКТОР ЗА ТЕЛЕФОН KS RJ11 6/4

- KS модул стандарт за закрепване
- RJ11 6/4
- в съответствие с IEC 60603-7

SOCKET TEL KS RJ11 6/4

- KS keystone fixing standard
- RJ11 6/4
- in accordance with IEC 60603-7

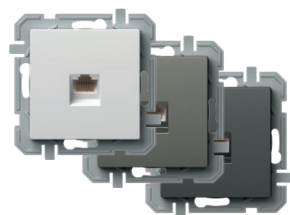

- KQ37PWXO
- KQ37TIXO
- KQ37ATXO

КОНЕКТОР CAT5e KS RJ45 8/8

- KS модул стандарт за закрепване
- CAT5e, RJ45 8/8
- в съответствие с IEC 60603-7

SOCKET CAT5e KS RJ45 8/8

- KS keystone fixing standard
- CAT5e, RJ45 8/8
- in accordance with IEC 60603-7

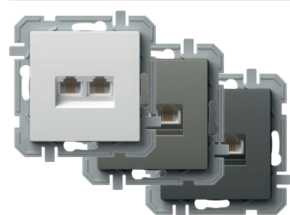

- KQ38PWXO
- KQ38TIXO
- KQ38ATXO

КОНЕКТОР ЗА ТЕЛЕФОН KS ДВОЕН 2x RJ11 6/4

- KS модул стандарт за закрепване
- 2x RJ11, 6/4
- в съответствие с IEC 60603-7

SOCKET TEL KS DOUBLE 2x RJ11 6/4

- KS keystone fixing standard
- 2x RJ11, 6/4
- in accordance with IEC 60603-7

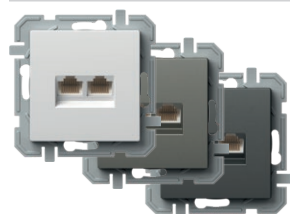

- KQ39PWXO
- KQ39TIXO
- KQ39ATXO

КОНЕКТОР CAT5e KS ДВОЕН 2x RJ45 8/8

- KS модул стандарт за закрепване
- 2x CAT5e, RJ45 8/8
- в съответствие с IEC 60603-7

SOCKET CAT5e KS DOUBLE 2x RJ45 8/8

- KS keystone fixing standard
- 2x CAT5e, RJ45 8/8
- in accordance with IEC 60603-7

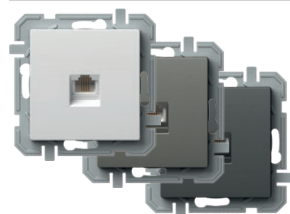

- KQ35PWXO
- KQ35TIXO
- KQ35ATXO

КОНЕКТОР ЗА ТЕЛЕФОН LT RJ11 6/4

- телефонен LT винтов
- винтови контакти
- RJ11 6/4
- в съответствие с IEC 60603-7

SOCKET TEL LT RJ11 6/4

- TEL LT screw
- screw contacts
- RJ11 6/4
- in accordance with IEC 60603-7



КОНЕКТОР CAT6s KS RJ45 8/8 SLIM

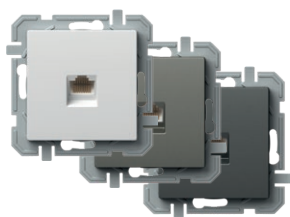

- KQ40PWXO
- KQ40TIXO
- KQ40ATXO

- KS модулен стандарт за закрепване
 - CAT6s, RJ45 8/8
 - в съответствие с IEC 60603-7

SOCKET CAT6s KS RJ45 8/8 SLIM

- KS keystone fixing standard
 - CAT6s, RJ45 8/8
 - in accordance with IEC 60603-7



КОНЕКТОР CAT6s KS ДВОЕН 2x RJ45 8/8 SLIM

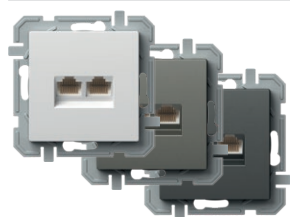

- KQ41PWXO
- KQ41TIXO
- KQ41ATXO

- KS модулен стандарт за закрепване
 - 2x CAT6s, RJ45 8/8
 - в съответствие с IEC 60603-7

SOCKET CAT6s KS DOUBLE 2x RJ45 8/8 SLIM

- KS keystone fixing standard
 - 2x CAT6s, RJ45 8/8
 - in accordance with IEC 60603-7

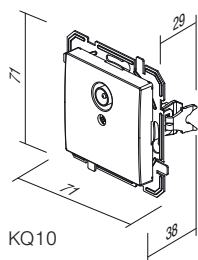

KQ10

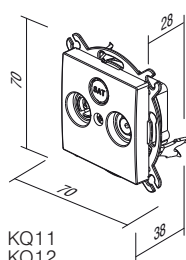

KQ11
KQ12

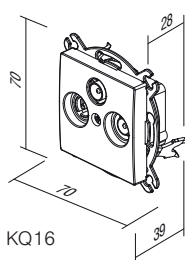

KQ16

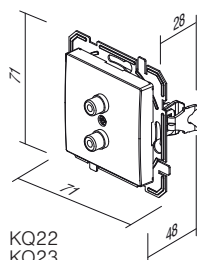

KQ22
KQ23

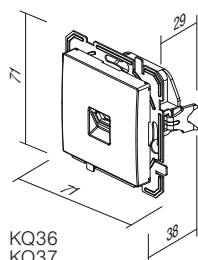

KQ36
KQ37
KQ35
KQ40

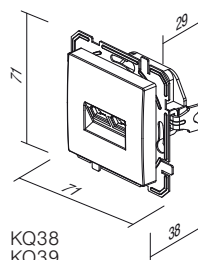

KQ38
KQ39
KQ41



EQ15

PW

XO

тип type	описание description	технически данни technical data	цвет colour	допълнителна информация 1 optional data 1
EQ15	ДИМЕР, ВЪРТЯЩ ТИП, ДВУПОСОЧЕН DIMMER ROTATIVE 2WAY	RL 400W	□ PW полярно бяло polar white	XO без декоративен панел without cover plate
EQ16	ДИМЕР, ВЪРТЯЩ ТИП, ДВУПОСОЧЕН DIMMER ROTATIVE 2WAY	RLC 400W	■ TI титан titanium	
EQ19	ДИМЕР, ВЪРТЯЩ ТИП, ДВУПОСОЧЕН DIMMER ROTATIVE 2WAY	LED 100W	■ AT антрацит anthracite	
⋮				

ДИМЕР, ВЪРТЯЩ ТИП, ДВУПОСОЧЕН, АКТИВЕН/ИНДУКТИВЕН ТОВАР 400 W



- EQ15PWXO
- EQ15TIXO
- EQ15ATXO

- управление чрез завъртане, с двупосочен ключ
- активен/индуктивен товар, 40 W - 400 W
- възможна е комбинация с двупосочен ключ
- не се допуска комбинация с допълнителни димери
- в съответствие с EN 60669-1 and EN 60669-2-1
- контакти чрез вкарване на проводниците 1,5 mm²
- захранващо напрежение 230 V~ 50 Hz
- предпазител за смяна е включен в доставката



DIMMER ROTATIVE 2WAY RL 400W

- rotation control with 2-way switch
- load RL, 40W - 400W
- 2-way switch combination is possible
- more dimmers combination is not allowed
- in accordance with EN 60669-1 and EN 60669-2-1
- plug-in contacts 1,5mm²
- supply 230V~ 50Hz
- replaceable fuse included

ДИМЕР, ВЪРТЯЩ ТИП, ДВУПОСОЧЕН, АКТИВЕН/ИНДУКТИВЕН/КАПАЦИТИВЕН ТОВАР 400 W

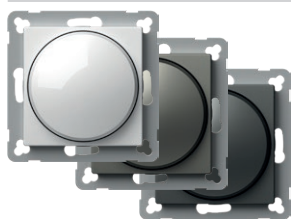

- EQ16PWXO
- EQ16TIXO
- EQ16ATXO

- управление чрез завъртане, с двупосочен ключ
- активен/индуктивен/капацитивен товар, 20 W - 400 W
- възможна е комбинация с двупосочен ключ
- не се допуска комбинация с допълнителни димери
- в съответствие с EN 60669-1 and EN 60669-2-1
- контакти чрез вкарване на проводниците 1,5 mm²
- захранващо напрежение 230 V~ 50 Hz
- електронен предпазител



DIMMER ROTATIVE 2WAY RLC 400W

- rotation control with 2-way switch
- load RLC, 20W - 400W
- 2-way switch combination is possible
- more dimmers combination is not allowed
- in accordance with EN 60669-1 and EN 60669-2-1
- plug-in contacts 1,5mm²
- supply 230V~ 50Hz
- electronic fuse

ДИМЕР, ВЪРТЯЩ ТИП, ДВУПОСОЧЕН, ЗА СВЕТОДИОДНО ОСВЕТЛЕНИЕ 100 W



- EQ19PWXO
- EQ19TIXO
- EQ19ATXO

- управление чрез завъртане, с двупосочен ключ
- това: светодиодно осветление, 0-100 W
(макс. 10 светодиода)
- GLS, 10-250 W
- възможна е комбинация с двупосочен ключ
- не се допуска комбинация с допълнителни димери
- в съответствие с EN 60669-1 and EN 60669-2-1
- контакти чрез вкарване на проводниците 1,5 mm²
- захранващо напрежение 230 V~ 50 Hz
- предпазител за смяна е включен в доставката



DIMMER ROTATIVE 2WAY LED 100W

- rotation control with 2-way switch
- load: LED, 0-100W (max. 10 LEDs)
- GLS, 10-250W
- 2-way switch combination is possible
- more dimmers combination is not allowed
- in accordance with EN 60669-1 and EN 60669-2-1
- plug-in contacts 1,5mm²
- supply 230V~ 50Hz
- replaceable fuse included

EQ15, EQ16, EQ19

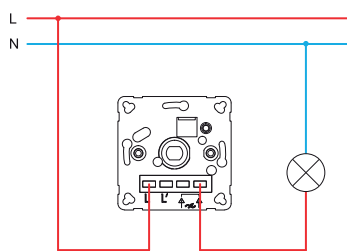

EQ15, EQ16, EQ19

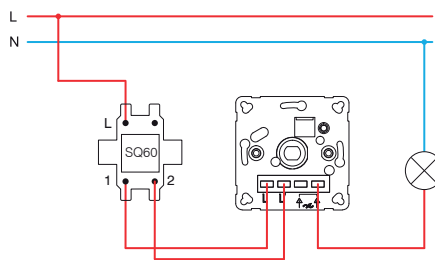

EQ15, EQ16, EQ19

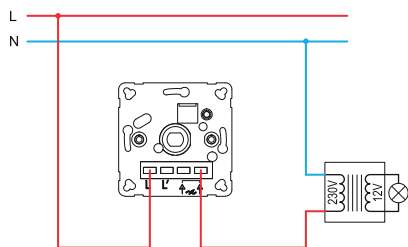

EQ15, EQ16, EQ19

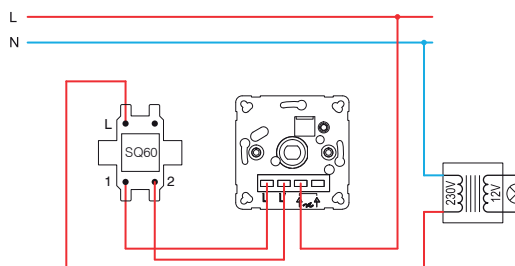

EQ16, EQ19

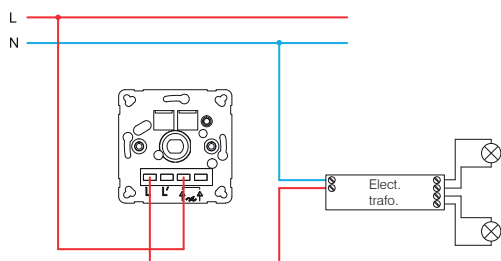

EQ16, EQ19

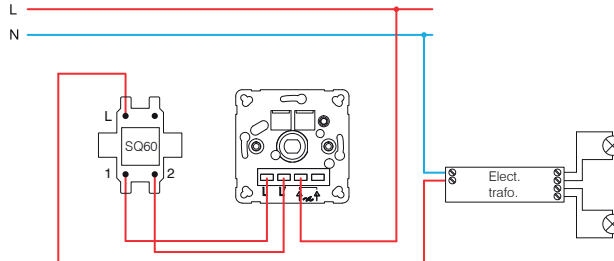

EQ15 (40÷400W)

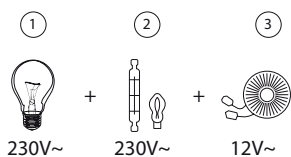

- 1 - лампа с нажежаема жичка
incandescent lamp
- 2 - халогенна лампа
halogen lamp

EQ16 (20÷400W)

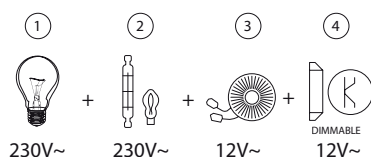

- 3 - класически трансформатор
classical transformer
- 4 - димиращ електронен трансформатор
dimnable electronic transformer

EQ19 (GLS 10÷250W ; LED 0÷100W)

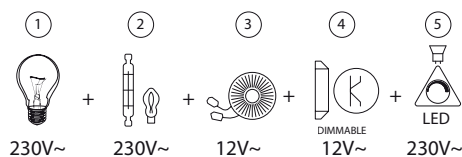

- 5 - димируема светодиодна лампа
dimnable LED lamp

ИЧ КЛЮЧ 5А 230V~



- EQ32PWXO
- EQ32TIXO
- EQ32ATXO

- инфрачервен ключ IR
- захранващо напрежение: 230V~ ±10% 50 Hz
- реле: 5A / 250V~ изход за ограничен ток с висока устойчивост за нулевата стойност
- клас на защита: IP40
- сечение на проводниците при контакта: 0,75 - 2,5 mm²
- ъгъл на откриване: до 110° при 20°C
- разстояние на откриване: прил. 8 m при 20°C
- регулируема продължителност: от прил. 5 сек до 12 мин
- регулиране на яркостта на осветлението: от прил. 5 до 200 лукса
- работна температура: от 0°C до +40°C
- не е подходящо за инсталиране в конзоли с дълбочина 45 mm
- само за употреба на закрито

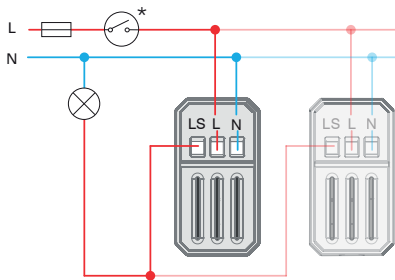

IR SWITCH 5A 230V~

- IR infrared switch
- supply voltage: 230V~ ±10 % 50Hz
- relay: 5A / 250V~ output for limited current with high resistance for zero crossing
- protection rating: IP40
- cross-section of wires at the contact terminal: 0.75 - 2.5 mm²
- detection angle: up to 110° at 20°C
- detection area: approx. 8 m at 20°C
- adjustability of duration: from approx. 5 s to 12 min
- adjustability of brightness: from approx. 5 to 200 LUX
- operating temperature: from 0°C to +40°C
- not suitable for installation in 45 mm deep boxes
- only for indoor usage

ОТОПЛЕНИЕ С ТЕРМОСТАТ 10А 230V~

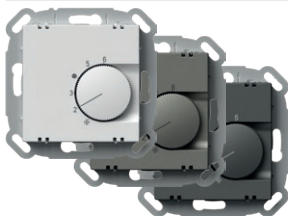

- EQ35PWXO
- EQ35TIXO
- EQ35ATXO

- работен режим: отопление
- захранване: 230 V~, 50 Hz
- изход: 4 A (макс. 10 A), 230 V~, 50 Hz
- комутационен контактор: NC (макс. 10 устройства)
- обхват на регулиране: +5°C до +30°C
- хистерезис: 0,5 K
- защита: IP30
- тип датчик: биметален
- тип електрическа връзка: пружинно натоварени контакти
- типове проводници: 0,75 – 1,5 mm² (гъвкаво-вплетена основа) или 1,0 – 2,5 mm² (солидна основа)

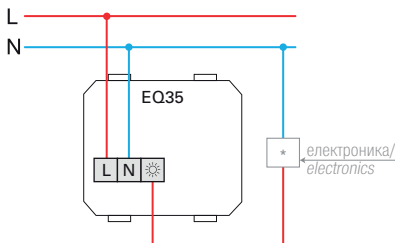

THERMOSTAT HEATING 10A 230V~

- operation mode: heating
- power supply: 230 V~, 50 Hz
- output: 4 A (max. 10 A), 230 V~, 50 Hz
- switching contact: NC (max. 10 actuators)
- regulation range: +5 °C to +30 °C
- hysteresis: 0,5 K
- protection: IP30
- sensor type: bimetal
- type of electrical connection: spring-loaded contacts
- type of conductors: 0,75 – 1,5mm² (flexible-stranded core) or 1,0 – 2,5 mm² (solid core)

ОТОПЛЕНИЕ/ОХЛАЖДАНЕ С ТЕРМОСТАТ 5А 230V~

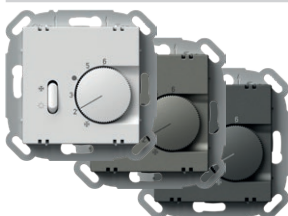

- EQ36PWXO
- EQ36TIXO
- EQ36ATXO

- работен режим: отопление/охлаждане
- захранване: 230 V~, 50 Hz
- изход: 2 A (макс. 5 A), 230 V~, 50 Hz
- комутационен контактор: превключващ ключ (превключвател, макс. 5 устройства)
- обхват на регулиране: +5°C до +30°C
- хистерезис: 0,5 K
- защита: IP30
- тип датчик: биметален
- тип електрическа връзка: пружинно натоварени контакти
- типове проводници: 0,75 – 1,5 mm² (гъвкаво-вплетена основа) или 1,0 – 2,5 mm² (солидна основа)

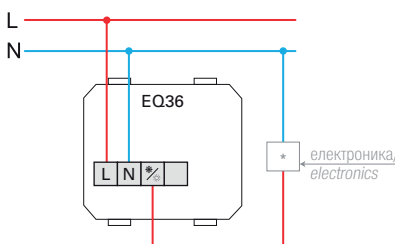

THERMOSTAT HEATING / COOLING 5A 230V~

- operation mode: heating / cooling
- power supply: 230 V~, 50 Hz
- output: 2 A (max. 5 A), 230 V~, 50 Hz
- switching contact: changeover switch (toggler, max. 5 actuators)
- regulation range: +5 °C to +30 °C
- hysteresis: 0,5 K
- protection: IP30
- sensor type: bimetal
- type of electrical connection: spring-loaded contacts
- type of conductors: 0,75 – 1,5mm² (flexible-stranded core) or 1,0 – 2,5 mm² (solid core)

ПОДОВО ОТОПЛЕНИЕ С ТЕРМОСТАТ 16A 230V~

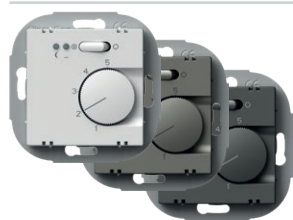

- EQ37PWXO
- EQ37TIXO
- EQ37ATXO

- работен режим: подово отопление
- захранване: 230 V~, 50 Hz
- изход: 2 A (макс. 16 A), 230 V~, 50 Hz
- обхват на регулиране: +10 °C до +50 °C
- хистерезис: 1 K
- защита: IP30
- тип датчик: NTC в съответствие с DIN EN 60730-2-1
- индикатори: Червен светодиод за отопление и зелен светодиод за режим на намаляване през нощта
- тип електрическа връзка: Винтови контакти
- типове проводници: 0,5 - 2,5 mm²

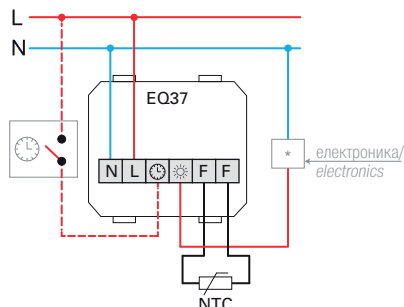

THERMOSTAT FLOOR HEATING 16A 230V~

- operation mode: floor heating
- power supply: 230 V~, 50 Hz
- output: 2 A (max. 16 A), 230 V~, 50 Hz
- regulation range: +10 °C to +50 °C
- hysteresis: 1 K
- protection: IP30
- sensor type: NTC in compliance with DIN EN 60730-2-1
- indicators: Red LED for heating and green LED for night decrease mode
- type of electrical connection: Screw contacts
- type of conductors: 0,5 - 2,5mm²

USB ЗАХРАНВАЦ БЛОК 5 V 3,0 A



- EQ68PW
- EQ68TIXO
- EQ68ATXO

- за зареждане на електронни устройства чрез стандартен USB порт (съвместим и с устройства на Apple)
- захранване: 100-230 V~ 50/60 Hz
- консумация на енергия: 300mA при 100V~/150mA при 230V~
- консумация на енергия в режим на готовност: 30mW при 230V~
- номинално изходно напрежение: 5 VCD (± 5%) SELV
- изходно напрежение на пулсации: 150 mV
- номинален изходен ток: 3,0 A (±10%)
- вид конектор: USB A/USB C
- ефективност: максимум 77%
- температура на работа: 0 °C/+45 °C (за употреба в затворени пространства)
- Клас на IP защита: IP20, само за употреба в затворени пространства
- устройство клас II
- категория свръхнапрежение (EN 62109): Клас III
- винтови контакти: макс. 2,5 mm²
- устройство с контактна междина най-малко 3 mm
- в съответствие с Директива EN 60950-1 и Директива за безопасност на нисковолтови електрически съоръжения (LVD) и Директива относно електромагнитна съвместимост (EMC)



USB POWER SUPPLY UNIT 5V 3.0A

- for charging electronic devices via a standard USB port (also compatible with Apple devices)
- power supply: 100-230V~ 50/60Hz
- power consumption: 300mA at 100V~/150mA at 230V~
- standby power consumption: 30mW at 230V~
- nominal output voltage: 5 VCD (± 5%) SELV
- output ripple voltage: 150mV
- nominal output current: 3.0 A (±10%)
- connector type: USB A / USB C
- efficiency: maximum of 77%
- operating temperature: 0 °C/+45 °C (indoor use)
- IP protection class: IP20, indoor use only
- class device II
- overvoltage category (EN 62109): Class III
- screw contacts: max. 2.5 mm²
- device with a contact gap of at least 3mm
- in accordance with the EN 60950-1 and LVD & EMC directives

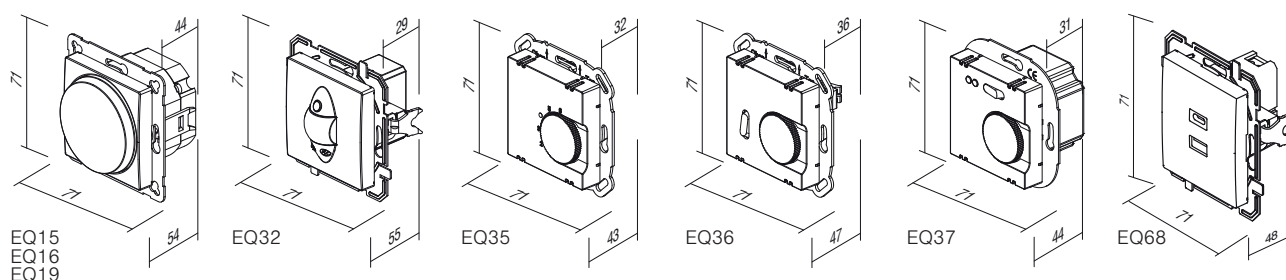

A C C E S S O R I E S P Q

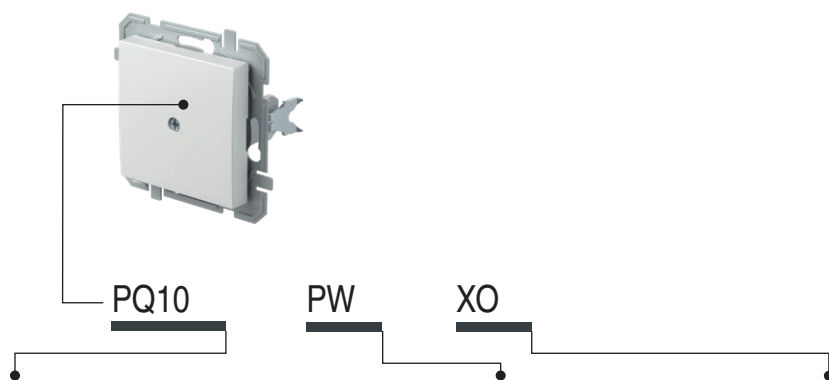

тип type	описание description	цвят colour	допълнителна информация 1 optional data 1
PQ10	КАПАЧЕ BLANK	□ PW полярно бяло polar white	XO без декоративен панел without cover plate
PQ30	ПАНЕЛ TAE/TDO COVER TAE/TDO	■ TI титан titanium ■ AT антрацит anthracite	

КАПАЧЕ



- PQ10PWXO
- PQ10TIXO
- PQ10ATXO

- за запълване на празни позиции
BLANK
- for filling up empty spaces



ПАНЕЛ TAE/TDO

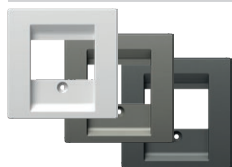

- PQ30PW
- PQ30TI
- PQ30AT

- TAE или TDO панел с винт
COVER TAE/TDO
- TAE or TDO cover with screw

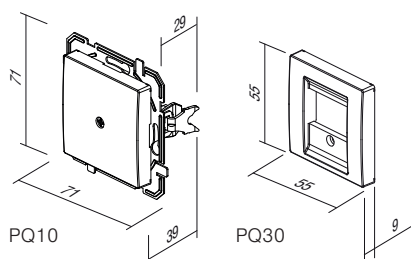

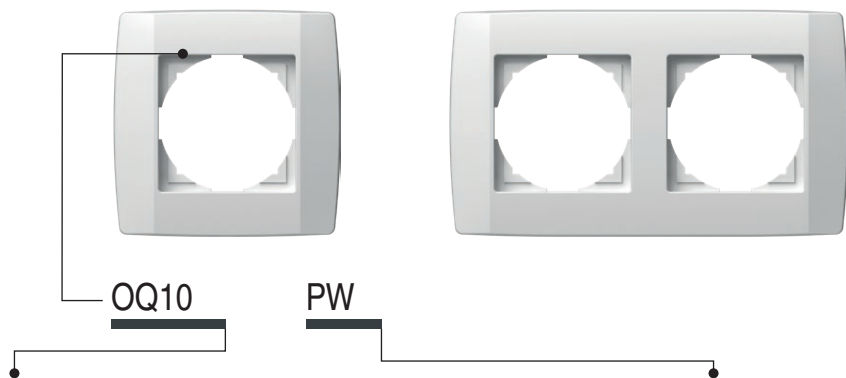

тип type	описание description	ЦВЯТ colour
OQ10	ПАНЕЛ LOGIQ 1 COVER PLATE LOGIQ 1	PW полярно бяло polar white
OQ20	ПАНЕЛ LOGIQ 2 COVER PLATE LOGIQ 2	ТI титан titanium
OQ30	ПАНЕЛ LOGIQ 3 COVER PLATE LOGIQ 3	АТ антрацит anthracite
.	.	.



- OQ10PW
- OQ10TI
- OQ10AT

ПАНЕЛ LOGIQ 1

- декоративен панел 1-gang
- в съответствие с EN 60669-1
COVER PLATE LOGIQ 1
- decorative cover plate 1-gang
- in accordance with EN 60669-1

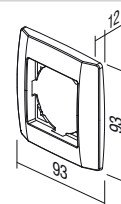

- OQ20PW
- OQ20TI
- OQ20AT

ПАНЕЛ LOGIQ 2

- декоративен панел 2-gang
- в съответствие с EN 60669-1
COVER PLATE LOGIQ 2
- decorative cover plate 2-gang
- in accordance with EN 60669-1

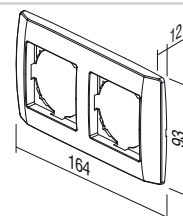



OQ30PW
 OQ30TI
 OQ30AT

ПАНЕЛ LOGIQ 3

- декоративен панел 3-gang
- в съответствие с EN 60669-1

COVER PLATE LOGIQ 3
- decorative cover plate 3-gang
- in accordance with EN 60669-1

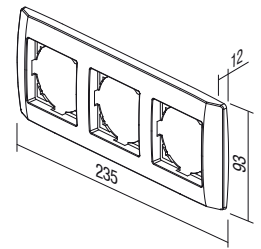

OQ40PW
 OQ40TI
 OQ40AT

ПАНЕЛ LOGIQ 4

- декоративен панел 4-gang
- в съответствие с EN 60669-1

COVER PLATE LOGIQ 4
- decorative cover plate 4-gang
- in accordance with EN 60669-1

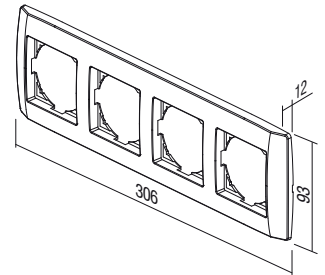

OQ50PW
 OQ50TI
 OQ50AT

ПАНЕЛ LOGIQ 5

- декоративен панел 5-gang
- в съответствие с EN 60669-1

COVER PLATE LOGIQ 5
- decorative cover plate 5-gang
- in accordance with EN 60669-1

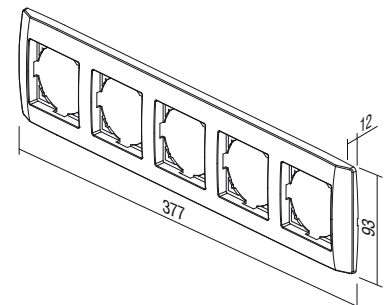

TEM

ekonomik





ekonomik

ПЛАНИРАНИ ЗА ПОСТИГАНЕ НА СЪВЪРШЕНСТВО Стилът е важен

Неутрален, компактен, елегантен стил, който се вписва във всяка работна или жилищна зона. В интериора нищо не се набива в очи, а по-скоро хармонично му пасва.

PLANNED FOR EXCELLENCE Style is essential

A neutral, compact, elegant design is adjustable to every working or living area. It does not stick out from the interior, but rather harmonically fits into it.





ekonomik

ХАРМОНИЯ НА ЦВЕТОВЕТЕ Изберете своя нюанс

Желанията могат да бъдат най-различни. Затова ние внимателно сме подбрали възможности за вас, които може да ви предоставят правилния отговор. Неутрална палитра от цветове само ще допълни вашата среда – а няма да я ограничава.

HARMONY OF COLOURS Choose your hue

Desires can be very different. Therefore we have carefully selected possibilities for you, which can offer you the right answer. A neutral palette of colours will only complement your ambient - it will not restrict it.

- | | | |
|-----------------------------|--------------------------|------------------------|
| <input type="checkbox"/> PW | полярно бяло | <i>polar white</i> |
| <input type="checkbox"/> IW | слонова кост | <i>ivory white</i> |
| <input type="checkbox"/> ES | елоксирано сребро | <i>elox silver</i> |
| <input type="checkbox"/> CO | термоактивно бяло | <i>white thermoset</i> |
| <input type="checkbox"/> NB | нощно черно | <i>night black</i> |





ОПТОСТЕНО ЗА НАЙ-ВЗИСКАТЕЛНИТЕ

Чрез грижливо планиране елементите под напрежение са защитени срещу докосване. Основното закрепване на механизмите чрез закрепващи крачета (1) дава възможност за допълнително заздравяване с винтове (2). Този начин е особено подходящ за безопасно и надеждно закрепване на контакти.

SIMPLE FOR THE MOST DEMANDING

By careful planning elements under voltage have been protected against touching. Basic fixing of mechanisms with fixing claws (1) allows additional strengthening with screws (2). This manner is especially appropriate for safe and reliable fixing of sockets.

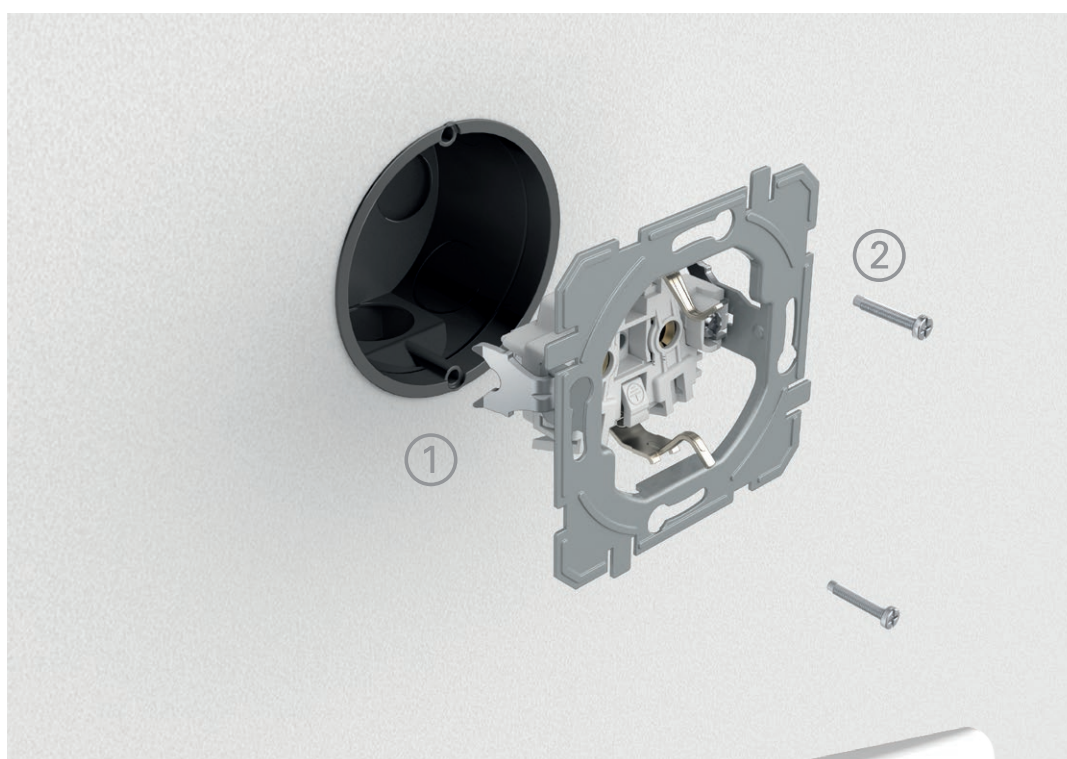

КОМБИНИРАЙТЕ КАКТО ВИ СЕ ИСКА.
COMBINE AS YOU PLEASE.



Комбинирайки, вие икономисвате място върху стената. Когато се сблъсквате с ограничено място, »вертикално« е правилното решение.

With combining you save space on the wall. When faced with a limited space, »vertically« is the right decision.

ЛЕСЕН МОНТАЖ

Економик е решение за системата от стандартизирани кръгли инсталационни кутии. Може да се използва както за прости, така и за по-взискателни инсталации, нови сгради и приспособления. Системата се характеризира с контакти чрез вкарване, които спестяват време при монтажа на елементите.

EASY INSTALLATION

Ekonomik is a solution for the system of standardized round installations boxes. It can be used for simple as well as more demanding installations, new buildings and adaptations. The system is characterised by plug-in contacts which save time during installation of elements.

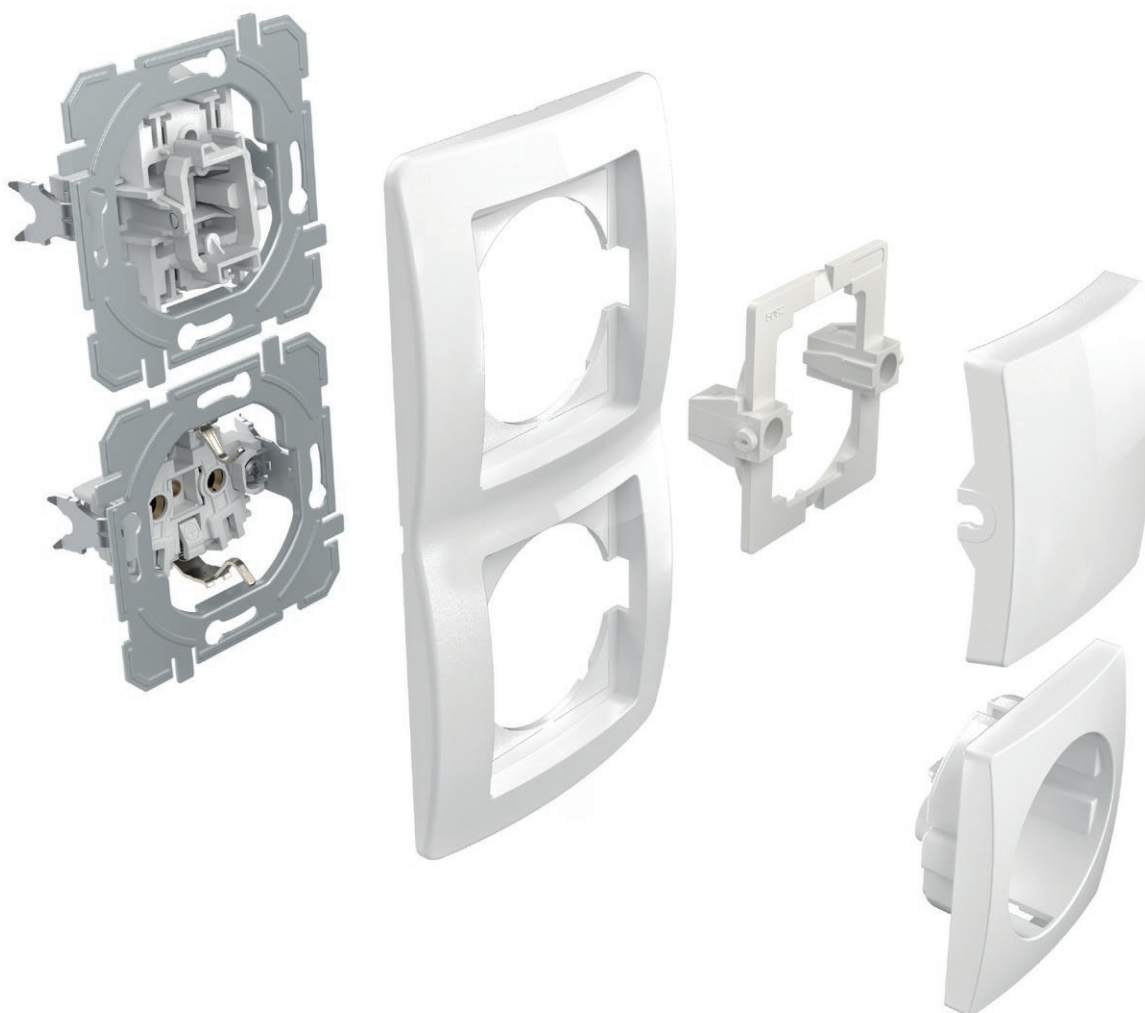

ДОБРЕ Е ДА ЗНАЕТЕ

GOOD TO KNOW



Всички контакти са оборудвани за безопасно изключване, което гарантира защитата на контактите, които са под напрежение.

All the sockets are equipped with a safety shutters assuring the protection to live contacts.



Добре обмислената конструкция на ключа позволява и допълнително лесна индикация.

The well-thought-out design of the switch enables the easy integration of the indication, including at a later time.



Надеждността на превключването се гарантира от контакти от сребърна сплав.

Contacts made of silver alloy guarantee safe switching.



Контактите, осъществявани чрез вкарване на проводниците, позволява бързо и надеждно закрепване на проводниците. Два проводника с различни диаметри може да се свържат към един и същи контакт.

Plug-in contacts enable quick and reliable attachment of wires. Two wires of different diameters can be attached to the same contact.



Закрепващите крачета дават възможност за по-дълбоко закрепване (също така и през керамични плочки и подобни)

Fixing claws enable deeper fixing (also through ceramic tiles, etc.)



Лесните за монтиране инсталационни конзоли ще улеснят работата ви. Правилните дължини са гарантирани.

Easy-fitting installation boxes will make your work easier. Proper lengths are guaranteed.

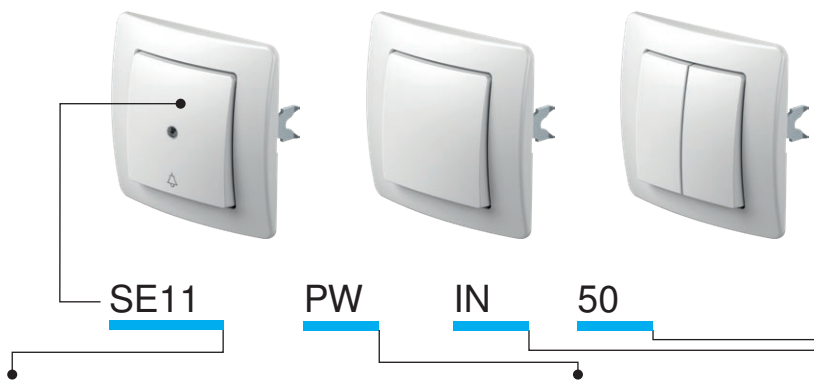

тип type	описание description	технически данни technical data	цвет colour	допълнителна информация 1 optional data 1	допълнителна информация 2 optional data 2
SE10	КЛЮЧ 1WAY SWITCH 1WAY	10AX 250V~	<input type="checkbox"/> PW снежнобял polar white	NT неутрален neutral	50
SE11	БУТОН 1WAY PUSH BUTTON 1WAY	10A 250V~	<input type="checkbox"/> IW слонова кост ivory white		51
SE22	КЛЮЧ 2POLE SWITCH 2POLE	16AX 250V~	<input type="checkbox"/> ES сребрист elox silver <input type="checkbox"/> CO бял с термореактивен material white thermoset	IN индикатор indicator	03 04
...	<input type="checkbox"/> NB тъмночерен night black		...

КЛЮЧ 1WAY 10AX 250V~

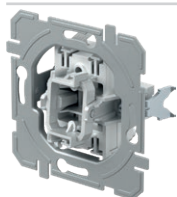

SE10

- 10AX 250V~, тип SE10
- в съответствие с EN 60669-1
- контакти чрез вкарване 1,5 - 2,5 mm²



SWITCH 1WAY 10AX 250V~

- 10AX 250V~, type SE10
- in accordance with EN 60669-1
- plug-in contacts 1.5-2.5mm²

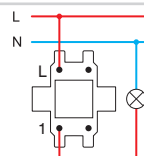

БУТОН 1WAY 10A 250V~

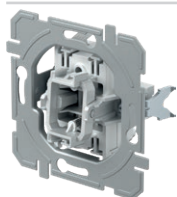

SE11

- 10A 250V~, тип SE11
- в съответствие с EN 60669-1
- контакти чрез вкарване 1,5 - 2,5 mm²



PUSH BUTTON 1WAY 10A 250V~

- 10A 250V~, type SE11
- in accordance with EN 60669-1
- plug-in contacts 1.5-2.5mm²

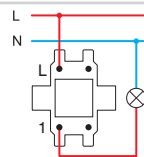

КЛЮЧ 2POLE 16AX 250V~

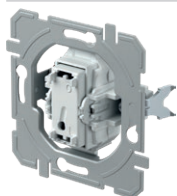

SE22

- 16AX 250V~, тип SE22
- в съответствие с EN 60669-1
- винтови контакти 1,5 - 2,5 mm²
- само в комбинация с бутон TE10__NT03

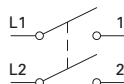

SWITCH 2POLE 16AX 250V~

- 16AX 250V~, type SE22
- in accordance with EN 60669-1
- screw contacts 1.5-2.5mm²
- only in combination with button TE10__NT03

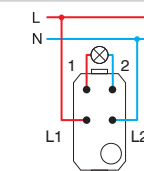

КЛЮЧ 2GANG-1WAY 10AX 250V~

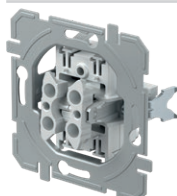

SE50

- 10AX 250V~, тип SE50
- в съответствие с EN 60669-1
- контакти чрез вкарване 1,5 - 2,5 mm²

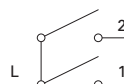

SWITCH 2GANG-1WAY 10AX 250V~

- 10AX 250V~, type SE50
- in accordance with EN 60669-1
- plug-in contacts 1.5-2.5mm²

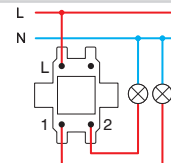

S W I T C H E S S E

БУТОН 2GANG-1WAY 10A 250V~

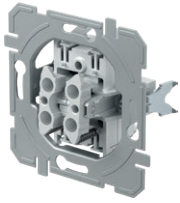

SE51

- 10 A 250 V~, тип SE51
- в съответствие с EN 60669-1
- контакти чрез вкарване 1,5 - 2,5 mm²

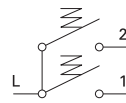

PUSH BUTTON 2GANG-1WAY 10A 250V~

- 10A 250V~, type SE51
- in accordance with EN 60669-1
- plug-in contacts 1.5-2.5mm²

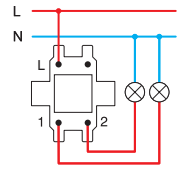

КЛЮЧ ЗА ЩОРИ 10AX 250V~

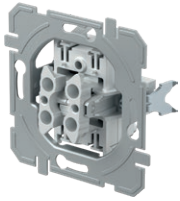

SE52

- 10AX 250 V~, тип SE52
- в съответствие с EN 60669-1
- контакти чрез вкарване 1,5 - 2,5 mm²
- с механична блокировка

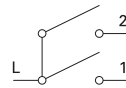

SWITCH SHUTTERS 10AX 250V~

- 10AX 250V~, type SE52
- in accordance with EN 60669-1
- plug-in contacts 1.5-2.5mm²
- with mechanical interblock

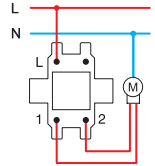

БУТОН ЗА ЩОРИ 10A 250V~

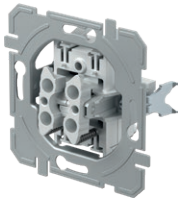

SE53

- 10A 250V~, тип SE53
- в съответствие с EN 60669-1
- контакти чрез вкарване 1,5 - 2,5 mm²
- с механична блокировка

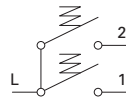

PUSH BUTTON SHUTTERS 10A 250V~

- 10A 250V~, type SE53
- in accordance with EN 60669-1
- plug-in contacts 1.5-2.5mm²
- with mechanical interblock

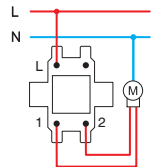

КЛЮЧ 2WAY 10AX 250V~

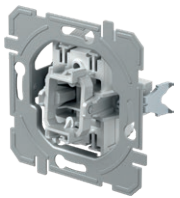

SE60

- 10AX 250V~, тип SE60
- в съответствие с EN 60669-1
- контакти чрез вкарване 1,5 - 2,5 mm²

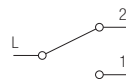

SWITCH 2WAY 10AX 250V~

- 10AX 250V~, type SE60
- in accordance with EN 60669-1
- plug-in contacts 1.5-2.5mm²

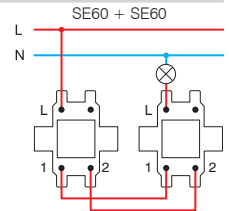

ДВОЕН КЛЮЧ 2WAY 10AX 250V~

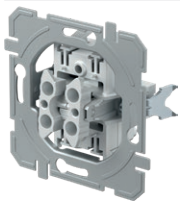

SE63

- 10AX 250V~, тип SE63
- в съответствие с EN 60669-1
- контакти чрез вкарване 1,5 - 2,5 mm²



SWITCH DOUBLE 2WAY 10AX 250V~

- 10AX 250V~, type SE63
- in accordance with EN 60669-1
- plug-in contacts 1.5-2.5mm²

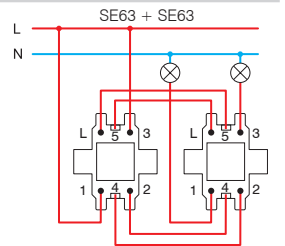

КРЪСТАТ КЛЮЧ 10AX 250V~

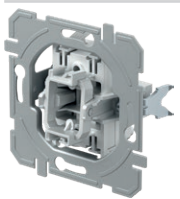

SE70

- 10AX 250V~, тип SE70
- в съответствие с EN 60669-1
- контакти чрез вкарване 1,5 - 2,5 mm²



SWITCH INTERMEDIATE 10AX 250V~

- 10AX 250V~, type SE70
- in accordance with EN 60669-1
- plug-in contacts 1.5-2.5mm²

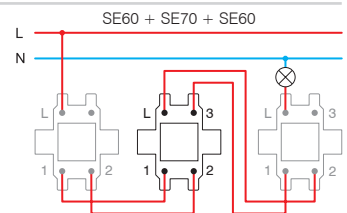



- SE10PW
- SE10IW
- SE10ES
- SE10CO
- SE10NB

КЛЮЧ 1WAY 10AX 250V~

- 10AX 250V~, тип SE10
- в съответствие с EN 60669-1
- контакти чрез вкарване 1,5 - 2,5 mm²

SWITCH 1WAY 10AX 250V~
 - 10AX 250V~, type SE10
 - in accordance with EN 60669-1
 - plug-in contacts 1.5-2.5mm²

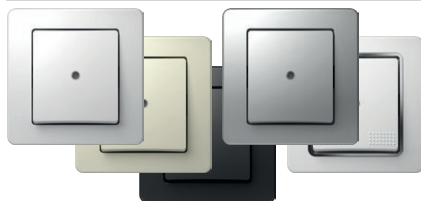

- SE10PWIN
- SE10IWIN
- SE10ESIN
- SE10COIN
- SE10NBIN

КЛЮЧ 1WAY 10AX 250V~ __ IN

- IN индикатор
- 10AX 250V~, тип SE10
- в съответствие с EN 60669-1
- контакти чрез вкарване 1,5 - 2,5 mm²

SWITCH 1WAY 10AX 250V~ __ IN
 - IN indicator
 - 10AX 250V~, type SE10
 - in accordance with EN 60669-1
 - plug-in contacts 1.5-2.5mm²



- SE11PW
- SE11IW
- SE11ES
- SE11CO
- SE11NB

БУТОН 1WAY 10A 250V~

- 10A 250V~, тип SE11
- в съответствие с EN 60669-1
- контакти чрез вкарване 1,5 - 2,5 mm²

PUSH BUTTON 1WAY 10A 250V~
 - 10A 250V~, type SE11
 - in accordance with EN 60669-1
 - plug-in contacts 1.5-2.5mm²



- SE11PWTI50
- SE11IWTI50
- SE11ESTI50
- SE11COTI50
- SE11NBTI50

БУТОН 1WAY 10A 250V~ __ TI 50

- TI 50 звънчев индикатор+неонова лампа
- 10A 250V~, тип SE11
- в съответствие с EN 60669-1
- контакти чрез вкарване 1,5 - 2,5 mm²

PUSH BUTTON 1WAY 10A 250V~ __ TI 50
 - TI 50 indicator bell+neon lamp
 - 10A 250V~, type SE11
 - in accordance with EN 60669-1
 - plug-in contacts 1.5-2.5mm²



- SE11PWTI51
- SE11IWTI51
- SE11ESTI51
- SE11COTI51
- SE11NBTI51

БУТОН 1WAY 10A 250V~ __ TI 51

- TI 51 светлинен индикатор+неонова лампа
- 10A 250V~, тип SE11
- в съответствие с EN 60669-1
- контакти чрез вкарване 1,5 - 2,5 mm²

PUSH BUTTON 1WAY 10A 250V~ __ TI 51
 - TI 51 indicator light+neon lamp
 - 10A 250V~, type SE11
 - in accordance with EN 60669-1
 - plug-in contacts 1.5-2.5mm²



- SE11PWIL
- SE11IWIL
- SE11ESIL
- SE11COIL
- SE11NBIL

БУТОН 1WAY 10A 250V~ __ IL

- IL панел с надпис
- 10A 250V~, тип SE11
- в съответствие с EN 60669-1
- контакти чрез вкарване 1,5 - 2,5 mm²

PUSH BUTTON 1WAY 10A 250V~ __ IL
 - IL inscription plate
 - 10A 250V~, type SE11
 - in accordance with EN 60669-1
 - plug-in contacts 1.5-2.5mm²



- SE22PWIN03
- SE22IWIN03
- SE22ESIN03
- SE22NBIN03

КЛЮЧ 2POLE 16AX 250V~ __ IN 03

- IN 03 неутрално положение 0-1
- 16AX 250V~, тип SE22
- в съответствие с EN 60669-1
- винтови контакти 1,5 - 2,5 mm²

SWITCH 2POLE 16AX 250V~ __ IN 03
 - IN 03 neutral 0-1
 - 16AX 250V~, type SE22
 - in accordance with EN 60669-1
 - screw contacts 1.5-2.5mm²



S W I T C H E S S E

	<ul style="list-style-type: none"> <input type="checkbox"/> SE50PW <input type="checkbox"/> SE50IW <input type="checkbox"/> SE50ES <input type="checkbox"/> SE50CO <input type="checkbox"/> SE50NB 	<p>КЛЮЧ 2GANG-1WAY 10AX 250V~</p> <ul style="list-style-type: none"> - 10AX 250V~, тип SE50 - в съответствие с EN 60669-1 - контакти чрез вкарване 1,5 - 2,5 mm² <p><i>SWITCH 2GANG-1WAY 10AX 250V~</i></p> <ul style="list-style-type: none"> - 10AX 250V~, type SE50 - in accordance with EN 60669-1 - plug-in contacts 1.5-2.5mm² 	
	<ul style="list-style-type: none"> <input type="checkbox"/> SE51PW <input type="checkbox"/> SE51IW <input type="checkbox"/> SE51ES <input type="checkbox"/> SE51CO <input type="checkbox"/> SE51NB 	<p>БУТОН 2GANG-1WAY 10A 250V~</p> <ul style="list-style-type: none"> - 10 A 250 V~, тип SE51 - в съответствие с EN 60669-1 - контакти чрез вкарване 1,5 - 2,5 mm² <p><i>PUSH BUTTON 2GANG-1WAY 10A 250V~</i></p> <ul style="list-style-type: none"> - 10A 250V~, type SE51 - in accordance with EN 60669-1 - plug-in contacts 1.5-2.5mm² 	
	<ul style="list-style-type: none"> <input type="checkbox"/> SE52PWNT09 <input type="checkbox"/> SE52IWNT09 <input type="checkbox"/> SE52ESNT09 <input type="checkbox"/> SE52CONT09 <input type="checkbox"/> SE52NBNT09 	<p>КЛЮЧ ЗА ЩОРИ 10AX 250V~ __ NT 09</p> <ul style="list-style-type: none"> - NT 09 неутрално положение – нагоре-надолу - 10AX 250 V~, тип SE52 - в съответствие с EN 60669-1 - контакти чрез вкарване 1,5 - 2,5 mm² - с механична блокировка <p><i>SWITCH SHUTTERS 10AX 250V~ __ NT 09</i></p> <ul style="list-style-type: none"> - NT 09 neutral up-down - 10AX 250V~, type SE52 - in accordance with EN 60669-1 - plug-in contacts 1.5-2.5mm² - with mechanical interblock 	
	<ul style="list-style-type: none"> <input type="checkbox"/> SE53PWNT09 <input type="checkbox"/> SE53IWNT09 <input type="checkbox"/> SE53ESNT09 <input type="checkbox"/> SE53CONT09 <input type="checkbox"/> SE53NBNT09 	<p>БУТОНИ ЗА ЩОРИ 10A 250V~ __ NT 09</p> <ul style="list-style-type: none"> - NT 09 неутрално положение – нагоре-надолу - 10 A 250 V~, тип SE53 - в съответствие с EN 60669-1 - контакти чрез вкарване 1,5 - 2,5 mm² - с механична блокировка <p><i>PUSH BUTTON SHUTTERS 10A 250V~ __ NT 09</i></p> <ul style="list-style-type: none"> - NT 09 neutral up-down - 10A 250V~, type SE53 - in accordance with EN 60669-1 - plug-in contacts 1.5-2.5mm² - with mechanical interblock 	
	<ul style="list-style-type: none"> <input type="checkbox"/> SE60PW <input type="checkbox"/> SE60IW <input type="checkbox"/> SE60ES <input type="checkbox"/> SE60CO <input type="checkbox"/> SE60NB 	<p>КЛЮЧ 2WAY 10AX 250V~</p> <ul style="list-style-type: none"> - 10AX 250V~, тип SE60 - в съответствие с EN 60669-1 - контакти чрез вкарване 1,5 - 2,5 mm² <p><i>SWITCH 2WAY 10AX 250V~</i></p> <ul style="list-style-type: none"> - 10AX 250V~, type SE60 - in accordance with EN 60669-1 - plug-in contacts 1.5-2.5mm² 	
	<ul style="list-style-type: none"> <input type="checkbox"/> SE63PW <input type="checkbox"/> SE63IW <input type="checkbox"/> SE63ES <input type="checkbox"/> SE63CO <input type="checkbox"/> SE63NB 	<p>ДВОЕН КЛЮЧ 2WAY 10AX 250V~</p> <ul style="list-style-type: none"> - 10AX 250V~, тип SE63 - в съответствие с EN 60669-1 - контакти чрез вкарване 1,5 - 2,5 mm² <p><i>SWITCH DOUBLE 2WAY 10AX 250V~</i></p> <ul style="list-style-type: none"> - 10AX 250V~, type SE63 - in accordance with EN 60669-1 - plug-in contacts 1.5-2.5mm² 	
	<ul style="list-style-type: none"> <input type="checkbox"/> SE70PW <input type="checkbox"/> SE70IW <input type="checkbox"/> SE70ES <input type="checkbox"/> SE70CO <input type="checkbox"/> SE70NB 	<p>КРЪСТАТ КЛЮЧ 10AX 250V~</p> <ul style="list-style-type: none"> - 10AX 250V~, тип SE70 - в съответствие с EN 60669-1 - контакти чрез вкарване 1,5 - 2,5 mm² <p><i>SWITCH INTERMEDIATE 10AX 250V~</i></p> <ul style="list-style-type: none"> - 10AX 250V~, type SE70 - in accordance with EN 60669-1 - plug-in contacts 1.5-2.5mm² 	

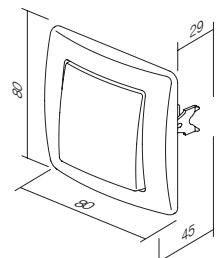
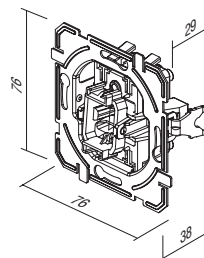

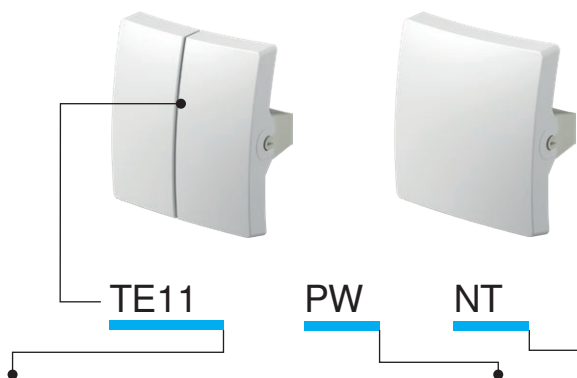

тип type	описание description	цвет colour	допълнителна информация 1 optional data 1	допълнителна информация 2 optional data 2
TE10	БУТОН 1GANG BUTTON 1GANG	<input type="checkbox"/> PW снежнобял цвет polar white	NT с неутрално положение neutral	50
TE11	БУТОН 2GANG BUTTON 2GANG	<input type="checkbox"/> IW слонова кост ivory white	IN индикатор indicator	51
...	...	<input type="checkbox"/> ES сребрист elox silver		03
...	...	<input type="checkbox"/> CO бял с термореактивен материал white thermoset		04
...	...	<input type="checkbox"/> NB тъмночерен night black		

БУТОН 1GANG



- TE10PW
- TE10IW
- TE10ES
- TE10CO
- TE10NB

- бутон заедно с носач
BUTTON 1GANG
- button together with carrier



БУТОН С ИНДИКАТОР

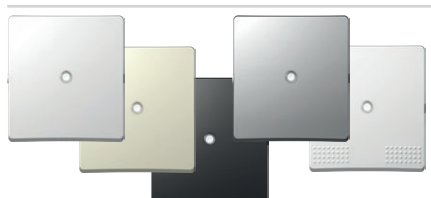

- TE10PWIN
- TE10IWIN
- TE10ESIN
- TE10COIN
- TE10NBIN

- бутон заедно с носач
BUTTON INDICATOR
- button together with carrier



БУТОН С ПАНЕЛ С НАДПИС

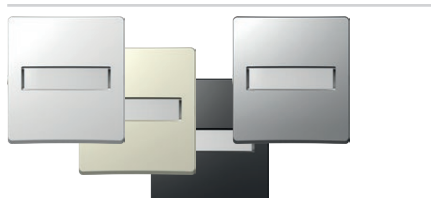

- TE13PWIL
- TE13IWIL
- TE13ESIL
- TE13NBIL

- бутон заедно с носач, с панел с надпис
BUTTON WITH INSCRIPTION PLATE
- button together with carrier, with inscription plate



БУТОН 2GANG



- TE11PW
- TE11IW
- TE11ES
- TE11CO
- TE11NB

- бутон 2gang с носач
BUTTON 2GANG
- button 2gang together with carrier

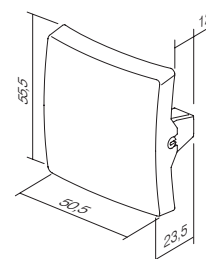
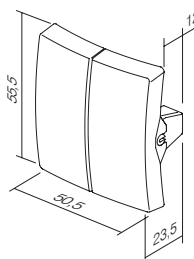

S I G N A L I Z A T I O N I A

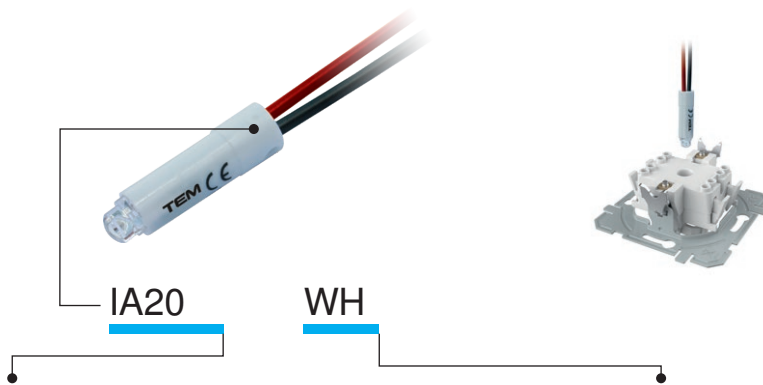

тип type	описание description	технически данни technical data	цвет colour
IA10	НЕОНОВА ЛАМПА NEON LAMP	230V~ 0,34W	<input type="checkbox"/> WH бял цвят white
IA20	СВЕТОДИОДНА СИГНАЛИЗАЦИЯ LED SIGNALLING UNIT	230V~ 0,40W	<input checked="" type="checkbox"/> BL син цвят blue
IA21	СВЕТОДИОДНА СИГНАЛИЗАЦИЯ LED SIGNALLING UNIT	24V AC/DC 0,20W	<input checked="" type="checkbox"/> RD червен red
·	·	·	<input checked="" type="checkbox"/> GR зелен green
·	·	·	<input checked="" type="checkbox"/> OR оранжев orange

НЕОНОВА ЛАМПА 230 V~ 0,34 W



 IA10OR

- за индикиране, сигнализация или постоянна сигнализация;
- в съчетание с бутон с индикатор

NEON LAMP 230V~ 0,34W

- for indication, signalling or permanent signalling
- in combination with a button featuring an indicator

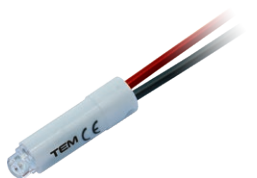
СВЕТОДИОДНА СИГНАЛИЗАЦИЯ 230 V AC/DC 0,40 W



 IA20WH
 IA20GR
 IA20RD
 IA20BL

- за индикиране, сигнализация или постоянна сигнализация;
- в съчетание с бутон с индикатор

LED SIGNALLING UNIT 230V AC/DC 0,40W

- for indication, signalling or permanent signalling
- in combination with a button featuring an indicator

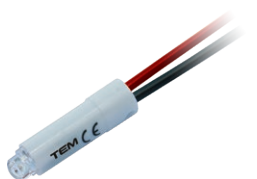
СВЕТОДИОДНА СИГНАЛИЗАЦИЯ 24V AC/DC 0,20W



 IA21WH
 IA21RD

- за индикиране, сигнализация или постоянна сигнализация;
- в съчетание с бутон с индикатор

LED SIGNALLING UNIT 24V AC/DC 0,20W

- for indication, signalling or permanent signalling
- in combination with a button featuring an indicator

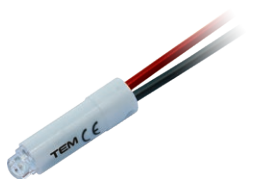
СВЕТОДИОДНА СИГНАЛИЗАЦИЯ 12V AC/DC 0,10W

 IA22WH
 IA22RD

- за индикиране, сигнализация или постоянна сигнализация;
- в съчетание с бутон с индикатор

LED SIGNALLING UNIT 12V AC/DC 0,10W

- for indication, signalling or permanent signalling
- in combination with a button featuring an indicator

Индикация /
Indication

* Сигнализация /
Signalization

Постоянна сигнализация /
Permanent signalling

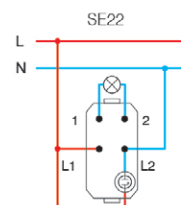
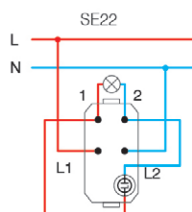
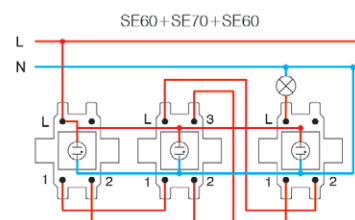
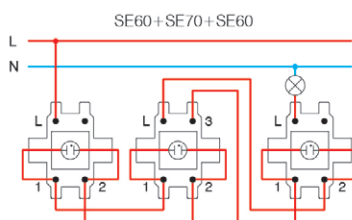
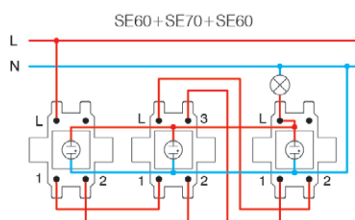
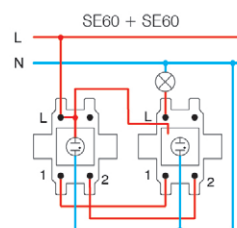
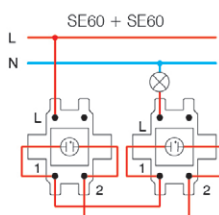
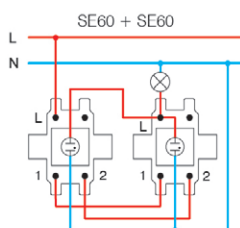
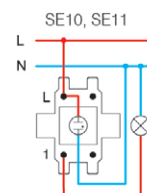
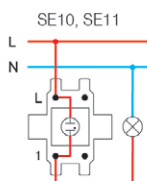
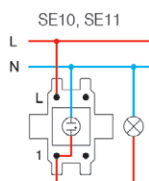

* връзките не са подходящи за енергоспестяващи крушки (CFL, LED) /
the connections are not suitable for energy-saving bulbs (CFL, LED)

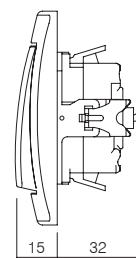

S O C K E T S V E



VE11



PT

XO

KS



тип type	описание description	технически данни technical data	допълнителна информация 1 optional data 1	допълнителна информация 2 optional data 2
VE10	КОНТАКТ ШУКО SOCKET SCHUKO	2P+E 16A 250V~	XO без декоративен панел without cover plate	KS Вградена защита от допир на контакти shuttered live contacts
VE11	КОНТАКТ ШУКО+КАПАК SOCKET SCHUKO+COVER	2P+E 16A 250V~		
VE12	КОНТАКТ ШУКО SOCKET SCHUKO	2P+E 16A 250V~ BV	KS Вградена защита от допир на контакти shuttered live contacts	
⋮	⋮	⋮		

ЦВЯТ
colour

<input type="checkbox"/> PW снежнобял цвят polar white	<input checked="" type="checkbox"/> PT бял + прозрачен white+transparent	<input type="checkbox"/> PP бял + бял white+white
<input checked="" type="checkbox"/> IW слонова кост ivory white	<input checked="" type="checkbox"/> IT слонова кост + прозрачен ivory+transparent	<input checked="" type="checkbox"/> II слонова кост + слонова кост ivory+ivory
<input type="checkbox"/> ES сребрист elox silver	<input checked="" type="checkbox"/> ST сребрист + прозрачен silver+transparent	<input type="checkbox"/> SS сребрист + сребрист silver+silver
<input type="checkbox"/> CO бял с термореактивен материал white thermoset	<input type="checkbox"/> CT бял + прозрачен white+transparent	<input type="checkbox"/> BB черен + черен black+black
<input checked="" type="checkbox"/> NB тъмночерен night black	<input checked="" type="checkbox"/> BT черен + прозрачен black+transparent	<input type="checkbox"/> RR червен + червен red+red
<input checked="" type="checkbox"/> RD червен red	<input checked="" type="checkbox"/> RT червен + прозрачен red+transparent	<input type="checkbox"/> GG зелен + зелен green+green
<input checked="" type="checkbox"/> GR зелен green	<input checked="" type="checkbox"/> GT зелен + прозрачен green+transparent	<input type="checkbox"/> OO оранжев + оранжев orange+orange
<input checked="" type="checkbox"/> OR оранжев orange	<input checked="" type="checkbox"/> OT оранжев + прозрачен orange+transparent	



Шуко – в съответствие с EN 60884-1, CEE7 (лист със стандарти III)

Френски – в съответствие с NF C 61-314 (лист със стандарти V)

shuko - in accordance with EN 60884-1, CEE7 (standard sheet III)

French - in accordance with NF C 61-314 (standard sheet V)

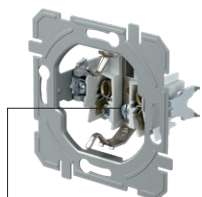
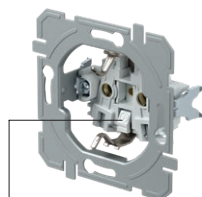
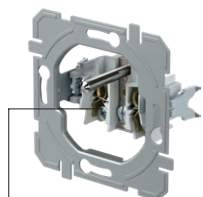
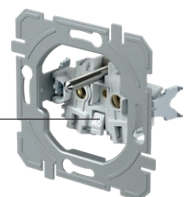
винтови контакти
screw contactsBV контакти чрез вкарване
BV plug-in contactsвинтови контакти
screw contactsBV контакти чрез вкарване
BV plug-in contacts

КОНТАКТ ШУКО 2P+E 16A 250V~ __ XO

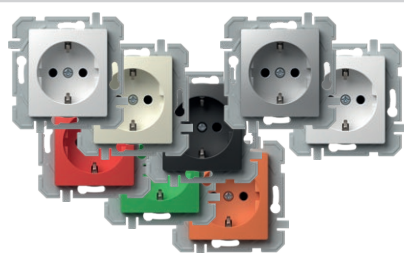

- VE10PWXO
- VE10IWXO
- VE10ESXO
- VE10COXO
- VE10NBXO
- VE10RDXO
- VE10GRXO
- VE10ORXO

- винтови контакти 1,5 - 2,5 mm²
- XO без панел
- 2P+E шуко
- 16A 250V~, тип VE10

SOCKET SCHUKO 2P+E 16A 250V~ __ XO

- screw contacts 1.5-2.5mm²
- XO without surround
- 2P+E schuko
- 16A 250V~, type VE10



КОНТАКТ ШУКО+КАПАК 2P+E 16 A 250 V~ __ XO

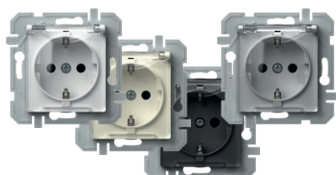

- VE11PTXO
- VE11ITXO
- VE11STXO
- VE11BTXO

- винтови контакти 1,5 - 2,5 mm²
- XO без рамка
- 2P+E шуко+капак
- 16 A 250 V~, тип VE11

SOCKET SCHUKO+COVER 2P+E 16A 250V~ __ XO

- screw contacts 1.5-2.5mm²
- XO without surround
- 2P+E schuko+cover
- 16A 250V~, type VE11



КОНТАКТ ШУКО 2P+E 16A 250V~ BV __ XO

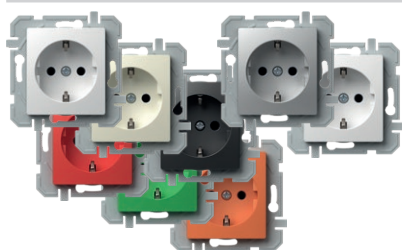

- VE12PWXO
- VE12IWXO
- VE12ESXO
- VE12COXO
- VE12NBXO
- VE12RDXO
- VE12GRXO
- VE12ORXO

- BV контакти чрез вкарване 1,5 - 2,5 mm²
- XO без панел
- 2P+E шуко
- 16A 250V~, тип VE12

SOCKET SCHUKO 2P+E 16A 250V~ BV __ XO

- BV plug-in contacts 1.5-2.5mm²
- XO without surround
- 2P+E schuko
- 16A 250V~, type VE12



КОНТАКТ ШУКО+КАПАК 2P+E 16A 250V~ BV __ XO

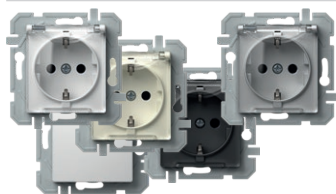

- VE13PTXO
- VE13ITXO
- VE13STXO
- VE13BTXO
- VE13PPXO

- BV контакти чрез вкарване 1,5 - 2,5 mm²
- XO без панел
- 2P+E шуко+капак
- 16A 250V~, тип VE13

SOCKET SCHUKO+COVER 2P+E 16A 250V~ BV __ XO

- BV plug-in contacts 1.5-2.5mm²
- XO without surround
- 2P+E schuko+cover
- 16A 250V~, type VE13



КОНТАКТ ШУКО 2P+E 16A 250V~



- VE10PW
- VE10IW
- VE10ES
- VE10CO
- VE10NB

- винтови контакти 1,5 - 2,5 mm²
- 2P+E шуко
- 16A 250V~, тип VE10

SOCKET SCHUKO 2P+E 16A 250V~

- screw contacts 1.5-2.5mm²
- 2P+E schuko
- 16A 250V~, type VE10



КОНТАКТ ШУКО+КАПАК 2P+E 16A 250V~



- VE11PT
- VE11IT
- VE11ST
- VE11CT
- VE11BT

- винтови контакти 1,5 - 2,5 mm²
- 2P+E шуко+капак
- 16A 250V~, тип VE11

SOCKET SCHUKO+COVER 2P+E 16A 250V~

- screw contacts 1.5-2.5mm²
- 2P+E schuko+cover
- 16A 250V~, type VE11



КОНТАКТ ШУКО 2P+E 16A 250V~ BV



- VE12PW
- VE12IW
- VE12ES
- VE12CO
- VE12NB

- BV контакти чрез вкарване 1,5 - 2,5 mm²
- 2P+E шуко
- 16A 250V~, тип VE12

SOCKET SCHUKO 2P+E 16A 250V~ BV

- BV plug-in contacts 1.5-2.5mm²
- 2P+E schuko
- 16A 250V~, type VE12



КОНТАКТ ШУКО+КАПАК 2P+E 16A 250V~ BV



- VE13PT
- VE13IT
- VE13ST
- VE13CT
- VE13BT

- BV контакти чрез вкарване 1,5 - 2,5 mm²
- 2P+E шуко+капак
- 16A 250V~, тип VE13

SOCKET SCHUKO+COVER 2P+E 16A 250V~ BV

- BV plug-in contacts 1.5-2.5mm²
- 2P+E schuko+cover
- 16A 250V~, type VE13

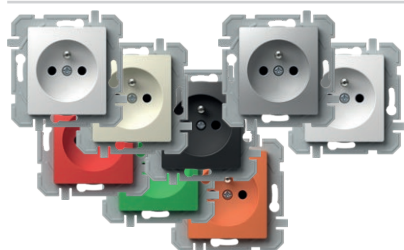

КОНТАКТ ФРЕНСКИ 2P+E 16A 250V~ __ XO

- VE40PWXO - винтови контакти 1,5 - 2,5 mm²
- VE40IWXO - XO без панел
- VE40ESXO - 2P+E френски контакт
- VE40COXO - 16A 250V~, тип VE40
- VE40NBXO
- VE40RDXO
- VE40GRXO
- VE40ORXO

SOCKET FRENCH 2P+E 16A 250V~ __ XO

- screw contacts 1.5-2.5mm²
- XO without surround
- 2P+E French
- 16A 250V~, type VE40

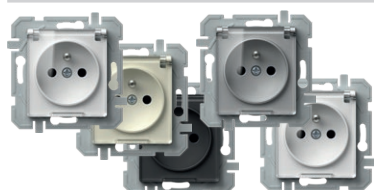
КОНТАКТ ФРЕНСКИ+КАПАК 2P+E 16A 250V~ __ XO

- VE41PTXO - винтови контакти 1,5 - 2,5 mm²
- VE41ITXO - XO без панел
- VE41STXO - 2P+E френски контакт+капак
- VE41BTXO - 16A 250V~, тип VE41

SOCKET FRENCH+COVER 2P+E 16A 250V~ __ XO

- screw contacts 1.5-2.5mm²
- XO without surround
- 2P+E French+cover
- 16A 250V~, type VE41

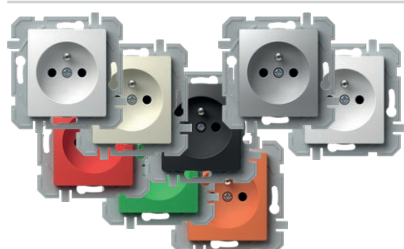
КОНТАКТ ФРЕНСКИ 2P+E 16A 250V~ BV __ XO

- VE42PWXO - BV контакти чрез вкарване 1,5 - 2,5 mm²
- VE42IWXO - XO без панел
- VE42ESXO - 2P+E френски контакт
- VE42COXO - 16A 250V~, тип VE42
- VE42NBXO
- VE42RDXO
- VE42GRXO
- VE42ORXO

SOCKET FRENCH 2P+E 16A 250V~ BV __ XO

- BV plug-in contacts 1.5-2.5mm²
- XO without surround
- 2P+E French
- 16A 250V~, type VE42

КОНТАКТ ФРЕНСКИ+КАПАК 2P+E 16 A 250 V~ BV __ XO

- VE43PTXO - BV контакти чрез вкарване 1,5 - 2,5 mm²
- VE43ITXO - XO без рамка
- VE43STXO - 2P+E френски контакт+капак
- VE43BTXO - 16 A 250 V~, тип VE43

SOCKET FRENCH+COVER 2P+E 16A 250V~ BV __ XO

- BV plug-in contacts 1.5-2.5mm²
- XO without surround
- 2P+E French+cover
- 16A 250V~, type VE43

КОНТАКТ ФРЕНСКИ 2P+E 16A 250V~

- VE40PW - винтови контакти 1,5 - 2,5 mm²
- VE40IW - 2P+E френски контакт
- VE40ES - 16A 250V~, тип VE40
- VE40CO
- VE40NB

SOCKET FRENCH 2P+E 16A 250V~

- screw contacts 1.5-2.5mm²
- 2P+E French
- 16A 250V~, type VE40

КОНТАКТ ФРЕНСКИ+КАПАК 2P+E 16A 250V~

- VE41PT - винтови контакти 1,5 - 2,5 mm²
- VE41IT - 2P+E френски контакт+капак
- VE41BT - 16A 250V~, тип VE41
- VE41ST

SOCKET FRENCH+COVER 2P+E 16A 250V~

- screw contacts 1.5-2.5mm²
- 2P+E French+cover
- 16A 250V~, type VE41

КОНТАКТ ФРЕНСКИ 2P+E 16A 250V~ BV

- VE42PW - BV контакти чрез вкарване 1,5 - 2,5 mm²
- VE42IW - 2P+E френски контакт
- VE42ES - 16A 250V~, тип VE42
- VE42CO
- VE42NB

SOCKET FRENCH 2P+E 16A 250V~ BV

- BV plug-in contacts 1.5-2.5mm²
- 2P+E French
- 16A 250V~, type VE42

КОНТАКТ ФРЕНСКИ+КАПАК 2P+E 16A 250V~ BV

- VE43PT - BV контакти чрез вкарване 1,5 - 2,5 mm²
- VE43IT - 2P+E френски контакт+капак
- VE43BT - 16A 250V~, тип VE43
- VE43ST

SOCKET FRENCH+COVER 2P+E 16A 250V~ BV

- BV plug-in contacts 1.5-2.5mm²
- 2P+E French+cover
- 16A 250V~, type VE43



КОНТАКТ ШУКО DOUBLE 2P+E 16A 250V~



- VE16PWKS
- VE16IWKS
- VE16ESKS
- VE16NBKS

- 2P+E шуко двоен, 16A 250V~, тип VE16
 - в съответствие с IEC 60884-1, CEE7
 - винтови контакти 1,5 - 2,5 mm²
 - Вградена защита от допир на контакти

SOCKET SCHUKO DOUBLE 2P+E 16A 250V~

- 2P+E schuko double
 - 16A 250V~, type VE16
 - in accordance with IEC 60884-1, CEE7
 - screw contacts 1.5-2.5 mm²
 - shuttered live contacts



КОНТАКТ ФРЕНСКИ ДВОЕН 2P+E 16A 250V~



- VE46PWKS
- VE46IWKS
- VE46ESKS
- VE46NBKS

- 2P+E френски двоен, 16A 250V~, тип VE46
 - в съответствие с IEC 60884-1, CEE7; NF C 61-314, CSN 33 2318; PN-E 93201
 - винтови контакти 1,5 - 2,5 mm²
 - Вградена защита от допир на контакти

SOCKET FRENCH DOUBLE 2P+E 16A 250V~

- 2P+E French double
 - 16A 250V~, type VE46
 - in accordance with IEC 60884-1, CEE7; NF C 61-314, CSN 33 2318; PN-E 93201
 - screw contacts 1,5-2,5 mm²
 - shuttered live contacts



КОНТАКТ 2P 16A 250V~

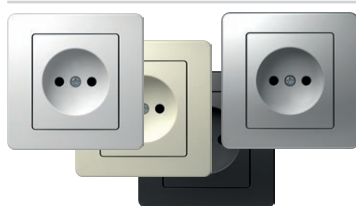

- VE30PW
- VE30IW
- VE30ES
- VE30NB

- 2P без контакт за заземяване
 - 16A 250V~
 - в съответствие с EN 60884-1, CEE7 (лист със стандарти I)
 - винтови контакти 1,5 - 2,5 mm²

SOCKET 2P 16A 250V~

- 2P without earthing contact
 - 16A 250V~
 - in accordance with EN 60884-1, CEE7 (standard sheet I)
 - screw contacts 1.5-2.5mm²

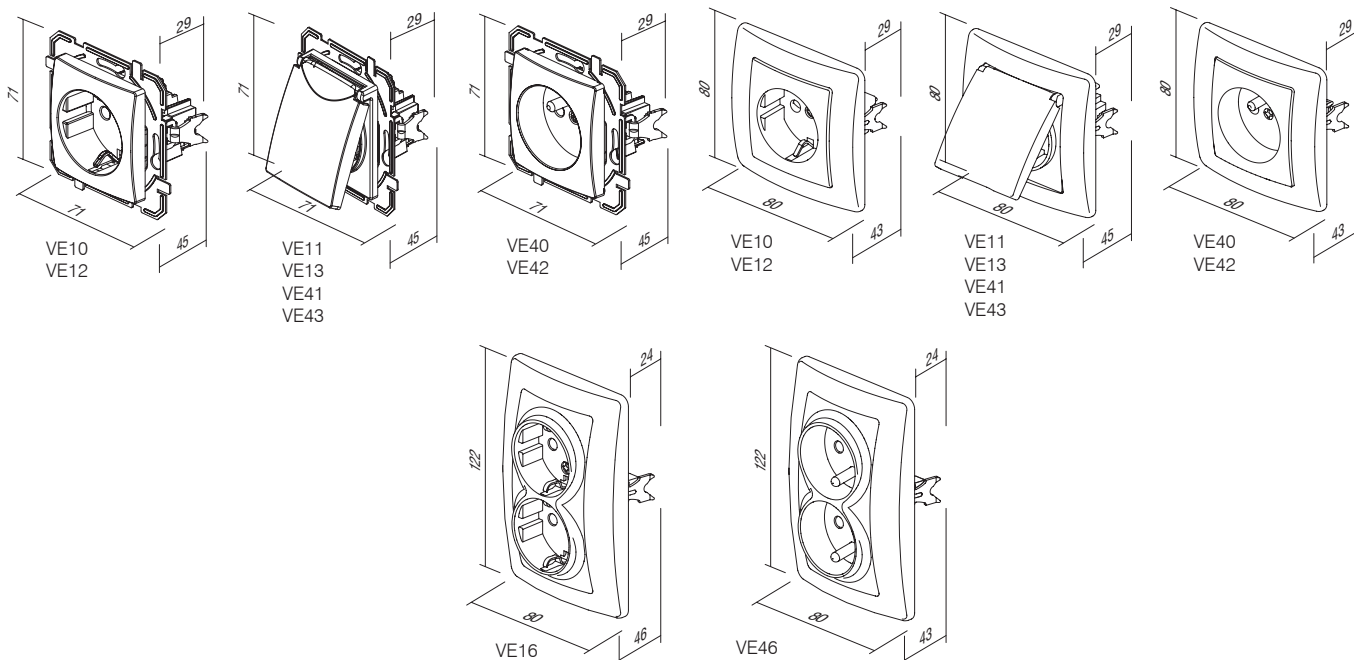



KE37

PW

тип type	описание description	технически данни technical data	цвет colour
KE11	КОНЕКТОР ЗА ТВ-РАДИО КРАЕН SOCKET TV-R END-LINE	1dB	<input type="checkbox"/> PW снежнобял цвят polar white
KE12	КОНЕКТОР ЗА ТВ-РАДИО ПРЕХОДЕН SOCKET TV-R THROUGHPASS	10dB	<input type="checkbox"/> IW слонова кост ivory white
KE16	КОНЕКТОР ЗА СATEЛИТНА ТВ-РАДИО КРАЕН SOCKET SAT-TV-R END-LINE	3dB	<input type="checkbox"/> ES сребрист цвят с анодизирано покритие elox silver
⋮	⋮	⋮	<input type="checkbox"/> CO бял с термореактивен материал white thermoset
⋮	⋮	⋮	<input type="checkbox"/> NB тъмночерен night black

КОНЕКТОР ЗА ТВ-РАДИО КРАЕН 1 dB



KE11

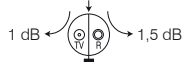

- за ТВ-радио краен
- честотен обхват 5÷862 MHz
- затихване: Радио-1,5 dB, ТВ-1 dB
- в съответствие с EN 50083-1
- винтови контакти

SOCKET TV-R END-LINE 1dB

- TV-R end-line
- frequency range 5÷862MHz
- reduction: R-1.5dB, TV-1dB
- in accordance with EN 50083-1
- screw contacts

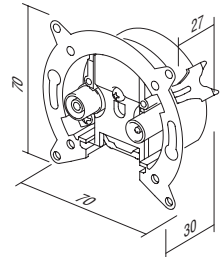

КОНЕКТОР ЗА ТВ-РАДИО ПРЕХОДЕН 10 dB



KE12

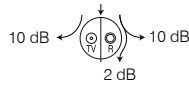

- преходник за ТВ-радио
- честотен обхват 5÷862 MHz
- затихване: Радио-10 dB, ТВ-10 dB, преход-2 dB
- в съответствие с EN 50083-1
- винтови контакти

SOCKET TV-R TROUGHPASS 10dB

- TV-R troughpass
- frequency range 5÷862MHz
- reduction: R-10dB, TV-10dB, trough-2dB
- in accordance with EN 50083-1
- screw contacts

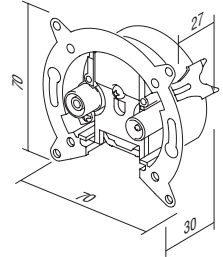

КОНЕКТОР ЗА СATEЛИТНА ТВ-ТВ-РАДИО КРАЕН 3 dB



KE16

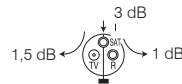

- за сателитна ТВ-ТВ-радио краен
- честотен обхват 5÷2400 MHz
- затихване: Радио-1dB, ТВ-1,5dB, сателитна ТВ-3 dB
- за монтаж в кръгла конзола Ø60 с крачета или винтове
- в съответствие с EN 50083-1
- винтови контакти

SOCKET SAT-TV-R END-LINE 3dB

- SAT-TV-R end-line
- frequency range 5÷2400MHz
- reduction: R-1dB, TV-1.5dB, SAT-3dB
- for mounting in round box Ø60 with claws or screws
- in accordance with EN 50083-1
- screw contacts

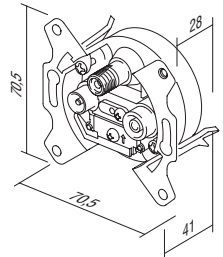

КОНЕКТОР ЗА ТЕЛЕФОН KS RJ11 6/4

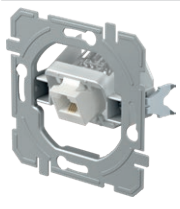

KE36

- KS модул стандарт за закрепване
- RJ11 6/4
- в съответствие с IEC 60603-7

SOCKET TEL KS RJ11 6/4

- KS keystone fixing standard
- RJ11 6/4
- in accordance with IEC 60603-7

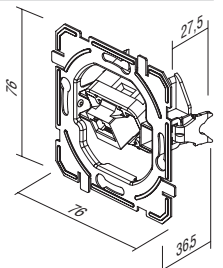

КОНЕКТОР CAT5e KS RJ45 8/8

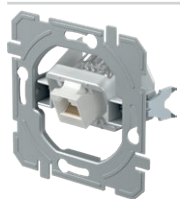

KE37

- KS модулен стандарт за закрепване
- CAT5e, RJ45 8/8
- в съответствие с IEC 60603-7

SOCKET CAT5e KS RJ45 8/8
 - KS keystone fixing standard
 - CAT5e, RJ45 8/8
 - in accordance with IEC 60603-7

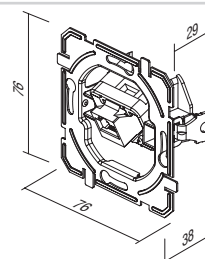

КОНЕКТОР CAT6s KS RJ45 8/8 SLIM

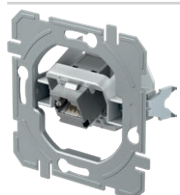

KE40

- KS модулен стандарт за закрепване
- CAT6s, RJ45 8/8
- в съответствие с IEC 60603-7

SOCKET CAT6s KS RJ45 8/8 SLIM
 - KS keystone fixing standard
 - CAT6s, RJ45 8/8
 - in accordance with IEC 60603-7

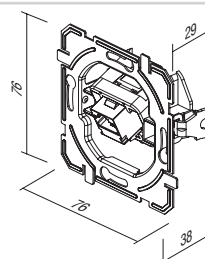

КОНЕКТОР ЗА ТЕЛЕФОН KS 2x RJ11 6/4

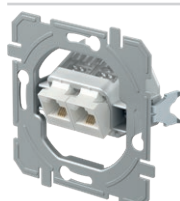

KE38

- KS модулен стандарт за закрепване
- 2 x RJ11 6/4
- в съответствие с IEC 60603-7

SOCKET TEL KS DOUBLE 2x RJ11 6/4
 - KS keystone fixing standard
 - 2x RJ11 6/4
 - in accordance with IEC 60603-7

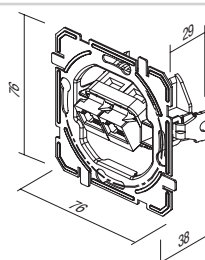

ДВОЕН КОНЕКТОР CAT5e KS 2x RJ45 8/8

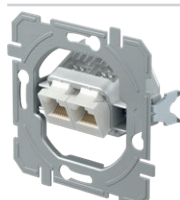

KE39

- KS модулен стандарт за закрепване
- 2 x CAT5e, RJ45 8/8
- в съответствие с IEC 60603-7

SOCKET CAT5e KS DOUBLE 2x RJ45 8/8
 - KS keystone fixing standard
 - 2x CAT5e, RJ45 8/8
 - in accordance with IEC 60603-7

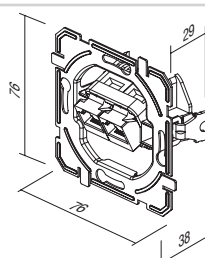

ДВОЕН КОНЕКТОР CAT6s KS 2x RJ45 8/8 SLIM



KE41

- KS модулен стандарт за закрепване
- 2 x CAT6s, RJ45 8/8
- в съответствие с IEC 60603-7

SOCKET CAT6s KS DOUBLE 2x RJ45 8/8 SLIM
 - KS keystone fixing standard
 - 2x CAT6s, RJ45 8/8
 - in accordance with IEC 60603-7

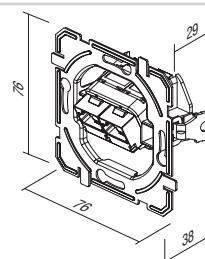

АДАПТЕР KS ЕДИНИЧЕН

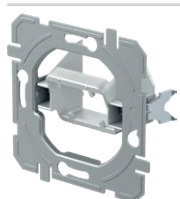

KE45

- KS модулен стандарт за закрепване – единичен
- AMP, Avaya, Brandrex, FMT, Mfico, Tyco, ...
- комуникационният модул не е включен в доставката

ADAPTER KS SINGLE
 - KS keystone fixing standard - single
 - AMP, Avaya, Brandrex, FMT, Mfico, Tyco, ...
 - communication module not included

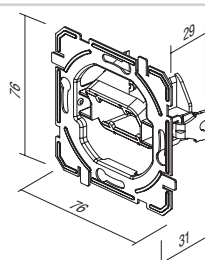

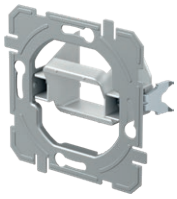

KE46

АДАПТЕР KS ДВОЕН

- KS модулен стандарт за закрепване – двоен
- AMP, Tyco, ...
- комуникационният модул не е включен в доставката

ADAPTER KS DOUBLE

- KS keystone fixing standard - double
- AMP, Tyco, ...
- communication module not included

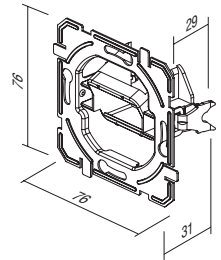

KE47

АДАПТЕР PD ДВОЕН

- стандарт за закрепване PD Panduit Mini-COM – двоен
- комуникационният модул не е включен в доставката

ADAPTER PD DOUBLE

- PD Panduit Mini-COM fixing standard - double
- communication module not included

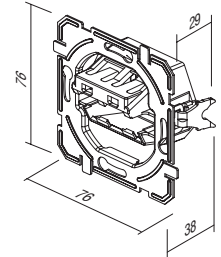

КОНЕКТОР ЗА ТВ ОСНОВЕН 0 dB



- KE10PW
- KE10IW
- KE10ES
- KE10CO
- KE10NB

- контакт за ТВ базов
- затихване 0 dB
- заден конектор – стандарт F

SOCKET TV BASIC 0dB

- TV basic
- reduction 0dB
- back connector – F standard



КОНЕКТОР ЗА ТВ-РАДИО КРАЕН 1 dB



- KE11PW
- KE11IW
- KE11ES
- KE11CO
- KE11NB

- за ТВ-радио краен
- честотен обхват 5÷862 MHz
- затихване: Радио-1.5 dB, ТВ-1 dB
- в съответствие с EN 50083-1
- винтови контакти

SOCKET TV-R END-LINE 1dB

- TV-R end-line
- frequency range 5÷862 MHz
- reduction: R-1.5dB, TV-1dB
- in accordance with EN 50083-1
- screw contact



КОНЕКТОР ЗА ТВ-РАДИО ПРЕХОДЕН 10 dB



- KE12PW
- KE12IW
- KE12ES
- KE12CO
- KE12NB

- преходник за ТВ-радио
- честотен обхват 5÷862 MHz
- затихване: Радио-10 dB, ТВ-10 dB, преход-2 dB
- в съответствие с EN 50083-1
- винтови контакти

SOCKET TV-R TROUGH-PASS 10dB

- TV-R troughpass
- frequency range 5÷862 MHz
- reduction: R-10dB, TV-10dB, trough-2dB
- in accordance with EN 50083-1
- screw contacts



КОНЕКТОР ЗА САТЕЛИТНА ТВ-ТВ-РАДИО КРАЕН 3 dB



- KE16PW
- KE16IW
- KE16ES
- KE16CO
- KE16NB

- за сателитна ТВ-ТВ-радио краен
- честотен обхват 5÷2400 MHz
- затихване: Радио-1dB, ТВ-1.5dB, сателитна ТВ-3 dB
- в съответствие с EN 50083-1
- винтови контакти

SOCKET SAT-TV-R END-LINE 3dB

- SAT-TV-R end-line
- frequency range 5÷2400 MHz
- reduction: R-1dB, TV-1.5dB, SAT-3dB
- in accordance with EN 50083-1
- screw contacts



КОНЕКТОР ЗА АУДИОСИГНАЛИ 2xRCA



- KE22PW
- KE22IW
- KE22ES
- KE22CO
- KE22NB

- за аудиосигнали, 2xRCA
- свързване на кабела чрез запояване

SOCKET AUDIO 2xRCA

- audio 2xRCA
- soldering connection of cable



КОНЕКТОР ЗА ВИСОКОГОВОРТЕЛИ



- KE23PW
- KE23IW
- KE23ES
- KE23CO
- KE23NB

- за аудиосигнали, 2x Ø4 mm
- за проводник за високоговорители, с щепсел тип банан Ø4 mm или плоски конектори
- свързване на кабела от задната страна чрез запояване

SOCKET AUDIO LOUDSPEAKERS

- audio 2x Ø4mm
- to accommodate speaker wire, banana plug Ø4mm or spades
- soldering connection of cable at the back side



КОНЕКТОР ЗА ТЕЛЕФОН KS RJ11 6/4

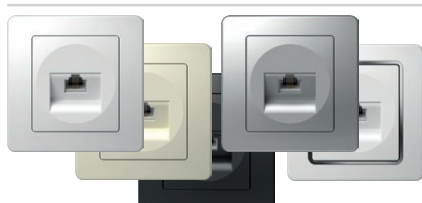

- KE36PW
- KE36IW
- KE36ES
- KE36CO
- KE36NB

- KS модул стандарт за закрепване
- RJ11 6/4
- в съответствие с IEC 60603-7

SOCKET TEL KS RJ11 6/4

- KS keystone fixing standard
- RJ11 6/4
- in accordance with IEC 60603-7





- KE37PW
- KE37IW
- KE37ES
- KE37CO
- KE37NB

КОНЕКТОР CAT5e KS RJ45 8/8

- KS модулен стандарт за закрепване
- CAT5e, RJ45 8/8
- в съответствие с IEC 60603-7

SOCKET CAT5e KS RJ45 8/8

- KS keystone fixing standard
- CAT5e, RJ45 8/8
- in accordance with IEC 60603-7



- KE40PW
- KE40IW
- KE40ES
- KE40CO
- KE40NB

КОНЕКТОР CAT6s KS RJ45 8/8 SLIM

- KS модулен стандарт за закрепване
- CAT6s, RJ45 8/8
- в съответствие с IEC 60603-7

SOCKET CAT6s KS RJ45 8/8 SLIM

- KS keystone fixing standard
- CAT6s, RJ45 8/8
- in accordance with IEC 60603-7

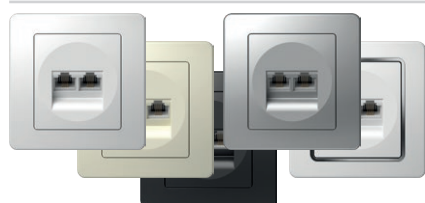

- KE38PW
- KE38IW
- KE38ES
- KE38CO
- KE38NB

КОНЕКТОР ЗА ТЕЛЕФОН KS 2x RJ11 6/4

- KS модулен стандарт за закрепване
- 2x RJ11, 6/4
- в съответствие с IEC 60603-7

SOCKET TEL KS DOUBLE 2x RJ11 6/4

- KS keystone fixing standard
- 2x RJ11, 6/4
- in accordance with IEC 60603-7



- KE39PW
- KE39IW
- KE39ES
- KE39CO
- KE39NB

ДВОЕН КОНЕКТОР CAT5e KS 2x RJ45 8/8

- KS модулен стандарт за закрепване
- 2 x CAT5e, RJ45 8/8
- в съответствие с IEC 60603-7

SOCKET CAT5e KS DOUBLE 2x RJ45 8/8

- KS keystone fixing standard
- 2x CAT5e, RJ45 8/8
- in accordance with IEC 60603-7



- KE41PW
- KE41IW
- KE41ES
- KE41CO
- KE41NB

ДВОЕН КОНЕКТОР CAT6s KS 2x RJ45 8/8 SLIM

- KS модулен стандарт за закрепване
- 2 x CAT6s, RJ45 8/8
- в съответствие с IEC 60603-7

SOCKET CAT6s KS DOUBLE 2x RJ45 8/8 SLIM

- KS keystone fixing standard
- 2x CAT6s, RJ45 8/8
- in accordance with IEC 60603-7



- KE35PW
- KE35IW
- KE35ES
- KE35CO
- KE35NB

КОНЕКТОР TEL LT RJ11 6/4

- телефонен LT винтов
- винтови контакти
- RJ11 6/4
- в съответствие с IEC 60603-7

SOCKET TEL LT RJ11 6/4

- TEL LT screw
- screw contacts
- RJ11 6/4
- in accordance with IEC 60603-7

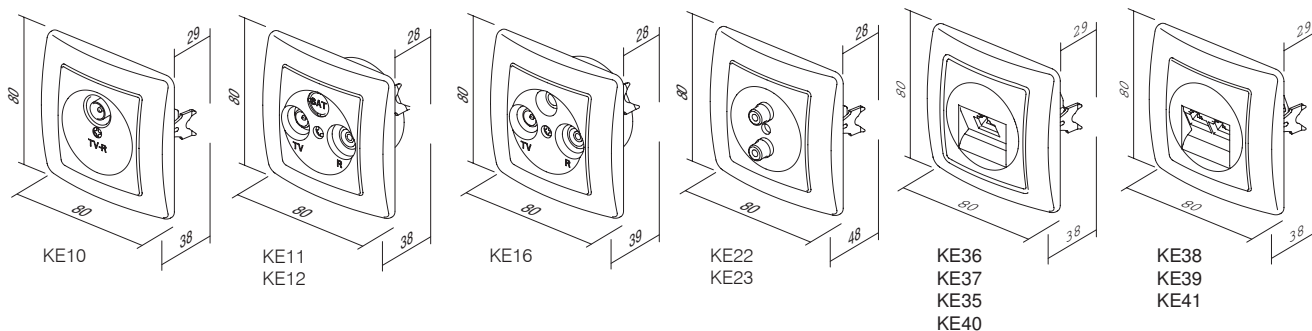

П А Н Е Л И З А К О М У Н И К А Ц И И К Е



PE20

PW

тип type	описание description	технически данни technical data	ЦВЯТ colour
PE10	ПАНЕЛ ЗА ТВ-РАДИО COVER TV-R	2P/3P	<input type="checkbox"/> PW снежнобял цвят polar white
PE20	ПАНЕЛ KS ЕДИНИЧЕН COVER KS SINGLE		<input type="checkbox"/> IW слонова кост ivory white
PE21	ПАНЕЛ KS ДВОЕН COVER KS DOUBLE		<input type="checkbox"/> ES сребрист цвят с анодизирано покритие elox silver
...	<input type="checkbox"/> CO бял с термореактивен материал white thermoset
			<input type="checkbox"/> NB тъмночерен night black

ПАНЕЛ ЗА ТВ-РАДИО 2P/3P



- PE10PW
- PE10IW
- PE10ES
- PE10CO
- PE10NB

- панел за ТВ-радио, 2P или 3P с винт

COVER TV-R 2P/3P

- TV-R cover, 2P or 3P with screw



ПАНЕЛ KS ЕДИНИЧЕН



- PE20PW
- PE20IW
- PE20ES
- PE20CO
- PE20NB

- панел KS единичен

COVER KS SINGLE

- KS cover single



ПАНЕЛ KS ДВОЕН

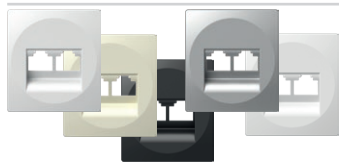

- PE21PW
- PE21IW
- PE21ES
- PE21NB

- панел KS двоен

COVER KS DOUBLE

- KS cover double



ПАНЕЛ TAE/TDO



- PE30PW
- PE30IW
- PE30ES
- PE30NB

- панел TAE или TDO с винт

COVER TAE/TDO

- TAE or TDO cover with screw

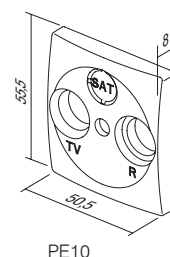
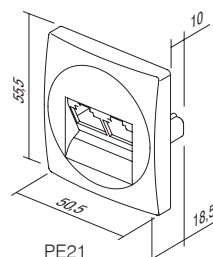
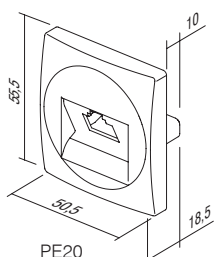
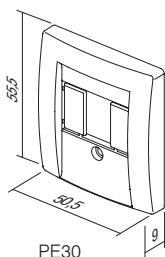



EE15

PW

тип type	описание description	технически данни technical data	цвет colour
EE15	DIMMER ROTATIVE 2WAY DIMMER ROTATIVE 2WAY	RL 400W	<input type="checkbox"/> PW снежнобял цвят polar white
EE16	DIMMER ROTATIVE 2WAY DIMMER ROTATIVE 2WAY	RLC 400W	<input type="checkbox"/> IW слонова кост ivory white
EE19	DIMMER ROTATIVE 2WAY DIMMER ROTATIVE 2WAY	LED 100W	<input type="checkbox"/> ES сребрист цвят с анодизирано покритие elox silver
⋮	⋮	⋮	<input type="checkbox"/> CO бял с термореактивен материал white thermoset
⋮	⋮	⋮	<input type="checkbox"/> NB тъмночерен night black

ДИМЕР, ВЪРТЯЩ ТИП/ДВУПОСОЧЕН, АКТИВЕН/ИНДУКТИВЕН ТОВАР 400 W



EE15

- управление чрез завъртане, с двупосочен ключ
- активен/индуктивен товар, 40 W – 400 W
- възможна е комбинация с двупосочен ключ
- не се допуска комбинация с допълнителни димери
- в съответствие с EN 60669-1 и EN 60669-2-1
- контакти чрез вкарване на проводниците 1,5 mm²
- захранващо напрежение 230 V~ 50 Hz
- вътрешен диаметър на бутона Ø6 mm
- предпазител за смяна е включен в доставката

DIMMER ROTATIVE 2WAY RL 400W

- rotation control with 2-way switch
- load RL, 40W - 400W
- 2-way switch combination is possible
- more dimmers combination is not allowed
- in accordance with EN 60669-1 and EN 60669-2-1
- plug-in contacts 1.5mm²
- supply 230V~ 50Hz
- button inner diameter Ø6mm
- replaceable fuse included

ДИМЕР, ВЪРТЯЩ ТИП/ДВУПОСОЧЕН, АКТИВЕН/ИНДУКТИВЕН/КАПАЦИТИВЕН ТОВАР 400 W



EE16

- управление чрез завъртане, с двупосочен ключ
- активен/индуктивен/капацитивен товар, 20 W – 400 W
- възможна е комбинация с двупосочен ключ
- не се допуска комбинация с допълнителни димери
- в съответствие с EN 60669-1 и EN 60669-2-1
- контакти чрез вкарване на проводниците 1,5 mm²
- захранващо напрежение 230 V~ 50 Hz
- вътрешен диаметър на бутона Ø6 mm
- електронен предпазител

DIMMER ROTATIVE 2WAY RLC 400W

- rotation control with 2-way switch
- load RLC, 20W - 400W
- 2-way switch combination is possible
- more dimmers combination is not allowed
- in accordance with EN 60669-1 and EN 60669-2-1
- plug-in contacts 1.5mm²
- supply 230V~ 50Hz
- button inner diameter Ø6mm
- electronic fuse

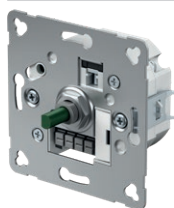

EE19

ДИМЕР, ВЪРТЯЩ ТИП/ДВУПОСОЧЕН, ЗА СВЕТОДИОДНО ОСВЕТЛЕНИЕ 100 W

- управление чрез завъртане, с двупосочен ключ
- товар: светодиодно осветление, 0 - 100 W (max. 10 светодиода)
GLS, 10-250 W
- възможна е комбинация с двупосочен ключ
- не се допуска комбинация с допълнителни димери
- в съответствие с EN 60669-1 и EN 60669-2-1
- контакти чрез вкарване на проводниците 1,5 mm²
- захранващо напрежение 230 V~ 50 Hz
- предпазител за смяна е включен в доставката
- вътрешен диаметър на бутона Ø6 mm

DIMMER ROTATIVE 2WAY LED 100W

- rotation control with 2-way switch
- load: LED, 0-100W (max. 10 LEDs)
GLS, 10-250W
- 2-way switch combination is possible
- more dimmers combination is not allowed
- in accordance with EN 60669-1 and EN 60669-2-1
- plug-in contacts 1.5mm²
- supply 230V~ 50Hz
- replaceable fuse included
- button inner diameter Ø6mm

IR КЛЮЧ 5 А 250 V~

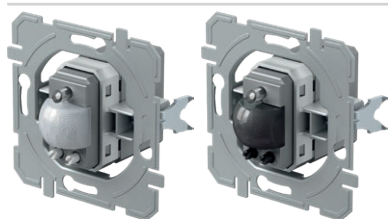

- EE32A1
- EE32A2

- инфрачервен ключ IR
- захранване: 230 V~ ±10 % 50 Hz
- реле: 5 A/250 V~ (нулевата стойност)
- клас на защита: IP40
- сечение на проводниците при контакта 0,75 - 2,5 mm²
- ъгъл на откриване: до 110° при 20° C
- разстояние на откриване: прил. 8 m при 20° C
- регулируема продължителност: от прил. 5 сек до 12 мин
- регулиране на яркостта на осветлението: от прил. 5 до 200 лукса
- работна температура: от 0° C до +40° C
- не е подходящо за инсталиране в конзоли с дълбочина 45 mm
- само за използване на закрито

IR SWITCH 5A 230V~

- IR infrared switch
- supply voltage: 230V~ ±10 % 50Hz
- relay: 5A / 250V~ (zero crossing)
- protection rating: IP40
- cross-section of wires at the contact terminal: 0.75 - 2.5 mm²
- detection angle: up to 110° at 20°C
- detection area: approx. 8 m at 20°C
- adjustability of duration: from approx. 5 s to 12 min
- adjustability of brightness: from approx. 5 to 200 LUX
- operating temperature: from 0°C to +40°C
- not suitable for installation in 45 mm deep boxes
- only for indoor usage

USB ЗАХРАНВАЩ БЛОК 5V 2,4A



EE67

- за зареждане на електронни устройства чрез стандартен USB порт (съвместим с устройства на Apple)
- захранване: 100-230V~ 50/60Hz
- консумация на енергия:
300mA при 100V~/150mA при 230V~
- консумация на енергия в режим на готовност: 30mW при 230V~
- номинално изходно напрежение: 5 VCD (± 5%) SELV
- изходно напрежение на пулсации: 150 mV
- номинален изходен ток: 2,4A (±10%)
- вид конектор: USB A/USB A
- ефективност: максимум 77%
- температура на работа: 0° C/+45° C (за употреба в затворени пространства)
- Клас на IP защита: IP20, само за употреба в затворени пространства
- устройство клас II
- категория свръхнапрежение (EN 62109): Клас III
- контакти с винтови клеми: макс. 2,5 mm²
- устройство с контактна междина най-малко 3 mm
- в съответствие с Директива EN 60950-1 и Директива за безопасност на нисковолтови електрически съоръжения (LVD) и Директива относно електромагнитна съвместимост (EMC)

USB POWER SUPPLY UNIT 5V 2.4A

- for charging electronic devices via a standard USB port (also compatible with Apple devices)
- power supply: 100-230V~ 50/60Hz
- power consumption: 300mA at 100V~/150mA at 230V~
- standby power consumption: 30mW at 230V~
- nominal output voltage: 5 VCD (± 5%) SELV
- output ripple voltage: 150mV
- nominal output current: 2.4A (±10%)
- connector type: USB A / USB A
- efficiency: maximum of 77%
- operating temperature: 0°C/+45°C (indoor use)
- IP protection class: IP20, indoor use only
- class device II
- overvoltage category (EN 62109): Class III
- screw contacts: max. 2.5 mm²
- device with a contact gap of at least 3mm
- in accordance with the EN 60950-1 and LVD & EMC directives

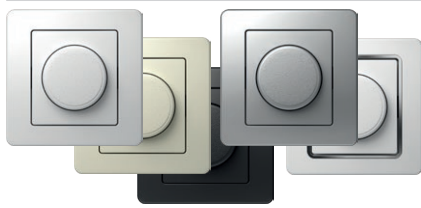

- EE15PW
- EE15IW
- EE15ES
- EE15CO
- EE15NB

ДИМЕР, ВЪРТЯЩ ТИП/ДУПОСОЧЕН, АКТИВЕН/ИНДУКТИВЕН ТОВАР 400 W

- управление чрез завъртане, с двупосочен ключ
- активен/индуктивен товар, 40 W – 400 W
- възможна е комбинация с двупосочен ключ
- не се допуска комбинация с допълнителни димери
- в съответствие с EN 60669-1 и EN 60669-2-1
- контакти чрез вкарване на проводниците 1,5 mm²
- захранващо напрежение 230 V~ 50 Hz
- предпазител за смяна е включен в доставката



DIMMER ROTATIVE 2WAY RL 400W

- rotation control with 2-way switch
- load RL, 40W - 400W
- 2-way switch combination is possible
- more dimmers combination is not allowed
- in accordance with EN 60669-1 and EN 60669-2-1
- plug-in contacts 1.5mm²
- supply 230V~ 50Hz
- replaceable fuse included

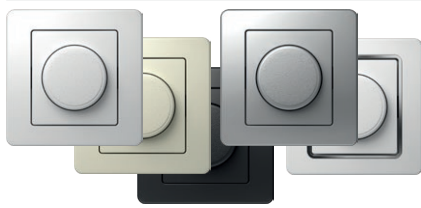

- EE16PW
- EE16IW
- EE16ES
- EE16CO
- EE16NB

ДИМЕР, ВЪРТЯЩ ТИП/ДУПОСОЧЕН, АКТИВЕН/ИНДУКТИВЕН/КАПАЦИТИВЕН ТОВАР 400 W

- управление чрез завъртане, с двупосочен ключ
- активен/индуктивен/капацитивен товар, 20 W – 400 W
- възможна е комбинация с двупосочен ключ
- не се допуска комбинация с допълнителни димери
- в съответствие с EN 60669-1 и EN 60669-2-1
- контакти чрез вкарване на проводниците 1,5 mm²
- захранващо напрежение 230 V~ 50 Hz
- електронен предпазител



DIMMER ROTATIVE 2WAY RLC 400W

- rotation control with 2-way switch
- load RLC, 20W - 400W
- 2-way switch combination is possible
- more dimmers combination is not allowed
- in accordance with EN 60669-1 and EN 60669-2-1
- plug-in contacts 1.5mm²
- supply 230V~ 50Hz
- electronic fuse

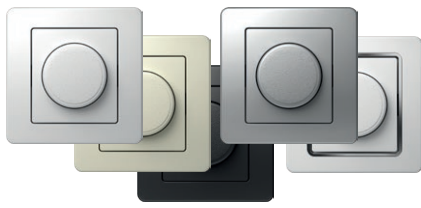

- EE19PW
- EE19IW
- EE19ES
- EE19CO
- EE19NB

ДИМЕР, ВЪРТЯЩ ТИП/ДУПОСОЧЕН, ЗА СВЕТОДИОДНО ОСВЕТЛЕНИЕ 100 W

- управление чрез завъртане, с двупосочен ключ
- товар: светодиодно осветление, 0 - 100 W (max. 10 светодиода)
GLS, 10-250 W
- възможна е комбинация с двупосочен ключ
- не се допуска комбинация с допълнителни димери
- в съответствие с EN 60669-1 и EN 60669-2-1
- контакти чрез вкарване на проводниците 1,5 mm²
- захранващо напрежение 230 V~ 50 Hz
- предпазител за смяна е включен в доставката



DIMMER ROTATIVE 2WAY LED 100W

- rotation control with 2-way switch
- load: LED, 0-100W (max. 10 LEDs)
GLS, 10-250W
- 2-way switch combination is possible
- more dimmers combination is not allowed
- in accordance with EN 60669-1 and EN 60669-2-1
- plug-in contacts 1.5mm²
- supply 230V~ 50Hz
- replaceable fuse included



- EE32PW
- EE32IW
- EE32ES
- EE32CO
- EE32NB

IR КЛЮЧ 5 A 230V~

- инфрачервен ключ IR
- захранване: 230 V~ ±10 % 50 Hz
- реле: 5 A/250 V~ (нулевата стойност)
- клас на защита: IP40
- сечение на проводниците при контакта 0,75 - 2,5 mm²
- ъгъл на откриване: до 110° при 20° C
- разстояние на откриване: прил. 8 m при 20° C
- регулируема продължителност: от прил. 5 сек до 12 мин
- регулиране на яркостта на осветлението: от прил. 5 до 200 лукса
- работна температура: от 0° C до +40° C
- не е подходящо за инсталиране в конзоли с дълбочина 45 mm
- само за използване на закрито



IR SWITCH 5A 230V~

- IR infrared switch
- supply voltage: 230V~ ±10 % 50Hz
- relay: 5A / 250V~ (zero crossing)
- protection rating: IP40
- cross-section of wires at the contact terminal: 0.75 - 2.5 mm²
- detection angle: up to 110° at 20°C
- detection area: approx. 8 m at 20°C
- adjustability of duration: from approx. 5 s to 12 min
- adjustability of brightness: from approx. 5 to 200 LUX
- operating temperature: from 0°C to +40°C
- not suitable for installation in 45 mm deep boxes
- only for indoor usage



- EE67PW
- EE67IW
- EE67NB
- EE67ES

USB ЗАХРАНВАЩ БЛОК 5V 2,4A

- за зареждане на електронни устройства чрез стандартен USB порт (съвместим с устройства на Apple)
- захранване: 100-230V~ 50/60Hz
- консумация на енергия: 300mA при 100V~/150mA при 230V~
- консумация на енергия в режим на готовност: 30mW при 230V~
- номинално изходно напрежение: 5 VCD ($\pm 5\%$) SELV
- изходно напрежение на пулсации: 150 mV
- номинален изходен ток: 2,4A ($\pm 10\%$)
- вид конектор: USB A/USB A
- ефективност: максимум 77%
- температура на работа: 0°C/+45°C (за употреба в затворени пространства)
- Клас на IP защита: IP20, само за употреба в затворени пространства
- устройство клас II
- категория свръхнапрежение (EN 62109): Клас III
- контакти с винтови клеми: макс. 2,5 mm²
- устройство с контактна междина най-малко 3 mm
- в съответствие с Директива EN 60950-1 и Директива за безопасност на нисковолтови електрически съоръжения (LVD) и Директива относно електромагнитна съвместимост (EMC)



USB POWER SUPPLY UNIT 5V 2.4A

- for charging electronic devices via a standard USB port (also compatible with Apple devices)
- power supply: 100-230V~ 50/60Hz
- power consumption: 300mA at 100V~/150mA at 230V~
- standby power consumption: 30mW at 230V~
- nominal output voltage: 5 VCD ($\pm 5\%$) SELV
- output ripple voltage: 150mV
- nominal output current: 2.4A ($\pm 10\%$)
- connector type: USB A / USB A
- efficiency: maximum of 77%
- operating temperature: 0°C/+45°C (indoor use)
- IP protection class: IP20, indoor use only
- class device II
- overvoltage category (EN 62109): Class III
- screw contacts: max. 2.5 mm²
- device with a contact gap of at least 3mm
- in accordance with the EN 60950-1 and LVD & EMC directives

EE15, EE16, EE19

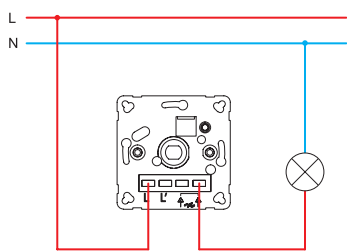

EE15, EE16, EE19

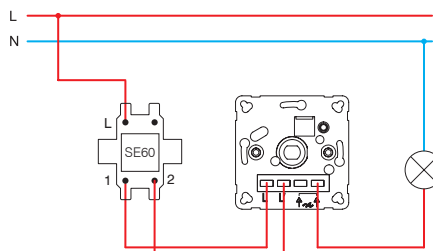

EE15, EE16, EE19

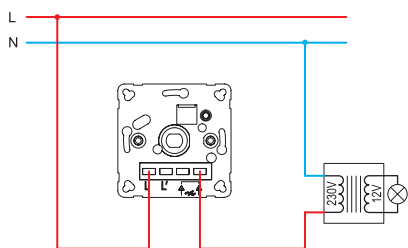

EE15, EE16, EE19

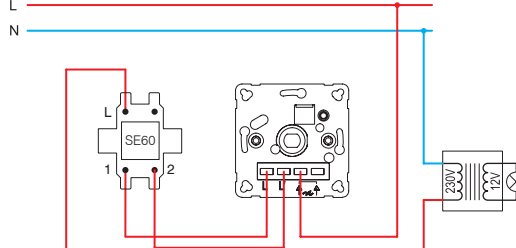

EE16, EE19

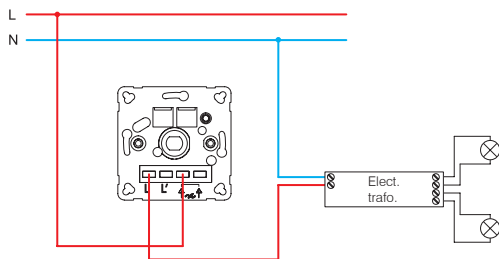

EE16, EE19

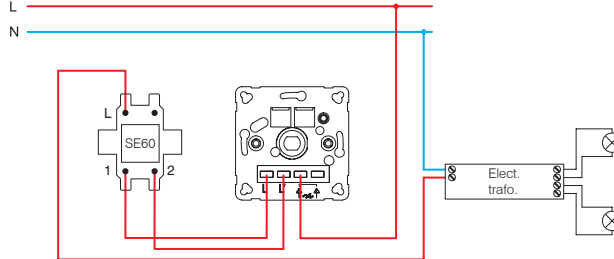

EE15 (40÷400W)

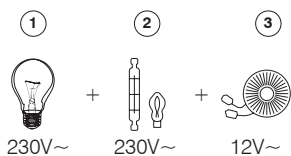

EE16 (20÷400W)

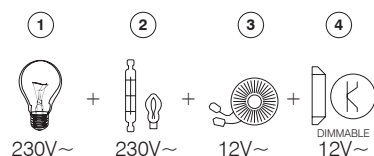

EE19 (GLS 10÷250W ; LED 0÷100W)

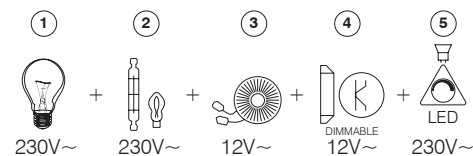

- 1 – лампа с нажежаема жичка / incandescent lamp
- 2 – халогенна лампа / halogen lamp

- 3 – класически трансформатор / classical transformer
- 4 – Димиращ електронен трансформатор / dimmable electronic transformer
- 5 – димируема светодиодна лампа / dimmable LED lamp

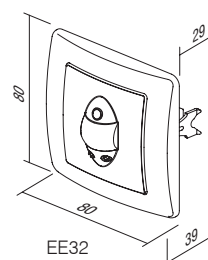
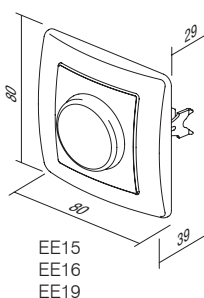
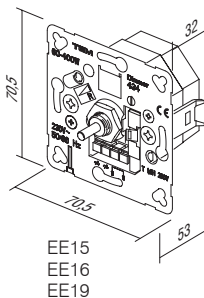
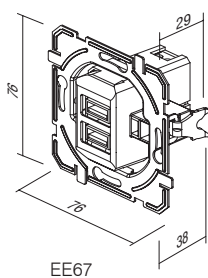

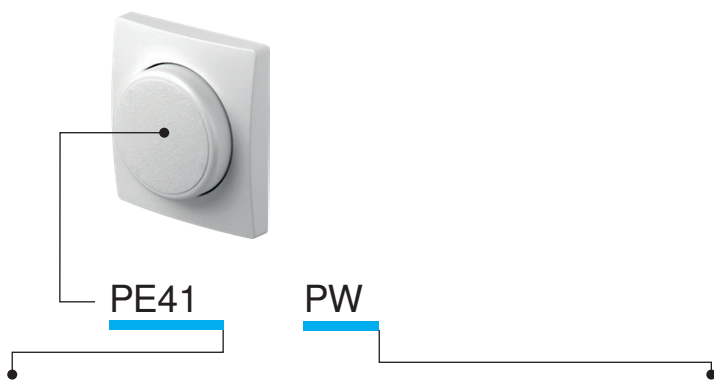

тип type	описание description	ЦВЯТ colour
PE41	ПАНЕЛ ЗА ДИМЕР COVER DIMMER	<input type="checkbox"/> PW снежнобял цвят polar white <input type="checkbox"/> IW слонова кост ivory white <input type="checkbox"/> ES сребрист цвят с анодизирано покритие elox silver <input type="checkbox"/> CO бял с термореактивен материал white thermoset <input type="checkbox"/> NB тъмночерен night black

ПАНЕЛ ЗА ДИМЕР Ø6



- PE41PW
- PE41IW
- PE41NB
- PE41ES
- PE41CO

- панел за димер Ø6 mm
- за EE15, EE16, EE19

COVER DIMMER Ø6

- cover dimmer Ø6mm
- for EE15, EE16, EE19



ПАНЕЛ IR КЛЮЧ



- PE32PW
- PE32IW
- PE32NB
- PE32ES

- панел за ИЧ ключ

COVER IR SWITCH

- cover IR switch



КАПАК ЗА USB ЗАХРАНВАЩ БЛОК



- PE67PW
- PE67IW
- PE67NB
- PE67ES

- Капак за USB захранващ блок

USB SUPPLY UNIT COVER

- USB supply unit cover

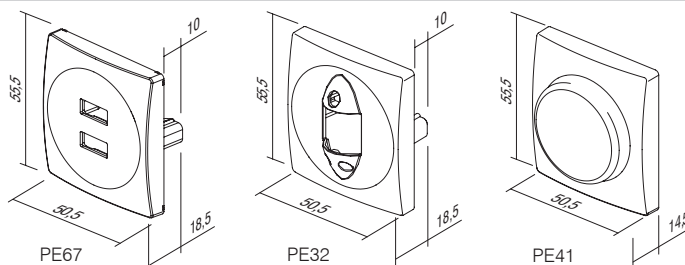

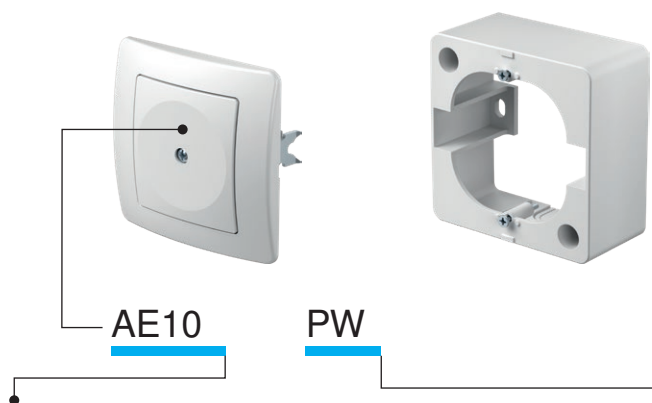

тип type	описание description	цвет colour
AE10	КАПАЧЕ BLANK	<input type="checkbox"/> PW снежнобял цвят polar white
AE20	СЪЕДИНИТЕЛНА КОНЗОЛА 5POLE 3P+N+E 5x4 mm ² CONNECTION BOX 3P+N+E 5X4mm ²	<input type="checkbox"/> IW слонова кост ivory white
AE30	КОНЗОЛА ЗА ВЪНШЕН МОНТАЖ 1 SURFACE MOUNT BOX	<input type="checkbox"/> ES сребрист цвят с анодизирано покритие elox silver
⋮	⋮	<input type="checkbox"/> CO бял с термореактивен материал white thermoset
⋮	⋮	<input type="checkbox"/> NB тъмночерен night black

КАПАЧЕ



- AE10PW
- AE10IW
- AE10NB
- AE10ES
- AE10CO

- за запълване на празни позиции

BLANK

- for filling up empty spaces

СЪЕДИНИТЕЛНА КОНЗОЛА 5POLE 3P+N+E 5x4 mm²

- AE20PW
- AE20IW

- съединителна конзола 3P +N+E
- 16 A 400 V~
- в съответствие с VDE 0606-1:2000
- винтови контакти 1,5 - 4 mm²

CONNECTION BOX 5POLE 3P+N+E 5x4mm²

- 3P+N+E connection box
- 16A 400V~
- in accordance with VDE 0606-1:2000
- screw contacts 1.5-4mm²



КОНЗОЛА ЗА ВЪНШЕН МОНТАЖ 1

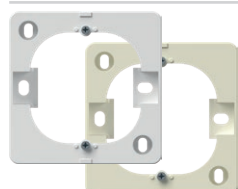

- AE30PW
- AE30IW

- конзола за външен монтаж

SURFACE MOUNT BOX 1

- surface mounting box



КУТИЯ ЗА МОНТАЖ НА ПОВЪРХНОСТИ ЗА ДВОЕН КОНТАКТ

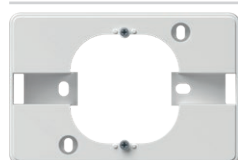

- AE31PW

- конзола за външен монтаж

SURFACE MOUNT BOX FOR

EKONOMIK DOUBLE SOCKET

- surface mounting box



СТЕННА ЗАЩИТА



- AE50PW
- AE50TS

- защитава повърхността около контакт или ключ

WALL PROTECTION

- protects surface around socket or switch

ЗАЩИТА ЗА ДЕЦА KS



- AE51PW
- AE51IW

- KS допълнителен елемент за защита за деца

CHILD PROTECTION KS

- KS additional child protection insert - shuttered live contacts

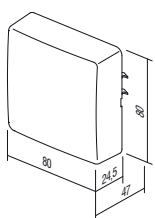

AE20

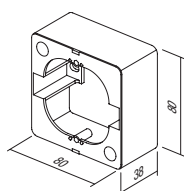

AE30

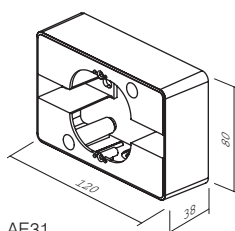

AE31

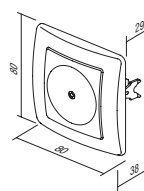

AE10

S U R R O U N D S O E

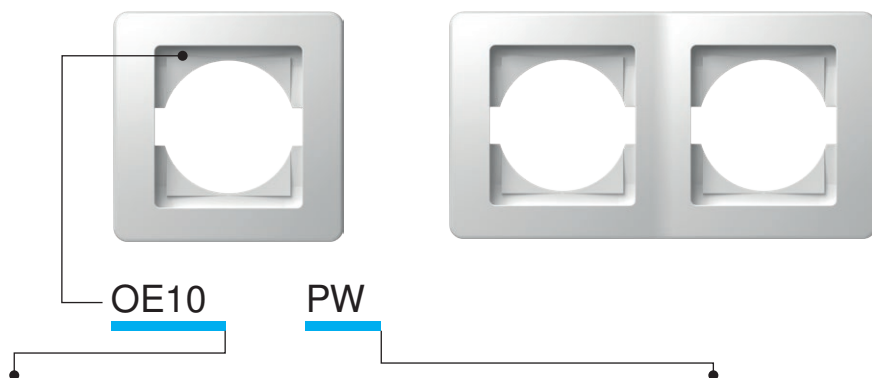

тип type	описание description	цвет colour
OE10	РАМКА ЕКОНОМИК 1 SURROUND EKONOMIK 1	<input type="checkbox"/> PW снежнобял цвят polar white
OE20	РАМКА ЕКОНОМИК 2 ХОРИЗОНТАЛНА SURROUND EKONOMIK 2 HORIZONTAL	<input type="checkbox"/> IW слонова кост ivory white
OE30	РАМКА ЕКОНОМИК 3 ХОРИЗОНТАЛНА SURROUND EKONOMIK 3 HORIZONTAL	<input type="checkbox"/> ES сребрист цвят с анодизирано покритие elox silver
⋮	⋮	<input type="checkbox"/> CO бял с термореактивен материал white thermoset
⋮	⋮	<input type="checkbox"/> NB тъмночерен night black

РАМКА ЕКОНОМИК 1



- OE10PW
- OE10IW
- OE10ES
- OE10CO
- OE10NB

- декоративна рамка единична
- в съответствие с EN 60669-1

SURROUND EKONOMIK 1
- decorative surround 1-gang
- in accordance with EN 60669-1

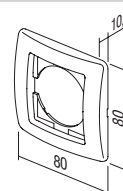

РАМКА ЕКОНОМИК 2 ХОРИЗОНТАЛНА



- OE20PW
- OE20IW
- OE20ES
- OE20CO
- OE20NB

- декоративна рамка двойна хоризонтална
- в съответствие с EN 60669-1

SURROUND EKONOMIK 2 HORIZONTAL
- decorative surround 2-gang horizontal
- in accordance with EN 60669-1

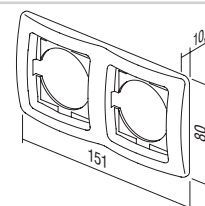

РАМКА ЕКОНОМИК 2 ВЕРТИКАЛНА



- OE21PW
- OE21IW
- OE21ES
- OE21CO
- OE21NB

- декоративна рамка двойна вертикална
- в съответствие с EN 60669-1

SURROUND EKONOMIK 2 VERTICAL
- decorative surround 2-gang vertical
- in accordance with EN 60669-1

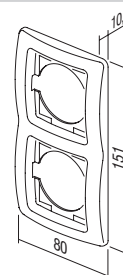

РАМКА ЕКОНОМИК 3 ХОРИЗОНТАЛНА



- OE30PW
- OE30IW
- OE30ES
- OE30CO
- OE30NB

- декоративна рамка тройна хоризонтална
- в съответствие с EN 60669-1

SURROUND EKONOMIK 3 HORIZONTAL
- decorative surround 3-gang horizontal
- in accordance with EN 60669-1

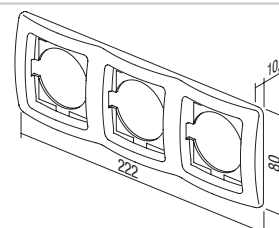

РАМКА ЕКОНОМІК 3 ВЕРТИКАЛНА



- OE31PW
- OE31IW
- OE31ES
- OE31CO
- OE31NB

- декоративна рамка тройна вертикална
- в съответствие с EN 60669-1

SURROUND EKONOMIK 3 VERTICAL
- decorative surround 3-gang vertical
- in accordance with EN 60669-1

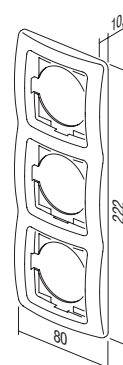

РАМКА ЕКОНОМІК 4 ХОРИЗОНТАЛНА



- OE40PW
- OE40IW
- OE40ES
- OE40NB

- декоративна рамка четворна хоризонтална
- в съответствие с EN 60669-1

SURROUND EKONOMIK 4 HORIZONTAL
- decorative surround 4-gang horizontal
- in accordance with EN 60669-1

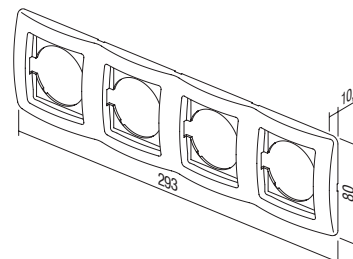

РАМКА ЕКОНОМІК 4 ВЕРТИКАЛНА



- OE41PW
- OE41IW
- OE41ES
- OE41NB

- декоративна рамка четворна вертикална
- в съответствие с EN 60669-1

SURROUND EKONOMIK 4 VERTICAL
- decorative surround 4-gang vertical
- in accordance with EN 60669-1



РАМКА ЕКОНОМІК 5 ХОРИЗОНТАЛНА



- OE50PW
- OE50IW
- OE50ES
- OE50NB

- декоративна рамка петорна хоризонтална
- в съответствие с EN 60669-1

SURROUND EKONOMIK 5 HORIZONTAL
- decorative surround 5-gang horizontal
- in accordance with EN 60669-1

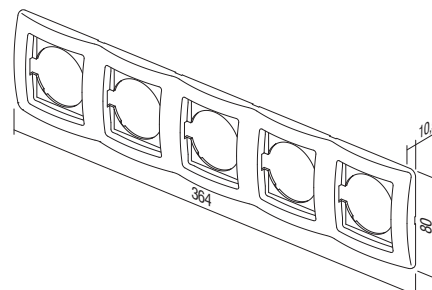

ЦВЕТНИ ДЕКОРАТИВНИ РАМКИ /
 COLOR DECORATIVE FRAMES



OE90GR	ЗЕЛЕНА / GREEN	OE90YL	ЖЪЛТА / YELLOW	OE90MB	МЕТ. СИНЯ / MET. BLUE
OE90BL	СИНЯ / BLUE	OE90WH	БЯЛА / WHITE	OE90BZ	БРОНЗ / BRONZE
OE90VO	ВИОЛЕТОВА / VIOLET	OE90GY	СИВА / GREY	OE90CR	СРЕБРИСТА / SILVER
OE90PI	РОЗОВА / PINK	OE90BK	ЧЕРНА / BLACK	OE90GO	ЗЛАТИСТА / GOLD
OE90RD	ЧЕРВЕНА / RED				





fontana



TEM



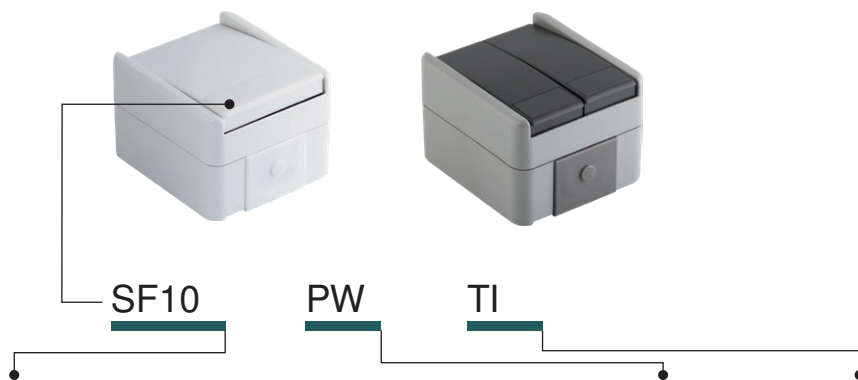

тип type	описание description	технически данни technical data	цвет colour	допълнителна информация 1 optional data 1
SF10	SWITCH 1WAY SWITCH 1WAY	IP44 10AX 250V~	<input type="checkbox"/> PW бял-матов white-mat	TI неонов лампа+индикация neon lamp+indication
SF11	PUSH BUTTON 1WAY PUSH BUTTON 1WAY	IP44 10A 250V~	<input type="checkbox"/> GY сив-матов grey-mat	
SF20	SWITCH 2POLE SWITCH 2POLE	IP44 10AX 250V~		
:	:	:		
:	:	:		

КЛЮЧ 1WAY IP44 10AX 250V~



- SF10PW
- SF10GY

- 10AX 250V~, тип SF10
- в съответствие с EN 60669-1
- контакти чрез вкарване 1,5 - 2,5 mm²

SWITCH 1WAY IP44 10AX 250V~
- 10AX 250V~, type SF10
- in accordance with EN 60669-1
- plug-in contacts 1.5-2.5mm²



КЛЮЧ 1WAY IP44 10AX 250V~ __ TI



- SF10PWTI
- SF10GYTI

- TI индикатор+неонова лампа
- 10AX 250V~, тип SF10
- в съответствие с EN 60669-1
- контакти чрез вкарване 1,5 - 2,5 mm²

SWITCH 1WAY IP44 10AX 250V~ __ TI
- TI indicator+neon lamp
- 10AX 250V~, type SF10
- in accordance with EN 60669-1
- plug-in contacts 1.5-2.5mm²



БУТОН 1WAY IP44 10A 250V~ __ TI



- SF11PWTI
- SF11GYTI

- TI индикатор+неонова лампа
- 10A 250V~, тип SF11
- в съответствие с EN 60669-1
- контакти чрез вкарване 1,5 - 2,5 mm²

PUSH BUTTON 1WAY IP44 10A 250V~ __ TI
- TI indicator+neon lamp
- 10A 250V~, type SF11
- in accordance with EN 60669-1
- plug-in contacts 1.5-2.5mm²



КЛЮЧ 2POLE IP44 10AX 250V~



- SF20PW
- SF20GY

- 10AX 250V~, тип SF20
- в съответствие с EN 60669-1
- контакти чрез вкарване 1,5 - 2,5 mm²

SWITCH 2POLE IP44 10AX 250V~
- 10AX 250V~, type SF20
- in accordance with EN 60669-1
- plug-in contacts 1.5-2.5mm²



	<ul style="list-style-type: none"> <input type="checkbox"/> SF50PW <input checked="" type="checkbox"/> SF50GY 	<p>КЛЮЧ 2GANG-1WAY IP44 10AX 250V~</p> <ul style="list-style-type: none"> - 10AX 250V~, тип SF50 - в съответствие с EN 60669-1 - контакти чрез вкарване 1,5 - 2,5 mm² <p><i>SWITCH 2GANG-1WAY IP44 10AX 250V~</i></p> <ul style="list-style-type: none"> - 10AX 250V~, type SF50 - in accordance with EN 60669-1 - plug-in contacts 1.5-2.5mm² 	
	<ul style="list-style-type: none"> <input type="checkbox"/> SF51PW <input checked="" type="checkbox"/> SF51GY 	<p>БУТОН 2GANG-1WAY IP44 10A 250V~</p> <ul style="list-style-type: none"> - 10 A 250 V~, тип SF51 - в съответствие с EN 60669-1 - контакти чрез вкарване 1,5 - 2,5 mm² <p><i>PUSH BUTTON 2GANG-1WAY IP44 10A 250V~</i></p> <ul style="list-style-type: none"> - 10A 250V~, type SF51 - in accordance with EN 60669-1 - plug-in contacts 1.5-2.5mm² 	
	<ul style="list-style-type: none"> <input type="checkbox"/> SF60PW <input checked="" type="checkbox"/> SF60GY 	<p>КЛЮЧ 2WAY IP44 10AX 250V~</p> <ul style="list-style-type: none"> - 10AX 250V~, тип SF60 - в съответствие с EN 60669-1 - контакти чрез вкарване 1,5 - 2,5 mm² <p><i>SWITCH 2WAY IP44 10AX 250V~</i></p> <ul style="list-style-type: none"> - 10AX 250V~, type SF60 - in accordance with EN 60669-1 - plug-in contacts 1.5-2.5mm² 	
	<ul style="list-style-type: none"> <input type="checkbox"/> SF60PWTI <input checked="" type="checkbox"/> SF60GYTI 	<p>КЛЮЧ 2WAY IP44 10AX 250V~ __ TI</p> <ul style="list-style-type: none"> - TI индикатор+неонова лампа - 10AX 250V~, тип SF60 - в съответствие с EN 60669-1 - контакти чрез вкарване 1,5 - 2,5 mm² <p><i>SWITCH 2WAY IP44 10AX 250V~ __ TI</i></p> <ul style="list-style-type: none"> - TI indicator+neon lamp - 10AX 250V~, type SF60 - in accordance with EN 60669-1 - plug-in contacts 1.5-2.5mm² 	
	<ul style="list-style-type: none"> <input type="checkbox"/> SF63PW <input checked="" type="checkbox"/> SF63GY 	<p>КЛЮЧ 2WAY DOUBLE IP44 10AX 250V~</p> <ul style="list-style-type: none"> - 10AX 250V~, тип SF63 - в съответствие с EN 60669-1 - контакти чрез вкарване 1,5 - 2,5 mm² <p><i>SWITCH 2WAY DOUBLE IP44 10AX 250V~</i></p> <ul style="list-style-type: none"> - 10AX 250V~, type SF63 - in accordance with EN 60669-1 - plug-in contacts 1.5-2.5mm² 	
	<ul style="list-style-type: none"> <input type="checkbox"/> SF70PW <input checked="" type="checkbox"/> SF70GY 	<p>КРЪСТАТ КЛЮЧ IP44 10AX 250V~</p> <ul style="list-style-type: none"> - 10AX 250V~, тип SF70 - в съответствие с EN 60669-1 - контакти чрез вкарване 1,5 - 2,5 mm² <p><i>SWITCH INTERMEDIATE IP44 10AX 250V~</i></p> <ul style="list-style-type: none"> - 10AX 250V~, type SF70 - in accordance with EN 60669-1 - plug-in contacts 1.5-2.5mm² 	

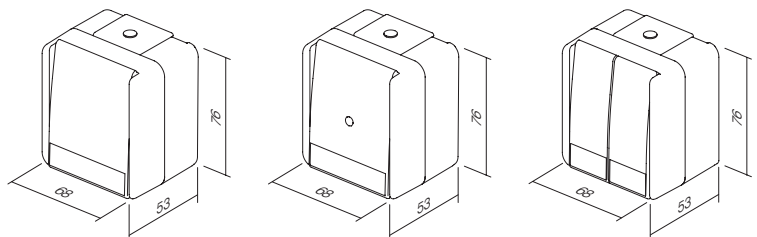

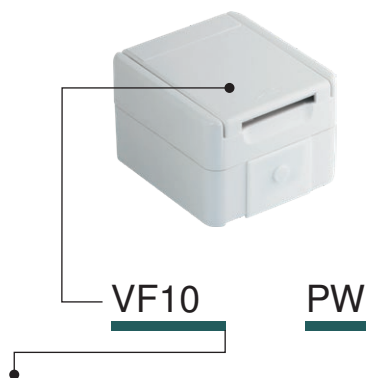

тип type	описание description	технически данни technical data	цвет colour
VF10	КОНТАКТ SCHUKO+КАПАК SOCKET SCHUKO+COVER	IP44 2P+E 16A 250V~	<input type="checkbox"/> PW бял-матов white-mat <input type="checkbox"/> GY сив-матов grey-mat



- VF10PW
- VF10GY

КОНТАКТ SCHUKO+КАПАК IP44 2P+E 16A 250V~

- винтови контакти 1,5 - 2,5 mm²
- 2P+E шуко+капак
- 16A 250 V~, тип VF10
- в съответствие с EN 60884-1, CEE7

SOCKET SCHUKO+COVER IP44 2P+E 16A 250V~

- screw contacts 1.5-2.5mm²
- 2P+E schuko+cover
- 16A 250V~, type VF10
- in accordance with EN 60884-1, CEE7



- VF12PW
- VF12GY

КОНТАКТ SCHUKO+КАПАК IP44 2P+E 16A 250V~ BV

- BV контакти чрез вкарване 1,5 - 2,5 mm²
- 2P+E шуко+капак
- 16A 250 V~, тип VF12
- в съответствие с EN 60884-1, CEE7

SOCKET SCHUKO+COVER IP44 2P+E 16A 250V~ BV

- BV plug-in contacts 1.5-2.5mm²
- 2P+E schuko+cover
- 16A 250V~, type VF12
- in accordance with EN 60884-1, CEE7

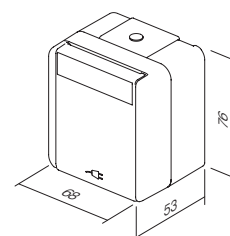

VF10
VF12

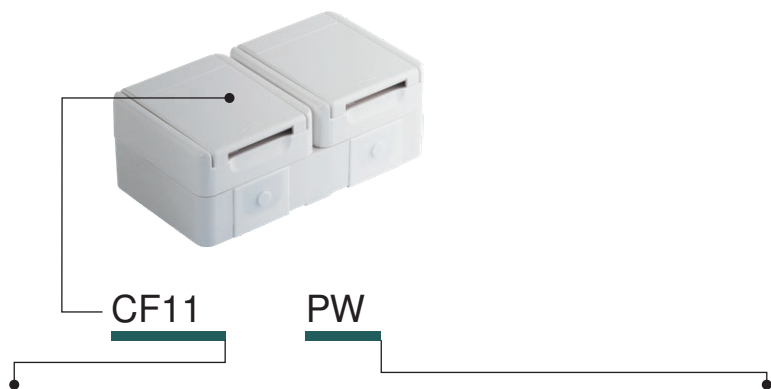

тип type	описание description	технически данни technical data	цвет colour
CF10	КОМПЛЕКТ КОНТАКТИ ШУКО ДВОЙНИ ХОРИЗОНТАЛНИ <i>SOCKET SET SCHUKO DOUBLE HORIZ</i>	2x 2P+E 16A 250V~ IP44	<input type="checkbox"/> PW бял-матов <i>white-mat</i>
CF11	КОМПЛЕКТ КОНТАКТИ ШУКО ДВОЙНИ ВЕРТИКАЛНИ <i>SOCKET SET SCHUKO DOUBLE VERT</i>	2x 2P+E 16A 250V~ IP44	<input checked="" type="checkbox"/> GY сив-матов <i>grey-mat</i>
CF12	КОМПЛЕКТ КОНТАКТИ ШУКО ДВОЙНИ ВЕРТИКАЛНИ <i>SOCKET SCH+SWITCH 2WAY HORIZ</i>	16A + 10A 250V~ IP44	
⋮	⋮	⋮	
⋮	⋮	⋮	



- CF10PW
 CF10GY

КОМПЛЕКТ КОНТАКТИ ШУКО ДВОЙНИ ХОРИЗОНТАЛНИ IP44 2x 2P+E 16A 250V~

- винтови контакти 1,5 - 2,5 mm²
- 2x 2P+E шуко+капак хоризонтални
- 16A 250 V~, тип CF10
- в съответствие с EN 60884-1, CEE7

SOCKET SET SCHUKO DOUBLE HORIZONTAL IP44 2x 2P+E 16A 250V~
- screw contacts 1.5-2.5mm²
- 2x 2P+E schuko+cover horizontal
- 16A 250V~, type CF10
- in accordance with EN 60884-1, CEE7



- CF11PW
 CF11GY

КОМПЛЕКТ КОНТАКТИ ШУКО ДВОЙНИ ВЕРТИКАЛНИ IP44 2x 2P+E 16A 250V~

- винтови контакти 1,5 - 2,5 mm²
- 2x 2P+E шуко+капак вертикални
- 16A 250 V~, тип CF11
- в съответствие с EN 60884-1, CEE7

SOCKET SET SCHUKO DOUBLE VERTICAL IP44 2x 2P+E 16A 250V~
- screw contacts 1.5-2.5mm²
- 2x 2P+E schuko+cover vertical
- 16A 250V~, type CF11
- in accordance with EN 60884-1, CEE7



- CF12PW
 CF12GY

КОМПЛЕКТ КОНТАКТ ШУКО+КЛЮЧ ХОРИЗОНТАЛНИ 2WAY IP44 16A + 10AX 250V~

- винтове (контакта), чрез вкарване на проводниците (ключа) контакти 1,5 - 2,5 mm²
- 2P+E шуко+капак + ключ 2-way хоризонтални
- 16 A + 10AX 250 V~, тип CF12
- в съответствие с EN 60884-1, CEE7, EN 60669-1

SOCKET SCH+SWITCH SET 2WAY HORIZONTAL IP44 16A + 10AX 250V~
- screw (socket), plug-in (switch) contacts 1.5-2.5mm²
- 2P+E schuko+cover + switch 2-way horizontal
- 16A + 10AX 250V~, type CF12
- in accordance with EN 60884-1, CEE7, EN 60669-1



КОМПЛЕКТ КОНТАКТ ШУКО+КЛЮЧ ВЕРТИКАЛНИ IP44 16A + 10AX 250V~



- CF13PW
- CF13GY

- винтове (контакта), чрез вкарване на проводниците (ключа)
- контакти чрез вкарване 1,5 - 2,5 mm²
- 2P+E шуко+капак + ключ 2-way вертикални
- 16 A + 10AX 250 V~, тип CF13
- в съответствие с EN 60884-1, CEE7, EN 60669-1

SOCKET SCH+SWITCH 2WAY SET VERTICAL IP44 16A + 10AX 250V~

- screw (socket), plug-in (switch) contacts 1.5-2.5mm²
- 2P+E schuko+cover + switch 2-way vertical
- 16A + 10AX 250V~, type CF13
- in accordance with EN 60884-1, CEE7, EN 60669-1



КОМПЛЕКТ КОНТАКТИ ШУКО ДВОЙНИ ХОРИЗОНТАЛНИ IP44 2x 2P+E 16A 250V~ BV



- CF14PW
- CF14GY

- BV контакти чрез вкарване 1,5 - 2,5 mm²
- 2x 2P+E шуко+капак хоризонтални
- 16A 250 V~, тип CF14
- в съответствие с EN 60884-1, CEE7

SOCKET SET SCHUKO DOUBLE HORIZONTAL IP44 2x 2P+E 16A 250V~ BV

- BV plug-in contacts 1.5-2.5mm²
- 2x 2P+E schuko+cover horizontal
- 16A 250V~, type CF14
- in accordance with EN 60884-1, CEE7



КОМПЛЕКТ КОНТАКТИ ШУКО ДВОЙНИ ВЕРТИКАЛНИ IP44 2x 2P+E 16A 250V~ BV



- CF15PW
- CF15GY

- BV контакти чрез вкарване 1,5 - 2,5 mm²
- 2x 2P+E шуко+капак вертикални
- 16A 250 V~, тип CF15
- в съответствие с EN 60884-1, CEE7

SOCKET SET SCHUKO DOUBLE VERTICAL IP44 2x 2P+E 16A 250V~ BV

- BV plug-in contacts 1.5-2.5mm²
- 2x 2P+E schuko+cover vertical
- 16A 250V~, type CF15
- in accordance with EN 60884-1, CEE7



КОМПЛЕКТ КОНТАКТ ШУКО+КЛЮЧ ХОРИЗОНТАЛНИ 2WAY IP44 16A + 10AX 250V~ BV



- CF16PW
- CF16GY

- BV контакти чрез вкарване 1,5 - 2,5 mm²
- 2P+E шуко+капак + ключ 2-way хоризонтални
- 16 A + 10AX 250 V~, тип CF16
- в съответствие с EN 60884-1, CEE7, EN 60669-1

SOCKET+SWITCH SET SCH+2WAY HORIZONTAL IP44 16A + 10AX 250V~ BV

- BV plug-in contacts 1.5-2.5mm²
- 2P+E schuko+cover + switch 2-way horizontal
- 16A + 10AX 250V~, type CF16
- in accordance with EN 60884-1, CEE7, EN 60669-1



КОМПЛЕКТ КОНТАКТ ШУКО+КЛЮЧ 2WAY ВЕРТИКАЛНИ IP44 16A + 10AX 250V~ BV



- CF17PW
- CF17GY

- BV контакти чрез вкарване 1,5 - 2,5 mm²
- 2P+E шуко+капак + ключ 2-way вертикални
- 16 A + 10AX 250 V~, тип CF17
- в съответствие с EN 60884-1, CEE7, EN 60669-1

SOCKET SCH+SWITCH 2WAY SET VERTICAL IP44 16A + 10AX 250V~ BV

- BV plug-in contacts 1.5-2.5mm²
- 2P+E schuko+cover + switch 2-way vertical
- 16A + 10AX 250V~, type CF17
- in accordance with EN 60884-1, CEE7, EN 60669-1



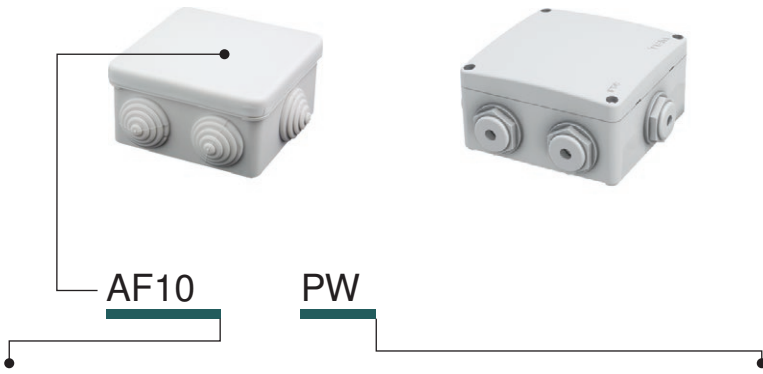

тип type	описание description	технически данни technical data	цвет colour
AF10	РАЗПРЕДЕЛИТЕЛНА КУТИЯ DISTRIBUTION BOX	IP44 RN01	<input type="checkbox"/> PW бял-матов white-mat
AF20	РАЗПРЕДЕЛИТЕЛНА КУТИЯ DISTRIBUTION BOX	IP55 NDO1	<input type="checkbox"/> GY сив-матов grey-mat

РАЗПРЕДЕЛИТЕЛНА КУТИЯ IP44 RN01



- AF10PW
- AF10GY

- разпределителна кутия за външен монтаж IP44
- 16 A 400 V~
- в съответствие с IEC/EN 60670-1, IEC/EN 60670-22

DISTRIBUTION BOX IP44 RN01

- surface mounting distribution box IP44
- 16A 400V~
- in accordance with IEC/EN 60670-1, IEC/EN 60670-22

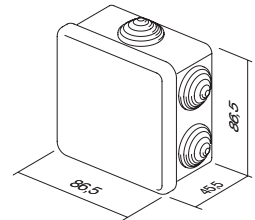

РАЗПРЕДЕЛИТЕЛНА КУТИЯ IP55 ND01



- AF20PW
- AF20GY

- съединителна кутия за външен монтаж IP55
- кабелните щучери са включени в доставката
- в съответствие с IEC/EN 60670-1, IEC/EN 60670-22

DISTRIBUTION BOX IP55 ND01

- surface mounting connection box IP55
- glands included
- in accordance with IEC/EN 60670-1, IEC/EN 60670-22

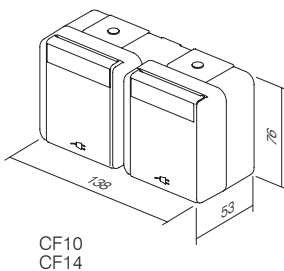
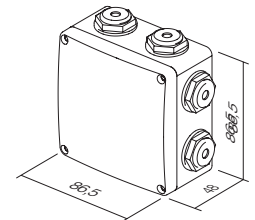

CF10
CF14

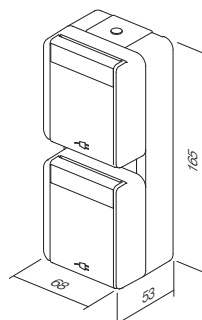

CF11
CF15

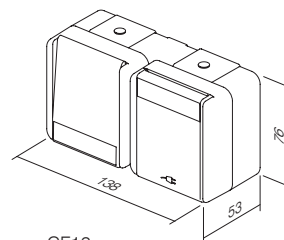

CF12
CF16

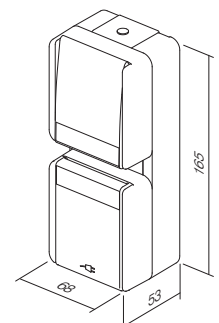

CF13
CF17

код	описание на продукта	страница
КЛЮЧОВЕ SM		
SM10	КЛЮЧ 1WAY 16AX 250V~ 1M	50
SM11	БУТОН 1WAY 16A 250V~ 1M	50
SM12	КЛЮЧ 1WAY 20A 250V~ 1M	50
SM20	КЛЮЧ 2POLE 16AX 250V~ 1M	50
SM40	КЛЮЧ ЗА ЩОРИ 1-0-2 16AX 250V~ 1M	51
SM41	БУТОН ЗА ЩОРИ 1-0-2 16A 250V~ 1M	51
SM60	КЛЮЧ 2WAY 16AX 250V~ 1M	51
SM61	БУТОН 2WAY 16A 250V~ 1M	51
SM70	КРЪСТАТ КЛЮЧ 16AX 250V~ 1M	51
SM10-	КЛЮЧ 1WAY 16AX 250V~ 1M	52
SM10-IN	КЛЮЧ 1WAY 16AX 250V~ 1M IN	52
SM11-	БУТОН 1WAY 16A 250V~ 1M	52
SM11-IN01	БУТОН 1WAY 16A 250V~ 1M IN 01	52
SM11-IN02	БУТОН 1WAY 16A 250V~ 1M IN 02	53
SM20-NT03	КЛЮЧ 2POLE 16AX 250V~ 1M NT 03	53
SM20-IN	КЛЮЧ 2POLE 16AX 250V~ 1M IN	53
SM40-NT10	КЛЮЧ ЗА ЩОРИ 1-0-2 16AX 250V~ 1M NT 10	53
SM41-NT10	БУТОН ЗА ЩОРИ1-0-2 16A 250V~ 1M NT 10	53
SM60-	КЛЮЧ 2WAY 16AX 250V~ 1M	53
SM61-	БУТОН 2WAY 16A 250V~ 1M	54
SM62-CD	БУТОН 2WAY С ШНУР 16A 250V~ 1M __ CD	54
SM70-	КРЪСТАТ КЛЮЧ 16AX 250V~ 1M	54

БУТОНИ ТМ		
TM11-	БУТОН 1M	55
TM11-IN	БУТОН 1M IN	55
TM12-	БУТОН 2M	55
TM12-IN	БУТОН 2M IN	55
TM13-IL	БУТОН 2M С ПАНЕЛ С НАДПИС	56
TM15-	БУТОН 1M 2POLE	56
TM21-	КАПАЧЕ 1M	56
TM22-	КАПАЧЕ 2M	56
TM31-	ИЗХОД ЗА КАБЕЛ 1M	56

СИГНАЛИЗАЦИЯ IA		
IA100R	НЕОНОВА ЛАМПА 230 V~ 0,34 W	58
IA20-	СВЕТОДИОДНА СИГНАЛИЗАЦИЯ 230 V AC/DC 0,4W	58
IA21-	СВЕТОДИОДНА СИГНАЛИЗАЦИЯ 24 V AC/DC 0,2W	58
IA22-	СВЕТОДИОДНА СИГНАЛИЗАЦИЯ 12V AC/DC 0,10W	58
IA50	RC ВЕРИГА 250 V	58

КОНТАКТИ VM		
VM10-	КОНТАКТ ШУКО+KS 2P+E 16A 250V~ 2M	60
VM11-	КОНТАКТ ШУКО+KS+КАПАК 2P+E 16A 250V~ 2M	60
VM20-	КОНТАКТ EURO+KS 2P 10A 250V~ 1M	61
VM40-	КОНТАКТ ФРЕНСКИ+KS 2P+E 16A 250V~ 2M	61
VM41-	КОНТАКТ ФРЕНСКИ+KS+КАПАК 2P+E 16A 250V~ 2M	61
VM30-	КОНТАКТ ИТАЛИАНСКИ P17/11+KS 2P+E 16A 250V~ 1M	61
VM31-	КОНТАКТ ШУКО/ИТАЛИАНСКИ P17/11+KS 2P+E 16A 250V~ 2M	61
VM32-	КОНТАКТ ШУКО/ИТАЛИАНСКИ P30+KS 2P+E 16A 250V~ 2M	62
VM33-	КОНТАКТ ИТАЛИАНСКИ P11+KS 2P+E 10A 250V~ 1M	62
VM21-	КОНТАКТ EURO/АМЕРИКАНСКИ+KS 2P 16A 250V~ 1M	62
VM52-	КОНТАКТ БРИТАНСКИ BS 1363+KS 2P+E 13A 250V~ 2M	62
VM55-	КОНТАКТ МУЛТИСТАНДАРТИЯТ+KS 2P+E 13A 250V~ 2M	62
VM80	УСТРОЙСТВО ЗА ЗАЩИТА СРЕЩУ ОТСКОЦИ НА НАПРЕЖЕНИЕТО MPE MINI 275V/50Hz	62

код	описание на продукта	страница
КОМУНИКАЦИИ КМ		
KM10-	КОНЕКТОР ЗА ТВ ОСНОВЕН 0 dB 1M	64
KM20-	КОНЕКТОР ЗА ТВ ОСНОВЕН 0 dB 2M	64
KM11-	КОНЕКТОР ЗА ТВ КРАЕН 1 dB 1M	64
KM12-	КОНЕКТОР ЗА ТВ ПРЕХОДЕН 10 dB 1M	64
KM15-	КОНЕКТОР ЗА САТЕЛИТНА ТВ ОСНОВЕН 0 dB 1M	65
KM24-	КОНЕКТОР ЗА САТЕЛИТНА ТВ ОСНОВЕН 0 dB 2M	65
KM16-	КОНЕКТОР ЗА САТЕЛИТНА ТВ КРАЕН 1 dB 1M	65
KM19-	КОНЕКТОР ЗА РАДИО ОСНОВЕН 0 dB 1M	65
KM29-	КОНЕКТОР ЗА РАДИО ОСНОВЕН 0 dB 2M	65
KM25-	КОНЕКТОР ЗА САТЕЛИТНА ТВ КРАЕН 1 dB 2M	65
KM22-	КОНЕКТОР ЗА АУДИОСИГНАЛИ 2xRCA 1M	66
KM23-	КОНЕКТОР ЗА ВИСОКОГОВОРТЕЛИ 1M	66
KM26-	КОНЕКТОР ЗА ВИСОКОГОВОРТЕЛИ 2M	66
KM30-	КОНЕКТОР ЗА ТЕЛЕФОН LT RJ11 6/4 1M	67
KM31-	КОНЕКТОР ЗА ТЕЛЕФОН BT SCH 6/6 1M	67
KM36-	КОНЕКТОР ЗА ТЕЛЕФОН KS RJ11 6/4 1M	67
KM37-	КОНЕКТОР CAT5e KS RJ45 8/8 1M	67
KM35-	АДАПТЕР KS 1M	67
KM38-	АДАПТЕР KS СЪС ЗАЩИТА ПРОТИВ ПРАХ 1M	67
KM39-	КОНЕКТОР CAT6 SCH KS RJ45 8/8 1M	68
KM50-	УНИВЕРСАЛЕН АДАПТЕР KS UNIVERSAL 1M	68
KM40-	АДАПТЕР PD 1M	68
KM43-	АДАПТЕР PD СЪС ЗАЩИТА ПРОТИВ ПРАХ 1M	68
KM46-	АДАПТЕР R&M 1M	68
KM52-	АДАПТЕР R&M CAT6A 1M	68
KM47-	АДАПТЕР R&M СЪС ЗАЩИТА ПРОТИВ ПРАХ 1M	69
KM53-	АДАПТЕР R&M CAT6A СЪС ЗАЩИТА ПРОТИВ ПРАХ 1M	69
KM45-	АДАПТЕР LK 1M	70
KA26	АДАПТЕР NEXANS/SCHRACK 2M	70
KM48-	АДАПТЕР AT&T SYSTIMAX СЪС ЗАЩИТА ПРОТИВ ПРАХ 1M	70
KM51-	КОНЕКТОР USB ТИП А 1M	70

КОМУНИКАЦИОННИ ПРИНАДЛЕЖНОСТИ КА		
KA10	КОНЕКТОР KS RJ11 RJ11 6/4	71
KA11	КОНЕКТОР KS CAT5e RJ45 8/8	71
KA12	КОНЕКТОР KS CAT5eS RJ45 8/8	71
KA15	КОНЕКТОР KS RJ45 SCHRACK RJ45 8/8	71
KA16	КОНЕКТОР KS RJ45 SCHRACK RJ45 8/8	71
KA17	КОНЕКТОР KS CAT6a SCHRACK RJ45 8/8	71
KA18	КОНЕКТОР KS RJ45 SCHRACK RJ45 8/8	72
KA27	КОНЕКТОР KS HDMI	72
KA28	КАБЕЛ KS HDMI	72

ЕЛЕКТРОНИКА ЕМ		
EM12-	ДИМЕР, ВЪРТЯЩ ТИП/2WAY RL 300W 1M	73
EM13-	ДИМЕР, ВЪРТЯЩ ТИП/2WAY LED 60W 1M	73
EM14-	ДИМЕР, ВЪРТЯЩ ТИП/2WAY LED 180W 1M	74
EM15-	ДИМЕР, ВЪРТЯЩ ТИП, R 250W 1M	74
EM16-	1 - 10 V ДИМЕР, ВЪРТЯЩ ТИП, ДВУПОСОЧЕН	75
EM23	ДИМЕР, ВГРАДЕН R (250 W), (RC, RL 200VA)	75
EM17	УПРАВЛЯВАЩ МОДУЛ MZC за EM18	76
EM18	ДИМЕРНО УСТРОЙСТВО ЗА СВЕТОДИОДИ 250W	76
EM19	ДИМЕРНО УСТРОЙСТВО ЗА СВЕТОДИОДИ, ПОСТОЯНЕН ТОК 96 W	77
EM25-	КЛЮЧ/УНИВЕРСАЛЕН ДИМЕР RLC 0-300W 2M	78
EM26-	БУТОННО УСТРОЙСТВО ЗА УПРАВЛЕНИЕ 2M	81
EM27	ЧЕСТОТЕН ФИЛТЪР	81
EM25PPOL20	КОМПЛЕКТ КЛЮЧ/УНИВЕРСАЛЕН ДИМЕР RLC 0-300W 2M PP OL20	81
EM31-	КЛЮЧ IR SWITCH 5A 230V~ 1M	82
EM32-	КЛЮЧ IR SWITCH 5A 230V~ 2M	82
EM37-	КЛЮЧ ОСНОВЕН 6A 230 V~ 2M	84
EM38-	ТЕРМОСТАТ ЗА ОТОПЛЕНИЕ 5(2) A 230 V~ 2M	85
EM39	ТЕРМОСТАТ ЗА ОТОПЛЕНИЕ/ОХЛАЖДАНЕ 3(1,5) A 230 V~ 2M	85
NM39	МОНТАЖНА РАМКА С ВИНТОВЕ ЗА ТЕРМОСТАТИ FANTINI COSMI 3M	86
EM40-	КЛЮЧ С КАРТА ЗА ИКОНОМИЯ НА ЕНЕРГИЯ ЗА 250V~ 3M	86
EM47	ISO КАРТА	86
EM44-	КЛЮЧ С КАРТА ЗА ИКОНОМИЯ НА ЕНЕРГИЯ RF HF 13,56 Mgz 3M	87
EM49	УСТРОЙСТВО ЗА УПРАВЛЕНИЕ ЗА ИКОНОМИЯ НА ЕНЕРГИЯ 2x16A 250V~	87
EM45	РАЗПРЕДЕЛИТЕЛ SPL-1	87
EM60-	КОНТАКТ ЗА САМОБЪРСНАЧКА 230V~/120V~ 3M	88
EM67-	USB ЗАХРАНВАЩО УСТРОЙСТВО 5 V 2,4 A 1M	88
EM68-	USB ЗАХРАНВАЩ БЛОК 5V 3,0A	89
EM55	СВЕТОДИОДНО АВАРИЙНО ОСВЕТЛЕНИЕ 250 V~ 0,90 W, NiCd 3h 7M	89
EM57	АВАРИЙНА СВЕТОДИОДНА ЛАМПА 230V~50 Hz, 0,5 W, NiMH 2h 2M	89
EM50-	LED АМБИЕНТАЛНА ЧАСТ ЕДНОЦВЕТНА 250V~ 0,8W 2M	90
EM51-	ДВУЦВЕТНА СВЕТОДИОДНА ЛАМПА 250V~ 2x0,4W 2M	90
EM52-	ДВУЦВЕТНА СВЕТОДИОДНА ЛАМПА 3D 250V~ 2x0,4W 2M	90
EM71-	ПРЕВКЛЮЧАТЕЛ С ПРЪСТОВ ОТПЕЧАТЪК BIOPASS 2M	91
EM82-	МУЛТИФУНКЦИОНАЛЕН ВРЕМЕВИ КЛЮЧ	92
EM80-	БЕЗКОНТАКТЕН КЛЮЧ, 10 A 240 V~	94
EM81-	БЕЗКОНТАКТЕН КЛЮЧ	94
EM90-	ЗУМЕР 8 VA 230 V~ 1M	95
EM91-	ЗУМЕР 8VA 12V~ 1M	95
EM92-	ЗВЪНЕЦ 8 VA 230 V~ 1M	95
EM93-	ЗУМЕР 8VA 12V~ 1M	95
EM94-	ЕЛЕКТРОНЕН ЗВЪНЕЦ 230V~ 6mA rms 1M	96
EM95-	РЕГУЛАТОР НА СИЛАТА НА ЗВУКА 100V AUDIO LINE 35W 2M	96
EM96-	РЕГУЛАТОР НА СИЛАТА НА ЗВУКА 4 - 8 Ω 35 W 2M	96

код	описание на продукта	страница
КОМПЛЕКТИ СМ		
SM10-	КОМПЛЕКТ КОНТАКТИ 2 x ШУКО 2P+E 16A 250V~ 4M	97
SM11-	КОМПЛЕКТ КОНТАКТИ 3 x ШУКО 2P+E 16A 250V~ 7M	97
SM15	КОМПЛЕКТ СЪЕДИНИТЕЛНИ ПРОВОДНИЦИ 3x1,5 mm2 1M	98
SM16	КОМПЛЕКТ СЪЕДИНИТЕЛНИ ПРОВОДНИЦИ 3x2,5 mm2 2M	98
SM17	КОМПЛЕКТ ВИНТОВЕ 3.5x20	98
SM18	КОМПЛЕКТ ВИНТОВЕ 3.5x35	98
SM19	КОМПЛЕКТ ВИНТОВЕ 3.5x50	98
SM22-	КОМПЛЕКТ КЛЮЧОВЕ IP44 2M	98
SM23-	КОМПЛЕКТ КОНТАКТИ IP44 2M	98
SM25-OL	КОМПЛЕКТ КЛЮЧ ЗА БАНЯ 3 x 20A 250 V~ 4M OL	98
SM25-OS	КОМПЛЕКТ КЛЮЧ ЗА БАНЯ 3 x 20A 250 V~ 4M OS	98
NM41	МОНТАЖНА РАМКА ЗА КОМПЛЕКТ ЗА БАНЯ 4M	99
OL41-	ПАНЕЛ LINE ЗА КОМПЛЕКТ ЗА БАНЯ	99
OS41-	ПАНЕЛ SOFT ЗА КОМПЛЕКТ ЗА БАНЯ	99
АНТИБАКТЕРИАЛНА ПРОГРАМА AW		
TM11AW	БУТОН 1M	101
TM11AWIN	БУТОН 1M IN	101
TM12AW	БУТОН 2M	101
TM12AWIN	БУТОН 2M IN	101
TM21AW	КАПАЧЕ 1M	101
TM22AW	КАПАЧЕ 2M	101
VM10AW	КОНТАКТ ШУКО+KS 2P+E 16A 250V~ 2M	102
VM11AW	КОНТАКТ ШУКО+KS+КАПАК 2P+E 16A 250V~ 2M	102
VM20AW	КОНТАКТ EURO+KS 2P 10A 250V~ 1M	102
KM11AW	КОНЕКТОР ЗА ТВ КРАЕН 1 dB 1M	102
KM35AW	АДАПТЕР KS 1M	102
OS20AW	ПАНЕЛ SOFT 2M	103
OS24AW	ПАНЕЛ SOFT 2x2M	103
OS26AW	ПАНЕЛ SOFT 3x2M	103
OS30AW	ПАНЕЛ SOFT 3M	103
OS40AW	ПАНЕЛ SOFT 4M	103
OS70AW	ПАНЕЛ SOFT 7M	103
ПАНЕЛИ PURE OP		
OP20-	ПАНЕЛ PURE 2M	106
OP24-	ПАНЕЛ PURE 2x2M	106
OP26-	ПАНЕЛ PURE 3x2M	106
OP28-	ПАНЕЛ PURE 4x2M	106
OP30-	ПАНЕЛ PURE 3M	107
OP40-	ПАНЕЛ PURE 4M	107
OP70-	ПАНЕЛ PURE 7M	107
OP13-	ПАНЕЛ PURE 1/3M	107
OP23-	ПАНЕЛ PURE 2/3M	107
ПРОДУКТОВА ГАМА ПАНЕЛИ OL		
OL20-	ПАНЕЛ LINE 2M	110
OL24-	ПАНЕЛ LINE 2x2M	110
OL26-	ПАНЕЛ LINE 3x2M	110
OL28-	ПАНЕЛ LINE 4x2M	110
OL29-	ПАНЕЛ LINE 5x2M	110
OL30-	ПАНЕЛ LINE 3M	111
OL40-	ПАНЕЛ LINE 4M	111
OL70-	ПАНЕЛ LINE 7M	111
OL71-	ПАНЕЛ LINE 2x7M	111
OL10-	ПАНЕЛ LINE 1/2M	111
OL13-	ПАНЕЛ LINE 1/3M	111
OL23-	ПАНЕЛ LINE 2/3M	111
ПАНЕЛИ SOFT OS		
OS20-	ПАНЕЛ SOFT 2M	114
OS24-	ПАНЕЛ SOFT 2x2M	114
OS26-	ПАНЕЛ SOFT 3x2M	114
OS28-	ПАНЕЛ SOFT 4x2M	114
OS30-	ПАНЕЛ SOFT 3M	115
OS40-	ПАНЕЛ SOFT 4M	115
OS70-	ПАНЕЛ SOFT 7M	115
OS71-	ПАНЕЛ SOFT 2x7M	115
OS72-	ПАНЕЛ SOFT 2x7M	115
OS10-	ПАНЕЛ SOFT 1/2M	116
OS13-	ПАНЕЛ SOFT 1/3M	116
OS23-	ПАНЕЛ SOFT 2/3M	116
МОНТАЖНИ РАМКИ NM		
NM20	МОНТАЖНА РАМКА С КРАЧЕТА 2M	120
NM21	МОНТАЖНА РАМКА БЕЗ ВИНТОВЕ 2M	120
NM24	МЕТАЛНА МОНТАЖНА РАМКА С КРАЧЕТА 2M	120
NM25	МЕТАЛНА МОНТАЖНА РАМКА БЕЗ ВИНТОВЕ 2M	120
NM10	МОНТАЖНА РАМКА С КРАЧЕТА 1/2M	121
NM11	МОНТАЖНА РАМКА БЕЗ ВИНТОВЕ 1/2M	121
NM23	МОНТАЖНА РАМКА С КРАЧЕТА 2/3M	121
NM30	МЕТАЛНА МОНТАЖНА РАМКА С ВИНТОВЕ 3M	122
NM40	МЕТАЛНА МОНТАЖНА РАМКА С ВИНТОВЕ 4M	122
NM70	МЕТАЛНА МОНТАЖНА РАМКА С ВИНТОВЕ 7M	122
NM72	МЕТАЛНА МОНТАЖНА РАМКА С ВИНТОВЕ 2x7M	122
NM32	МЕТАЛНА МОНТАЖНА РАМКА С ВИНТОВЕ 2/3M	122

КУТИИ

код	описание на продукта	страница
КРЪГЛИ КОНЗОЛИ		
DE10	КРЪГЛА КОНЗОЛА ЗА ТУХЛЕНИ СТЕНИ SM60-01	126
DE11	КРЪГЛА КОНЗОЛА ЗА ТУХЛЕНИ СТЕНИ, ДЪЛБОКА SM60-06	126
DE30	СОМБИ-CLIP SM60-03	126
DE31	СОМБИ-CLIP SM60-04	126
DE12	КРЪГЛА КОНЗОЛА ЗА ТУХЛЕНИ СТЕНИ 65-46	127
DE13	КРЪГЛА КОНЗОЛА ЗА ТУХЛЕНИ СТЕНИ 65-60	127
DE14	ДОПЪЛНИТЕЛЕН ДЕТАЙЛ ЗА MD 65-46	127
DE32	СОМБИ-CLIP MD 65-71	127
DE33	СОМБИ-CLIP MD 65-91	127
DE20	ЗАЩИТЕН КАПАК ЗА КОНЗОЛА 60	127
DE21	ЗАЩИТЕН КАПАК ЗА КОНЗОЛА 65	127
DE22	ДЕКОРАТИВЕН КАПАК ЗА КОНЗОЛА SM60	127
HE10	КРЪГЛА КОНЗОЛА ЗА ТУХЛЕНИ СТЕНИ SM68x40	130
HE11	КРЪГЛА КОНЗОЛА ЗА ТУХЛЕНИ СТЕНИ SM68x55	130
BE10	КРЪГЛА КОНЗОЛА ЗА СТЕНИ ОТ БЕТОН 60-49	130
BE11	КРЪГЛА КОНЗОЛА ЗА СТЕНИ ОТ БЕТОН 60-77	130
BE20	ЗАДНА ОПОРА ЗА КОНЗОЛА ЗА СТЕНИ ОТ БЕТОН	130
BE21	ОГРАНИЧИТЕЛ ЗА ТРЪЧИ ЗА КОНЗОЛИ ЗА СТЕНИ ОТ БЕТОН 16	130
ПРАВОЪГЪЛНИ КОНЗОЛИ		
DM30	ПРАВОЪГЪЛНА КОНЗОЛА ЗА ТУХЛЕНИ СТЕНИ PM3	134
DM31	ПРАВОЪГЪЛНА КОНЗОЛА ЗА ТУХЛЕНИ СТЕНИ PM3-65	134
DM40	ПРАВОЪГЪЛНА КОНЗОЛА ЗА ТУХЛЕНИ СТЕНИ PM4	134
DM41	ПРАВОЪГЪЛНА КОНЗОЛА ЗА ТУХЛЕНИ СТЕНИ PM4-65	134
DM70	ПРАВОЪГЪЛНА КОНЗОЛА ЗА ТУХЛЕНИ СТЕНИ PM7	135
DM71	ПРАВОЪГЪЛНА КОНЗОЛА ЗА ТУХЛЕНИ СТЕНИ PM7-65	135
DM72	ПРАВОЪГЪЛНА КОНЗОЛА ЗА ТУХЛЕНИ СТЕНИ PM72-65	135
DM80	ДИСТАНЦИОНЕН ЕЛЕМЕНТ ЗА КОНЗОЛА PM	135
DM33	ЗАЩИТЕН КАПАК ЗА КОНЗОЛА PM3	136
DM34	ДЕКОРАТИВЕН КАПАК ЗА КОНЗОЛА PM3	136
DM43	ЗАЩИТЕН КАПАК ЗА КОНЗОЛА PM4	136
DM44	ДЕКОРАТИВЕН КАПАК ЗА КОНЗОЛА PM4	136
DM73	ЗАЩИТЕН КАПАК ЗА КОНЗОЛА PM7	136
DM74	ДЕКОРАТИВЕН КАПАК ЗА КОНЗОЛА PM7	136
DM75	ДЕКОРАТИВЕН КАПАК ЗА КОНЗОЛА PM72	137
NM30	ПРАВОЪГЪЛНА КОНЗОЛА ЗА КУХИ СТЕНИ VM3	138
NM40	ПРАВОЪГЪЛНА КОНЗОЛА ЗА КУХИ СТЕНИ VM4	138
NM70	ПРАВОЪГЪЛНА КОНЗОЛА ЗА КУХИ СТЕНИ VM7	138
NM72	ПРАВОЪГЪЛНА КОНЗОЛА ЗА КУХИ СТЕНИ VM72	138
VM30	ПРАВОЪГЪЛНА КОНЗОЛА ЗА СТЕНИ ОТ БЕТОН VM3	139
VM40	ПРАВОЪГЪЛНА КОНЗОЛА ЗА СТЕНИ ОТ БЕТОН VM4	139
VM70	ПРАВОЪГЪЛНА КОНЗОЛА ЗА СТЕНИ ОТ БЕТОН VM7	139
VM80	FIXING СОМБИ-CLIP VM	139
VM82	ДИСТАНЦИОНЕН ЕЛЕМЕНТ ЗА КОНЗОЛИ VM	139
СЪЕДИНИТЕЛНИ КУТИИ		
DW10	КРЪГЛА СЪЕДИНИТЕЛНА КОНЗОЛА ЗА ТУХЛЕНИ СТЕНИ DSM78	142
NW10	КРЪГЛА СЪЕДИНИТЕЛНА КОНЗОЛА ЗА КУХИ СТЕНИ SM78x45	142
DE23	ДЕКОРАТИВЕН КАПАК ЗА КОНЗОЛА SM78	142
DE24	ЗАЩИТЕН КАПАК ЗА КОНЗОЛА 78	142
NW20	КВАДРАТНА СЪЕДИНИТЕЛНА КОНЗОЛА ЗА ТУХЛЕНИ СТЕНИ SM105x105	142
ПРИНАДЛЕЖНОСТИ ЗА СВЪРЗВАНЕ		
UW10-	1 РЕД КЛЕМОРЕДИ ЗАТВОРЕНИ PC 2x2,5 mm ² 10P	144
UW11-	1 РЕД КЛЕМОРЕДИ ЗАТВОРЕНИ PC 2x4 mm ² 10P	144
UW12-	1 РЕД КЛЕМОРЕДИ ЗАТВОРЕНИ PC 2x6 mm ² 10P	144
UW15-	1 РЕД КЛЕМОРЕДИ PA 2x2,5 mm ² 12P	144
UW16-	1 РЕД КЛЕМОРЕДИ PA 2x4 mm ² 12P	144
UW17-	1 РЕД КЛЕМОРЕДИ PA 2x6 mm ² 12P	144
UW29-	2 РЕДА КЛЕМОРЕДИ PP 1,0-4,0 mm ² 12P	144
UW30-	2 РЕДА КЛЕМОРЕДИ PP 1,5-6,0 mm ² 12P	144
UW31-	2 РЕДА КЛЕМОРЕДИ PP 2,5-10 mm ² 12P	144
UW32-	2 РЕДА КЛЕМОРЕДИ PP 4,0-16 mm ² 12P	144
UW25-	2 РЕДА КЛЕМОРЕДИ PA 1,0-4,0 mm ² 12P	145
UW26-	2 РЕДА КЛЕМОРЕДИ PA 1,5-6,0 mm ² 12P	145
UW27-	2 РЕДА КЛЕМОРЕДИ PA 2,5-10 mm ² 12P	145
UW28-	2 РЕДА КЛЕМОРЕДИ PA 4,0-16 mm ² 12P	145
UW40-	СЪЕДИНИТЕЛИ С ВКАРВАНЕ НА ПРОВОДНИЦИТЕ PA 1,5 mm ² 3P	145
UW41-	СЪЕДИНИТЕЛИ С ВКАРВАНЕ НА ПРОВОДНИЦИТЕ PA 1,5 mm ² 5P	145
UW42-	СЪЕДИНИТЕЛИ С ВКАРВАНЕ НА ПРОВОДНИЦИТЕ PA 1,5 mm ² 8P	145
UW45-	СЪЕДИНИТЕЛИ С ВКАРВАНЕ НА ПРОВОДНИЦИТЕ PA 2,5 mm ² 3P	145
UW46-	СЪЕДИНИТЕЛИ С ВКАРВАНЕ НА ПРОВОДНИЦИТЕ PA 2,5 mm ² 4P	145
UW47-	СЪЕДИНИТЕЛИ С ВКАРВАНЕ НА ПРОВОДНИЦИТЕ PA 2,5 mm ² 5P	145
UW50-	СЪЕДИНИТЕЛИ С ВКАРВАНЕ НА ПРОВОДНИЦИТЕ PA 2,5 mm ² 2/1P	145

код	описание на продукта	страница
КОНЗОЛИ СУВО IP20 AC		
AC11-	КОНЗОЛА NO СУВО СЪС ЗАДЕН КАПАК IP20 1M	148
AC21-	КОНЗОЛА NO СУВО СЪС ЗАДЕН КАПАК IP20 2M	148
AC41-	КОНЗОЛА NO СУВО СЪС ЗАДЕН КАПАК IP20 4M	148
AC61-	КОНЗОЛА NO СУВО СЪС ЗАДЕН КАПАК IP20 6M	148
КОНЗОЛИ СУВО IP55 AQ		
AQ20-	КОНЗОЛА NO СУВО IP55 2M	149
AQ22-	КОНЗОЛА NO СУВО IP55 2x2M	149
AQ30-	КОНЗОЛА NO СУВО IP55 3M	149
AQ21-	КУТИЯ PO СУВО IP55 2M	150
AQ31-	КОНЗОЛА PO СУВО IP55 3M	150
СИСТЕМА ЗА КАНАЛ ЗА КАБЕЛИ МА		
RT10	АДАПТЕР МА 162	151
RT12-	ПАНЕЛ МА 92 2/3M	151
RT14-	ПАНЕЛ МА 162 4M	151
RT17-	ПАНЕЛ МА 162 7M	151
RT20-	ОСНОВА ЗА КАНАЛ МА 130x65	152
RT21-	ОСНОВА ЗА КАНАЛ МА 165x65	152
RT25	ПРЕДЕН КАПАК МА 92	152
RT30	КАБЕЛНА СКАРА МА 43	152
RT31	КАБЕЛНА СКАРА МА 43 AL	152
RT32	КАБЕЛНА СКАРА МА 43 AL ДВОЙНА	152
RT35-	КРАЕН ЕЛЕМЕНТ МА 130x65	153
RT36-	КРАЕН ЕЛЕМЕНТ МА 165x65	153
RT38	КОМПЛЕКТ СЪЕДИНИТЕЛЕН ЕЛЕМЕНТ МА 65	153
RT40-	УНИВЕРСАЛЕН ЪГЛОВ ЕЛЕМЕНТ МА 130x65	153
RT41-	УНИВЕРСАЛЕН ЪГЛОВ ЕЛЕМЕНТ МА 165x65	153
RT42	ЗАЗЕМИТЕЛЕН ЕЛЕМЕНТ МА 2x A6.3	153
RT43-	ЛКОЛЯНО МА 130x65 / 130	153
RT44-	ЛКОЛЯНО МА 165x65 / 130	154
RT47-	ЛКОЛЯНО МА 165x65 / 165	154
RT45-	Т-КОЛЯНО МА 130x65 / 130	154
RT46-	Т-КОЛЯНО МА 165x65 / 130	154
RT48-	Т-КОЛЯНО МА 165x65 / 165	154
RT50-	ЕДИНИЧНА ЗАКРЕПВАЩА ПЛАСТИНА МА 130x65	155
RT51-	ДВОЙНА ЗАКРЕПВАЩА ПЛАСТИНА МА 130x65	155
RT52-	СЕРВИЗНА КОЛОНА МА 130x65x500	155
RT53-	ДВОЙНА СЕРВИЗНА КОЛОНА МА 130x65x500	155
ПОДОВИ КОНЗОЛИ MT		
RB50	ОСНОВА ЗА ПОДОВА КОНЗОЛА 4M	157
RB60	ВЛОЖКА ЗА ПОДОВА РАЗПРЕДЕЛИТЕЛНА КОНЗОЛА 4M	157
RB65S1	КАПАК ЗА ПОДОВА РАЗПРЕДЕЛИТЕЛНА КОНЗОЛА 4M	157
RB51	ОСНОВА ЗА ПОДОВА КОНЗОЛА 7M	157
RB61	ВЛОЖКА ЗА ПОДОВА РАЗПРЕДЕЛИТЕЛНА КОНЗОЛА 7M	157
RB66S1	КАПАК ЗА ПОДОВА РАЗПРЕДЕЛИТЕЛНА КОНЗОЛА 7M	157
RB52	ОСНОВА ЗА ПОДОВА КОНЗОЛА 2X7M	158
RB62	ВЛОЖКА ЗА ПОДОВА РАЗПРЕДЕЛИТЕЛНА КОНЗОЛА 2X7M	158
RB67S2	КАПАК ЗА ПОДОВА РАЗПРЕДЕЛИТЕЛНА КОНЗОЛА 2X7M	158
RB53	ОСНОВА ЗА ПОДОВА КОНЗОЛА 4X7M	158
RB62	ВЛОЖКА ЗА ПОДОВА РАЗПРЕДЕЛИТЕЛНА КОНЗОЛА 2X7M	158
RB68S2	КАПАК ЗА ПОДОВА РАЗПРЕДЕЛИТЕЛНА КОНЗОЛА 4X7M	158
RB55S1	ПОДОВА КОНЗОЛА С КАПАК ЗА ДВОЕН ПОД 4M	159
RB60	ВЛОЖКА ЗА ПОДОВА РАЗПРЕДЕЛИТЕЛНА КОНЗОЛА 4M	159
RB56S1	ПОДОВА КОНЗОЛА С КАПАК ЗА ДВОЕН ПОД 7M	160
RB61	ВЛОЖКА ЗА ПОДОВА РАЗПРЕДЕЛИТЕЛНА КОНЗОЛА 7M	160
RB57S2	ПОДОВА КОНЗОЛА С КАПАК ЗА ДВОЕН ПОД 2X7M	160
RB62	ВЛОЖКА ЗА ПОДОВА РАЗПРЕДЕЛИТЕЛНА КОНЗОЛА 2X7M	160
RB58S2	ПОДОВА КОНЗОЛА С КАПАК ЗА ДВОЕН ПОД 4X7M	160
RB62	ВЛОЖКА ЗА ПОДОВА РАЗПРЕДЕЛИТЕЛНА КОНЗОЛА 2X7M	160
RB10	АДАПТЕР ЗА DIN РЕЛСА 35mm 1M	161
RB11	АДАПТЕР ЗА DIN РЕЛСА 35mm 2M	161

код	описание на продукта	страница
КЛЮЧОВЕ SQ		
SQ10-XO	КЛЮЧ 1WAY 10AX 250V~	174
SQ10-INXO	КЛЮЧ 1WAY 10AX 250V~ __ IN	174
SQ11-XO	БУТОН 1WAY 10A 250V~	174
SQ11-IN01XO	БУТОН 1WAY 10A 250V~ __ IN 01	174
SQ11-IN02XO	БУТОН 1WAY 10A 250V~ __ IN 02	175
SQ22-IN03XO	КЛЮЧ 2POLE 16AX 250V~ __ IN 03	175
SQ50-XO	КЛЮЧ 2GANG-1WAY 10AX 250V~	175
SQ51-XO	БУТОН 2GANG-1WAY 10A 250V~	175
SQ52-NT09XO	КЛЮЧ ЗА ЩОРИ 10AX 250V~ __ NT 09	175
SQ53-NT09XO	БУТОН ЗА ЩОРИ 10A 250V~ __ NT 09	175
SQ60-XO	КЛЮЧ 2WAY 10AX 250V~	175
SQ63-XO	ДВОЕН КЛЮЧ 2WAY 10AX 250V~	176
SQ70-XO	КРЪСТАТ КЛЮЧ 10AX 250V~	176
СИГНАЛИЗАЦИЯ IA		
IA10-	НЕОНОВА ЛАМПА 230 V~ 0,34 W	177
IA20-	СВЕТОДИОДНА СИГНАЛИЗАЦИЯ 230V ~ AC/DC 0,4W	177
IA21-	СВЕТОДИОДНА СИГНАЛИЗАЦИЯ 24 V AC/DC 0,2W	177
IA22-	СВЕТОДИОДНА СИГНАЛИЗАЦИЯ 12 V AC/DC 0,1W	177
КОНТАКТИ VQ		
VQ10-XO	КОНТАКТ ШУКО 2P+E 16A 250V~ __ XO	180
VQ11-XO	КОНТАКТ ШУКО+КАПАК 2P+E 16A 250V~ __ XO	180
VQ12-XO	КОНТАКТ ШУКО 2P+E 16A 250V~ BV __ XO	180
VQ13-XO	КОНТАКТ ШУКО+КАПАК 2P+E 16A 250V~ BV __ XO	180
VQ16-	КОНТАКТ ШУКО ДВОЕН 2P+E 16A 250V~	180
VQ40-XO	КОНТАКТ ФРЕНСКИ 2P+E 16A 250V~ __ XO	181
VQ41-XO	КОНТАКТ ФРЕНСКИ+КАПАК 2P+E 16A 250V~ __ XO	181
VQ42-XO	КОНТАКТ ФРЕНСКИ 2P+E 16A 250V~ BV __ XO	181
VQ43-XO	КОНТАКТ ФРЕНСКИ+КАПАК 2P+E 16 A 250 V~ BV __ XO	181
VQ46-XO	КОНТАКТ ФРЕНСКИ ДВОЕН 2P+E 16A 250V~	181
КОМУНИКАЦИИ KQ		
KQ10-XO	КОНТАКТ ЗА ТВ БА30B 0 dB	182
KQ11-XO	КОНТАКТ ЗА ТВ-РАДИО КРАЕН 1 dB	182
KQ12-XO	КОНТАКТ ЗА ТВ-РАДИО ПРЕХОДЕН 10 dB	182
KQ16-XO	КОНТАКТ ЗА САТЕЛИТНА ТВ-РАДИО КРАЕН 3 dB	182
KQ22-XO	КОНТАКТ ЗА АУДИОСИГНАЛИ 2xRCA	183
KQ23-XO	КОНТАКТ ЗА ВИСОКОГОВОРИТЕЛИ	183
KQ36-XO	КОНЕКТОР ЗА ТЕЛЕФОН KS RJ11 6/4	183
KQ37-XO	КОНЕКТОР CAT5e KS RJ45 8/8	183
KQ38-XO	КОНЕКТОР ЗА ТЕЛЕФОН KS ДВОЕН 2x RJ11 6/4	183
KQ39-XO	КОНЕКТОР CAT5e KS ДВОЕН 2x RJ45 8/8	183
KQ35-XO	КОНЕКТОР ЗА ТЕЛЕФОН LT RJ11 6/4	183
KQ40-XO	КОНЕКТОР CAT6s KS ДВОЕН 2x RJ45 8/8 SLIM	184
KQ41-XO	КОНЕКТОР CAT6s KS ДВОЕН 2x RJ45 8/8 SLIM	184
ЕЛЕКТРОНИКА EQ		
EQ15-XO	ДИМЕР, ВЪРТЯЩ ТИП, ДВУПОСОЧЕН, АКТИВЕН/ИНДУКТИВЕН ТОВАР 400W	185
EQ16-XO	ДИМЕР, ВЪРТЯЩ ТИП, ДВУПОСОЧЕН, АКТИВЕН/ИНДУКТИВЕН/КАПАЦИТИВЕН ТОВАР 400W	185
EQ19-XO	ДИМЕР, ВЪРТЯЩ ТИП, ДВУПОСОЧЕН, ЗА СВЕТОДИОДНО ОСВЕТЛЕНИЕ 100W	185
EQ32-XO	КЛЮЧ IR 5A 230V~	187
EQ35-XO	ОТОПЛЕНИЕ С ТЕРМОСТАТ 10A 230V~	187
EQ36-XO	ОТОПЛЕНИЕ/ОХЛАЖДАНЕ С ТЕРМОСТАТ 5A 230V~	187
EQ37-XO	ПОДОВО ОТОПЛЕНИЕ С ТЕРМОСТАТ 16A 230V~	188
EQ68-XO	USB ЗАХРАНВАЩО УСТРОЙСТВО 5V 3.0A	188
КАПАЦИ PQ		
PQ10-XO	КАПАЧЕ	189
PQ30-	ПАНЕЛ TAE/TDO	189
РАМКИ OQ		
OQ10-	ПАНЕЛ LOGIQ 1	190
OQ20-	ПАНЕЛ LOGIQ 2	190
OQ30-	ПАНЕЛ LOGIQ 3	191
OQ40-	ПАНЕЛ LOGIQ 4	191
OQ50-	ПАНЕЛ LOGIQ 5	191

код	описание на продукта	страница
КЛЮЧОВЕ SE		
SE10	КЛЮЧ 1WAY 10AX 250V~	202
SE11	БУТОН 1WAY 10A 250V~	202
SE22	КЛЮЧ 2POLE 16AX 250V~	202
SE50	КЛЮЧ 2GANG-1WAY 10AX 250V~	202
SE51	БУТОН 2GANG-1WAY 10A 250V~	203
SE52	КЛЮЧ ЗА ЩОРИ 10AX 250V~	203
SE53	БУТОН ЗА ЩОРИ 10A 250V~	203
SE60	КЛЮЧ 2WAY 10AX 250V~	203
SE63	ДВОЕН КЛЮЧ 2WAY 10AX 250V~	203
SE70	КРЪСТАТ КЛЮЧ 10AX 250V~	203
SE10-	КЛЮЧ 1WAY 10AX 250V~	204
SE10-IN	КЛЮЧ 1WAY 10AX 250V~ IN	204
SE11-	БУТОН 1WAY 10A 250V~	204
SE11-TI50	БУТОН 1WAY 10A 250V~ TI 50	204
SE11-TI51	БУТОН 1WAY 10A 250V~ TI 51	204
SE11-IL	БУТОН 1WAY 10A 250V~ IL	204
SE22-IN03	КЛЮЧ 2POLE 16AX 250V~ IN 03	204
SE50-	КЛЮЧ 2GANG-1WAY 10AX 250V~	205
SE51-	БУТОН 2GANG-1WAY 10A 250V~	205
SE52-NT09	КЛЮЧ ЗА ЩОРИ 10AX 250V~ NT 09	205
SE53-NT09	БУТОН ЗА ЩОРИ 10A 250V~ NT 09	205
SE60-	КЛЮЧ 2WAY 10AX 250V~	205
SE63-	ДВОЕН КЛЮЧ 2WAY 10AX 250V~	205
SE70-	КРЪСТАТ КЛЮЧ 10AX 250V~	205
БУТОНИ ТЕ		
TE10-	БУТОН 1GANG	206
TE10-IN	БУТОН С ИНДИКАТОР	206
TE13-IL	БУТОН С ПАНЕЛ С НАДПИС IL	206
TE11-	БУТОН 2GANG	206
СИГНАЛИЗАЦИЯ IA		
IA10-	НЕОНОВА ЛАМПА 230 V~ 0,34 W	207
IA20-	СВЕТОДИОДНА СИГНАЛИЗАЦИЯ 230V ~ AC/DC 0,4W	207
IA21-	СВЕТОДИОДНА СИГНАЛИЗАЦИЯ 24 V AC/DC 0,2W	207
IA22-	СВЕТОДИОДНА СИГНАЛИЗАЦИЯ 12 V AC/DC 0,1W	207
КОНТАКТИ VE		
VE10-XO	КОНТАКТ ШУКО 2P+E 16A 250V~ XO	210
VE11-XO	КОНТАКТ ШУКО+КАПАК 2P+E 16A 250V~ XO	210
VE12-XO	КОНТАКТ ШУКО 2P+E 16A 250V~ BV XO	210
VE13-XO	КОНТАКТ ШУКО+КАПАК 2P+E 16A 250V~ BV XO	210
VE10-	КОНТАКТ ШУКО 2P+E 16A 250V~	210
VE11-	КОНТАКТ ШУКО+КАПАК 2P+E 16A 250V~	210
VE12-	КОНТАКТ ШУКО 2P+E 16A 250V~ BV	210
VE13-	КОНТАКТ ШУКО+КАПАК 2P+E 16A 250V~ BV	210
VE40-XO	КОНТАКТ ФРЕНСКИ 2P+E 16A 250V~ XO	211
VE41-XO	КОНТАКТ ФРЕНСКИ+КАПАК 2P+E 16A 250V~ XO	211
VE42-XO	КОНТАКТ ФРЕНСКИ 2P+E 16A 250V~ BV XO	211
VE43-XO	КОНТАКТ ФРЕНСКИ+КАПАК 2P+E 16A 250V~ BV XO	211
VE40-	КОНТАКТ ФРЕНСКИ 2P+E 16A 250V~	211
VE41-	КОНТАКТ ФРЕНСКИ+КАПАК 2P+E 16A 250V~	211
VE42-	КОНТАКТ ФРЕНСКИ 2P+E 16A 250V~ BV	211
VE43-	КОНТАКТ ФРЕНСКИ+КАПАК 2P+E 16A 250V~ BV	211
VE16-	ДВОЕН КОНТАКТ ШУКО 2P+E 16A 250V~	212
VE46-	ДВОЕН КОНТАКТ ФРЕНСКИ 2P+E 16A 250V~	212
VE30-	КОНТАКТ 2P 16A 250V~	212
КОМУНИКАЦИИ KE		
KE11	КОНЕКТОР ЗА ТВ-РАДИО КРАЕН 1 dB	213
KE12	КОНЕКТОР ЗА ТВ-РАДИО ПРЕХОДЕН 10 dB	213
KE16	КОНЕКТОР ЗА САТЕЛИТНА ТВ-РАДИО КРАЕН 3 dB	213
KE36	КОНЕКТОР TEL KS RJ11 6/4	213
KE37	КОНЕКТОР CAT5e KS RJ45 8/8	214
KE40	КОНЕКТОР CAT6s KS RJ45 8/8 SLIM	214
KE38	ДВОЕН КОНЕКТОР TEL KS 2x RJ11 6/4	214
KE39	ДВОЕН КОНЕКТОР CAT5e KS 2x RJ45 8/8	214
KE41	ДВОЕН КОНЕКТОР CAT6s KS 2x RJ45 8/8 SLIM	214
KE45	ЕДИНИЧЕН АДАПТЕР KS	214
KE46	ДВОЕН АДАПТЕР KS	215
KE47	ДВОЕН АДАПТЕР PD	215
KE10-	КОНЕКТОР ЗА ТВ ОСНОВЕН 0 dB	216
KE11-	КОНЕКТОР ЗА ТВ-РАДИО КРАЕН 1 dB	216
KE12-	КОНЕКТОР ЗА ТВ-РАДИО ПРЕХОДЕН 10 dB	216
KE16-	КОНЕКТОР ЗА САТЕЛИТНА ТВ-РАДИО КРАЕН 3 dB	216
KE22-	КОНЕКТОР ЗА АУДИОСИГНАЛИ 2xRCA	216
KE23-	КОНЕКТОР ЗА ВИСОКОГОВОРИТЕЛИ	216
KE36-	КОНЕКТОР TEL KS RJ11 6/4	216
KE37-	КОНЕКТОР CAT5e KS RJ45 8/8	217
KE40-	КОНЕКТОР CAT6s KS RJ45 8/8 SLIM	217
KE38-	ДВОЕН КОНЕКТОР TEL KS 2x RJ11 6/4	217
KE39-	ДВОЕН КОНЕКТОР CAT5e KS 2x RJ45 8/8	217
KE41-	ДВОЕН КОНЕКТОР CAT6s KS 2x RJ45 8/8 SLIM	217
KE35-	КОНЕКТОР TEL LT RJ11 6/4	217

код	описание на продукта	страница
КАПАЦИ РЕ		
PE10-	ПАНЕЛ ЗА ТВ-РАДИО 2P/3P	218
PE20-	ЕДИНИЧЕН ПАНЕЛ KS	218
PE21-	ДВОЕН ПАНЕЛ KS	218
PE30-	ПАНЕЛ TAE/TDO	218
ЕЛЕКТРОНИКА ЕЕ		
EE15	ДИМЕР, ВЪРТЯЩ ТИП ДВУПОСОЧЕН RL 400 W	219
EE16	ДИМЕР, ВЪРТЯЩ ТИП ДВУПОСОЧЕН RLC 400 W	219
EE19	ДИМЕР, ВЪРТЯЩ ТИП ДВУПОСОЧЕН RLC 100 W	220
EE32	ДИМЕР, ВЪРТЯЩ ТИП ДВУПОСОЧЕН RLC 100 W	220
EE67	USB ЗАХРАНВАЩ БЛОК 5V 2,4A	220
EE15-	ДИМЕР, ВЪРТЯЩ ТИП ДВУПОСОЧЕН RL 400 W	221
EE16-	ДИМЕР, ВЪРТЯЩ ТИП ДВУПОСОЧЕН RLC 400 W	221
EE19-	ДИМЕР, ВЪРТЯЩ ТИП ДВУПОСОЧЕН RLC 100 W	221
EE32-	КЛЮЧ IR 5A 230V~	221
EE67-	USB ЗАХРАНВАЩ БЛОК 5V 2,4A	222
ПАНЕЛИ ЗА ЕЛЕКТРОНИКА РЕ		
PE41-	ПАНЕЛ ЗА ДИМЕР Ø6	224
PE32-	ПАНЕЛ IR КЛЮЧ	224
PE67-	КАПАК ЗА USB ЗАХРАНВАЩ БЛОК	224
ПРИНАДЛЕЖНОСТИ АЕ		
AE10-	КАПАЧЕ	225
AE20-	СЪЕДИНИТЕЛНА КОНЗОЛА 5POLE 3P+N+E 5x4 mm ²	225
AE30-	КОНЗОЛА ЗА ВЪНШЕН МОНТАЖ 1	225
AE31-	КУТИЯ ЗА МОНТАЖ НА ПОВЪРХНОСТИ ЗА ДВОЕН КОНТАКТ	225
AE50-	СТЕННА ЗАЩИТА	226
AE51-	ЗАЩИТА ЗА ДЕЦА KS	226
РАМКИ ОЕ		
OE10-	РАМКА ЕКОНОМИК 207	227
OE20-	РАМКА ЕКОНОМИК 2 ХОРИЗОНТАЛНА	227
OE21-	РАМКА ЕКОНОМИК 2 ВЕРТИКАЛНА	227
OE30-	РАМКА ЕКОНОМИК 3 ХОРИЗОНТАЛНА	227
OE31-	РАМКА ЕКОНОМИК 3 ВЕРТИКАЛНА	228
OE40-	РАМКА ЕКОНОМИК 4 ХОРИЗОНТАЛНА	228
OE41-	РАМКА ЕКОНОМИК 4 ВЕРТИКАЛНА	228
OE50-	РАМКА ЕКОНОМИК 5 ХОРИЗОНТАЛНА	228
OE90-	ЦВЕТНИ ДЕКОРАТИВНИ РАМКИ	229
fontana		
код	описание на продукта	страница
КЛЮЧОВЕ SF		
SF10-	КЛЮЧ 1WAY IP44 10AX 250V~	232
SF10-TI	КЛЮЧ 1WAY IP44 10AX 250V~ TI	232
SF11-TI	БУТОН 1WAY IP44 10A 250V~ TI	232
SF20-	КЛЮЧ 2POLE IP44 10AX 250V~	232
SF50-	КЛЮЧ 2GANG-1WAY IP44 10AX 250V~	233
SF51-	БУТОН 2GANG-1WAY IP44 10A 250V~	233
SF60-	КЛЮЧ 2WAY IP44 10AX 250V~	233
SF60-TI	КЛЮЧ 2WAY IP44 10AX 250V~ TI	233
SF63-	ДВОЕН КЛЮЧ 2WAY 10AX 250V~	233
SF70-	КРЪСТАТ КЛЮЧ IP44 10AX 250V~	233
КОНТАКТИ VF		
VF10-	КОНТАКТ ШУКО+КАПАК IP44 2P+E 16A 250V~	234
VF12-	КОНТАКТ ШУКО+КАПАК IP44 2P+E 16A 250V~ BV	234
КОМПЛЕКТИ CF		
CF10-	КОМПЛЕКТ КОНТАКТИ ШУКО ДВОИНИ ХОРИЗОНТАЛНИ IP44 2x2P+E 16A 250V~	235
CF11-	КОМПЛЕКТ КОНТАКТИ ШУКО ДВОИНИ ВЕРТИКАЛНИ IP44 2x2P+E 16A 250V~	235
CF12-	КОМПЛЕКТ КОНТАКТИ ШУКО+КЛЮЧ 2WAY ХОРИЗОНТАЛНИ IP44 16A + 10AX 250V~	235
CF13-	КОМПЛЕКТ КОНТАКТИ ШУКО+КЛЮЧ 2WAY ВЕРТИКАЛНИ IP44 16A + 10AX 250V~	236
CF14-	КОМПЛЕКТ КОНТАКТИ ШУКО ДВОИНИ ХОРИЗОНТАЛНИ IP44 2x2P+E 16A 250V~ BV	236
CF15-	КОМПЛЕКТ КОНТАКТИ ШУКО ДВОИНИ ВЕРТИКАЛНИ IP44 2x2P+E 16A 250V~ BV	236
CF16-	КОМПЛЕКТ КОНТАКТИ ШУКО+КЛЮЧ 2WAY ХОРИЗОНТАЛНИ IP44 16A + 10AX 250V~ BV	236
CF17-	КОМПЛЕКТ КОНТАКТИ ШУКО+КЛЮЧ 2WAY ВЕРТИКАЛНИ IP44 16A + 10AX 250V~ BV	236
ПРИНАДЛЕЖНОСТИ АФ		
AF10-	РАЗПРЕДЕЛИТЕЛНА КУТИЯ IP44 RN01	237
AF20-	РАЗПРЕДЕЛИТЕЛНА КУТИЯ IP55 ND01	237



TEM

On/Off and everything in between

100% ELEKTRIČEN

www.tem.si



TEM

On/Off and everything in between



[www](http://www.tem.si)



TEM

TEM ČATEŽ d.o.o.
Čatež 13, 8212 VELIKA LOKA
SLOVENIJA
tem@tem.si
www.tem.si

T +386(0)7 348 99 00

TEM

BG

www.tem.si

