



EDGE

Powered by **MODUL**

TEM



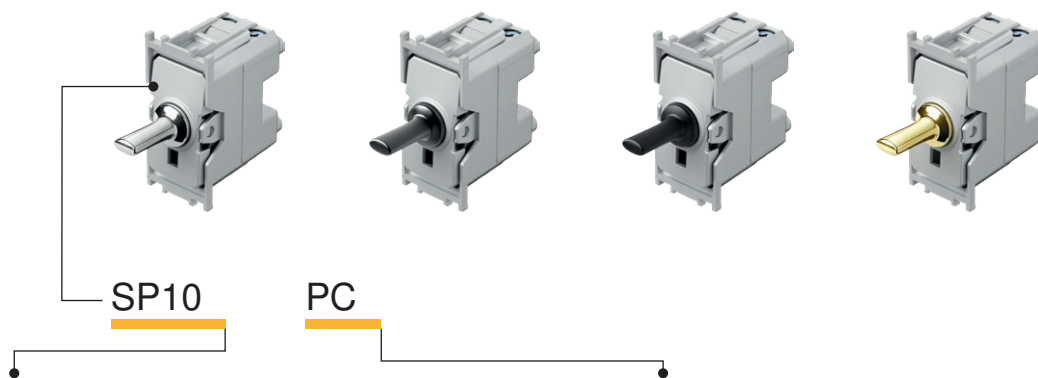

тип type	назив description	технички податоци technical data	големина size	боја на иглички pin colour
SP10	ЕДНОПОЛЕН ПРЕКИНУВАЧ SWITCH 1WAY	16AX 250V~	1M	PC хром chrome
SP11	ЕДНОПОЛНО КОПЧЕ-ПРЕКИНУВАЧ PUSH BUTTON 1WAY	16A 250V~	1M	PA антрацит anthracite
SP12	ЕДНОПОЛЕН ПРЕКИНУВАЧ SWITCH 1WAY	20A 250V~	1M	PB црна black
·	·	·	·	PG златна gold
·	·	·	·	

ЕДНОПОЛЕН ПРЕКИНУВАЧ 16AX250V~ 1M



- SP10PC
- SP10PA
- SP10PB
- SP10PG

- прекинувач
- 16AX 250V~, тип SP10
- во согласност со EN 60669-1
- завртка за прицврстување спроводници 1,5-2,5 mm²

SWITCH 1WAY 16AX 250V~ 1M

- switch
- 16AX 250V~, type SP10
- in accordance with EN 60669-1
- screw contacts 1.5-2.5mm²

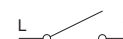
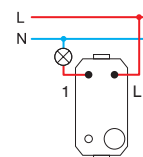

ЕДНОПОЛНО КОПЧЕ-ПРЕКИНУВАЧ 16A250V~ 1M



- SP11PC
- SP11PA
- SP11PB
- SP11PG

- прекинувач со копче
- 16A 250V~, тип SP11
- во согласност со EN 60669-1
- завртка за прицврстување спроводници 1,5-2,5 mm²

PUSH BUTTON 1WAY 16A 250V~ 1M

- push button
- 16A 250V~, type SP11
- in accordance with EN 60669-1
- screw contacts 1.5-2.5mm²

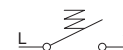
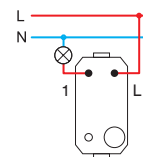

ЕДНОПОЛЕН ПРЕКИНУВАЧ 20AX250V~ 1M



- SP12PC
- SP12PA
- SP12PB
- SP12PG

- прекинувач
- 20A 250V~, тип SP12
- во согласност со EN 60669-1
- завртка за прицврстување спроводници 1,5-2,5 mm²

SWITCH 1WAY 20A 250V~ 1M

- switch
- 20A 250V~, type SP12
- in accordance with EN 60669-1
- screw contacts 1.5-2.5mm²

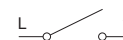
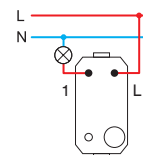

ДВОПОЛЕН ПРЕКИНУВАЧ 16AX250V~ 1M



- SP20PC
- SP20PA
- SP20PB
- SP20PG

- прекинувач
- 16AX 250V~, тип SP20
- во согласност со EN 60669-1
- завртка за прицврстување спроводници 1,5-2,5 mm²
- во комбинација со копче TM15

SWITCH 2POLE 16AX 250V~ 1M

- switch
- 16AX 250V~, type SP20
- in accordance with EN 60669-1
- screw contacts 1.5-2.5mm²
- only in combination with button TM15

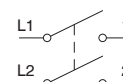
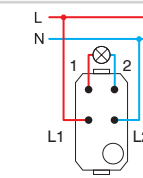



- SP40PC
- SP40PA
- SP40PB
- SP40PG

ПРЕКИНУВАЧ ЗА РОЛЕТНИ 1-0-2 16AX250V~ 1M

- прекинувач
 - 16AX 250V~, тип SP40
 - во согласност со EN 60669-1
 - завртка за прицврстување спроводници 1,5-2,5 mm²
- SWITCH SHUTTERS 1-0-2 16AX 250V~ 1M**
- switch
 - 16AX 250V~, type SP40
 - in accordance with EN 60669-1
 - screw contacts 1.5-2.5mm²

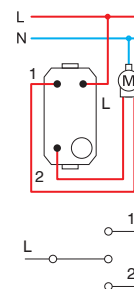

- SP41PC
- SP41PA
- SP41PB
- SP41PG

КОПЧЕ-ПРЕКИНУВАЧ ЗА РОЛЕТНИ 1-0-2 16A250V~ 1M

- прекинувач со копче
 - 16A 250V~, тип SP41
 - во согласност со EN 60669-1
 - завртка за прицврстување спроводници 1,5-2,5 mm²
- PUSH BUTTON SHUTTERS 1-0-2 16A 250V~ 1M**
- push button
 - 16A 250V~, type SP41
 - in accordance with EN 60669-1
 - screw contacts 1.5-2.5mm²

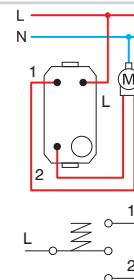

- SP60PC
- SP60PA
- SP60PB
- SP60PG

НАИЗМЕНИЧЕН ПРЕКИНУВАЧ 16AX 250V~ 1M

- прекинувач
 - 16AX 250V~, тип SP60
 - во согласност со EN 60669-1
 - завртка за прицврстување спроводници 1,5-2,5 mm²
- SWITCH 2WAY 16AX 250V~ 1M**
- switch
 - 16AX 250V~, type SP60
 - in accordance with EN 60669-1
 - screw contacts 1.5-2.5mm²

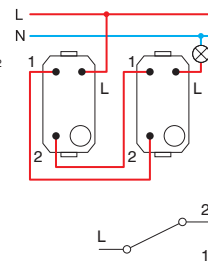

- SP61PC
- SP61PA
- SP61PB
- SP61PG

НАИЗМЕНИЧНО КОПЧЕ-ПРЕКИНУВАЧ 16A250V~ 1M

- прекинувач со копче
 - 16A 250V~, тип SP61
 - во согласност со EN 60669-1
 - завртка за прицврстување спроводници 1,5-2,5 mm²
- PUSH BUTTON 2WAY 16A 250V~ 1M**
- push button
 - 16A 250V~, type SP61
 - in accordance with EN 60669-1
 - screw contacts 1.5-2.5mm²

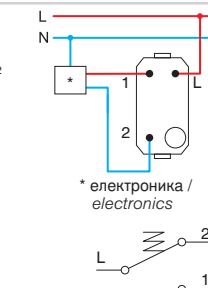

- SP70PC
- SP70PA
- SP70PB
- SP70PG

ВКРСТЕН ПРЕКИНУВАЧ 16AX250V~ 1M

- прекинувач
 - 16AX 250V~, тип SP70
 - во согласност со EN 60669-1
 - завртка за прицврстување спроводници 1,5-2,5 mm²
- SWITCH INTERMEDIATE 16AX 250V~ 1M**
- switch
 - 16AX 250V~, type SP70
 - in accordance with EN 60669-1
 - screw contacts 1.5-2.5mm²

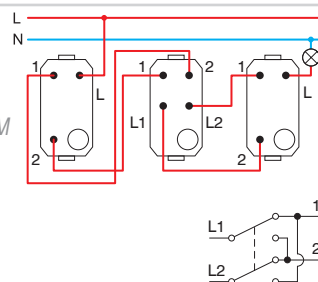

1M= 22,5 x 45

- SP10
- SP11
- SP12
- SP40
- SP41
- SP60
- SP61

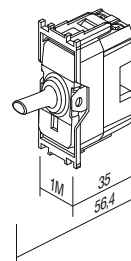

- SP20
- SP70

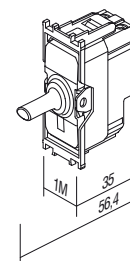

МЕТАЛ
metal

MA сребрена
silver



MT антрацит
anthracite

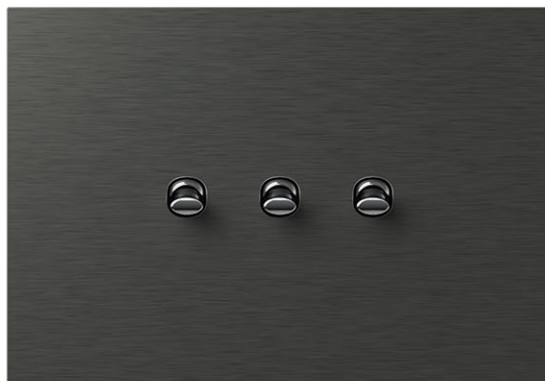

MZ златна
gold

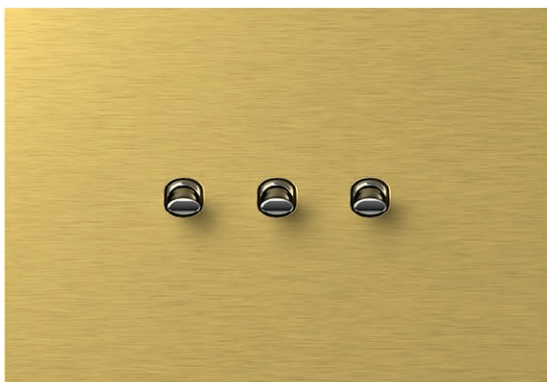

СТАКЛО
glass

GD црна
glass dark



GL бела
glass light

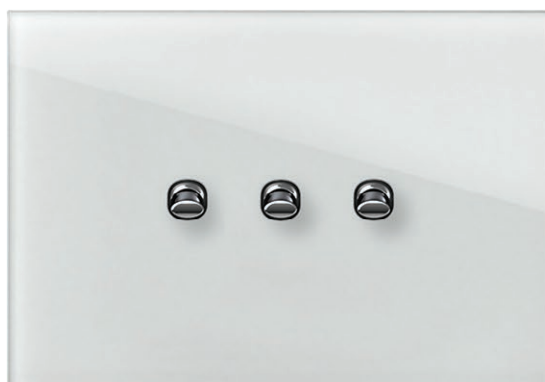

C O V E R P L A T E S E D G E O G

тип type	назив description	големина size	боја colour
OG10	ПАМКА EDGE COVER PLATE EDGE	1/2M	MA сребрена silver
OG13	ПАМКА EDGE COVER PLATE EDGE	1/3M	MT антрацит anthracite
OG20	ПАМКА EDGE COVER PLATE EDGE	2M	MZ златна gold
...

боја colour	код	назив
	GD	црна glass dark
	GL	бела glass light

тип	назив
P	
M	

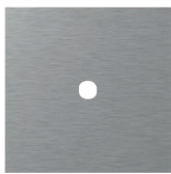

- OG10MAP
- OG10MTP
- OG10MZP
- OG10GDP
- OG10GLP

ПАМКА EDGE 1/2M

- декоративна рамка EDGE 1/2M
- во согласност со EN 60669-1

COVER PLATE EDGE 1/2M

- decorative cover plate EDGE 1/2M
- in accordance with EN 60669-1

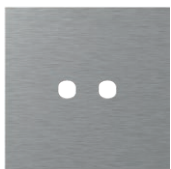

- OG20MAP
- OG20MTP
- OG20MZP
- OG20GDP
- OG20GLP

ПАМКА EDGE 2M

- декоративна рамка EDGE 2M
- во согласност со EN 60669-1

COVER PLATE EDGE 2M

- decorative cover plate EDGE 2M
- in accordance with EN 60669-1

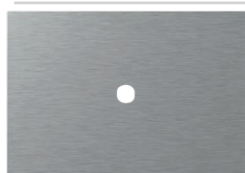

 OG13MAP	 OG13GDP
 OG13MTP	 OG13GLP
 OG13MZP	

PAMKA LINE 1/3M

- декоративна рамка EDGE 1/3M
- во согласност со EN 60669-1

COVER PLATE EDGE 1/3M

- decorative cover plate EDGE 1/3M
- in accordance with EN 60669-1

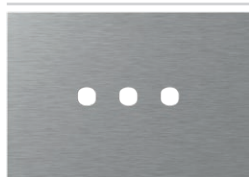

 OG30MAP	 OG30GDP
 OG30MTP	 OG30GLP
 OG30MZP	

PAMKA EDGE 3M

- декоративна рамка EDGE 3M
- во согласност со EN 60669-1

COVER PLATE EDGE 3M

- decorative cover plate EDGE 3M
- in accordance with EN 60669-1



 OG40MAP	 OG40GDP
 OG40MTP	 OG40GLP
 OG40MZP	

PAMKA EDGE 4M

- декоративна рамка EDGE 4M
- во согласност со EN 60669-1

COVER PLATE EDGE 4M

- decorative cover plate EDGE 4M
- in accordance with EN 60669-1

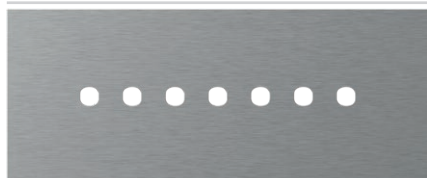

 OG70MAP	 OG70GDP
 OG70MTP	 OG70GLP
 OG70MZP	

PAMKA EDGE 7M

- декоративна рамка EDGE 7M
- во согласност со EN 60669-1

COVER PLATE EDGE 7M

- decorative cover plate EDGE 7M
- in accordance with EN 60669-1

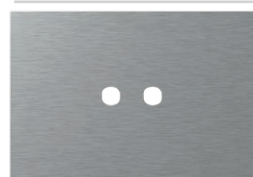

 OG23MAP	 OG23GDP
 OG23MTP	 OG23GLP
 OG23MZP	

PAMKA LINE 2/3M

- декоративна рамка EDGE 2/3M
- во согласност со EN 60669-1

COVER PLATE EDGE 2/3M

- decorative cover plate EDGE 2/3M
- in accordance with EN 60669-1

МЕТАЛ
metal

MA сребрена
silver

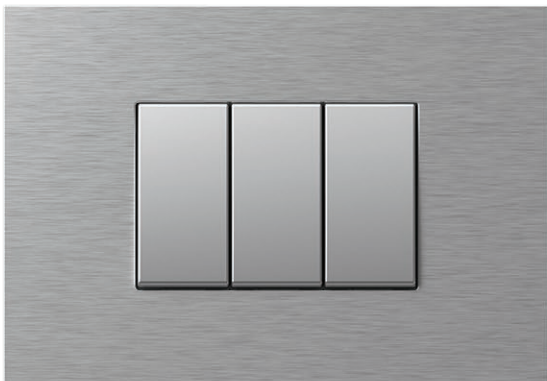

MT антрацит
anthracite

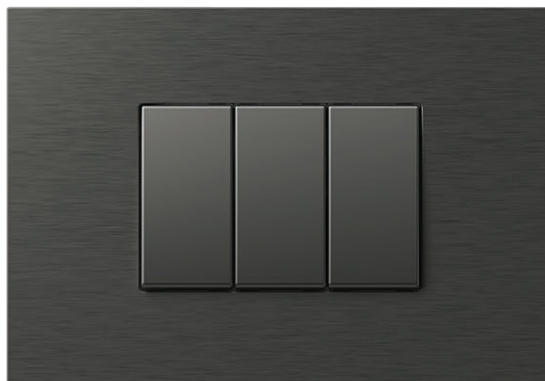

MZ златна
gold

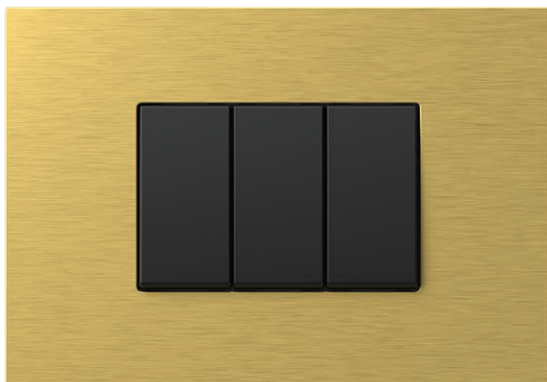

СТАКЛО
glass

GD црна
glass dark

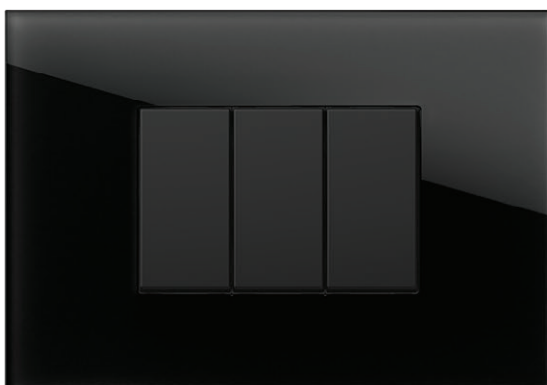

GL бела
glas light

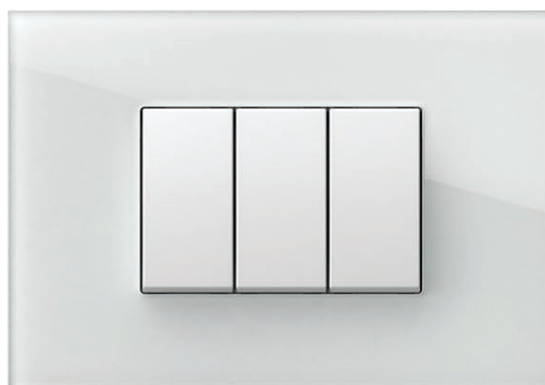

COVER PLATES EDGE OG

тип type	назив description	големина size	боја colour
OG10	ПАМКА EDGE COVER PLATE EDGE	1/2M	MA сребрена silver
OG13	ПАМКА EDGE COVER PLATE EDGE	1/3M	MT антрацит anthracite
OG20	ПАМКА EDGE COVER PLATE EDGE	2M	MZ златна gold
...

GD црна
glass dark

GL бела
glass light

M

P

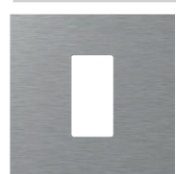

OG10MAM	OG10GDM
OG10MTM	OG10GLM
OG10MZM	

ПАМКА EDGE 1/2M

- декоративна рамка EDGE 1/2M
- во согласност со EN 60669-1

COVER PLATE EDGE 1/2M

- decorative cover plate EDGE 1/2M
- in accordance with EN 60669-1

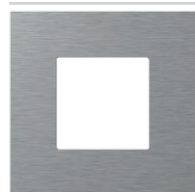

OG20MAM	OG20GDM
OG20MTM	OG20GLM
OG20MZM	

ПАМКА EDGE 2M

- декоративна рамка EDGE 2M
- во согласност со EN 60669-1

COVER PLATE EDGE 2M

- decorative cover plate EDGE 2M
- in accordance with EN 60669-1

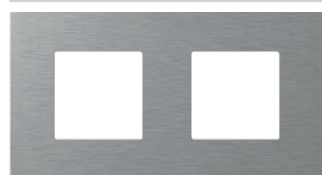

OG24MAM	OG24GDM
OG24MTM	OG24GLM
OG24MZM	

ПАМКА LINE 2x2M

- декоративна рамка EDGE 2x2M
- хоризонтална или вертикална монтажа
- во согласност со EN 60669-1

COVER PLATE EDGE 2x2M

- decorative cover plate EDGE 2x2M
- horizontal or vertical mounting
- in accordance with EN 60669-1

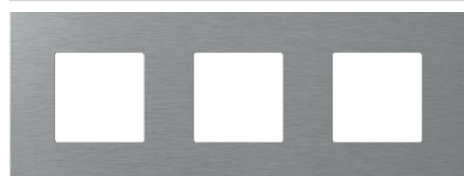

OG26MAM	OG26GDM
OG26MTM	OG26GLM
OG26MZM	

ПАМКА LINE 3x2M

- декоративна рамка EDGE 3x2M
- хоризонтална или вертикална монтажа
- во согласност со EN 60669-1

COVER PLATE EDGE 3x2M

- decorative cover plate EDGE 3x2M
- horizontal or vertical mounting
- in accordance with EN 60669-1

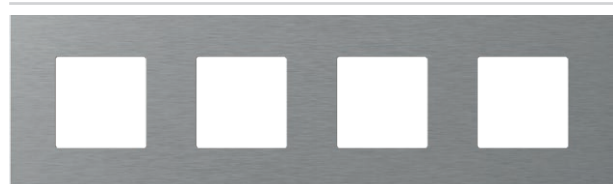

OG28MAM	OG28GDM
OG28MTM	OG28GLM
OG28MZM	

ПАМКА LINE 4x2M

- декоративна рамка EDGE 4x2M
- хоризонтална или вертикална монтажа
- во согласност со EN 60669-1

COVER PLATE EDGE 4x2M

- decorative cover plate EDGE 4x2M
- horizontal or vertical mounting
- in accordance with EN 60669-1

MODUL

EDGE

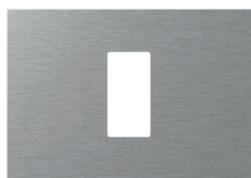

OG13MAM
OG13MTM
OG13MZM

OG13GDM
OG13GLM

PAMKA LINE 1/3M

- декоративна рамка EDGE 1/3M
- во согласност со EN 60669-1

COVER PLATE EDGE 1/3M

- decorative cover plate EDGE 1/3M
- in accordance with EN 60669-1



OG30MAM
OG30MTM
OG30MZM

OG30GDM
OG30GLM

PAMKA EDGE 3M

- декоративна рамка EDGE 3M
- во согласност со EN 60669-1

COVER PLATE EDGE 3M

- decorative cover plate EDGE 3M
- in accordance with EN 60669-1



OG40MAM
OG40MTM
OG40MZM

OG40GDM
OG40GLM

PAMKA EDGE 4M

- декоративна рамка EDGE 4M
- во согласност со EN 60669-1

COVER PLATE EDGE 4M

- decorative cover plate EDGE 4M
- in accordance with EN 60669-1



OG70MAM
OG70MTM
OG70MZM

OG70GDM
OG70GLM

PAMKA EDGE 7M

- декоративна рамка LINE 7M
- во согласност со EN 60669-1

COVER PLATE EDGE 7M

- decorative cover plate EDGE 7M
- in accordance with EN 60669-1



OG23MAM
OG23MTM
OG23MZM

OG23GDM
OG23GLM

PAMKA LINE 2/3M

- декоративна рамка EDGE 2/3M
- во согласност со EN 60669-1

COVER PLATE EDGE 2/3M

- decorative cover plate EDGE 2/3M
- in accordance with EN 60669-1

C O V E R P L A T E S E D G E O G



MODUL

EDGE

A x B



1/2M

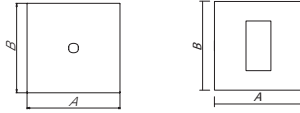

92 x 92 mm

2M

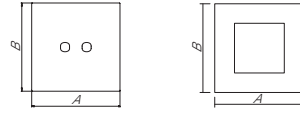

92 x 92 mm

2x2M

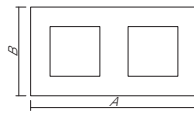

163 x 92 mm

3x2M

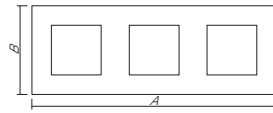

234 x 92 mm

4x2M

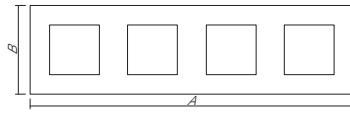

305 x 92 mm



1/3M

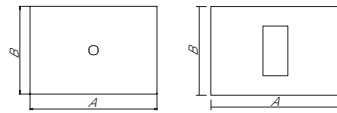

132 x 92 mm

3M

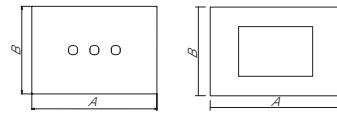

132 x 92 mm

4M

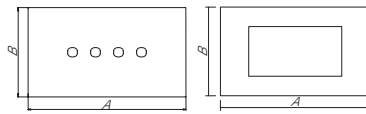

154 x 92 mm

7M

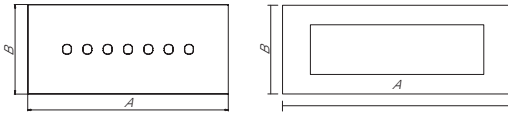

222 x 92 mm



2/3M

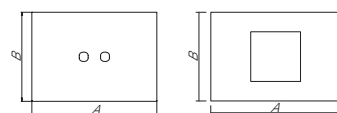

132 x 92 mm

TECHNICAL CATALOGUE
MODUL EDGE

2023

MK

