

TEM

LOGIO

SWITCH
LOGIQ



TEM

On/Off and everything in between

LOGIQ



Proizvođač smo sklopki i utičnica, koji svojim korisnicima pruža pozitivno i jednostavno iskustvo, dok istovremeno jednostavnom ugradnjom i uporabom proizvoda, širokim izborom boja i materijala zadovoljava i najzahtjevnije želje svakog korisnika i prostora.

We are a manufacturer of switches and sockets offering a positive and easy user experience while satisfying the most demanding needs of every user and space with products that are easy to install and use, as well as a wide range of colours and materials.

LOGIQ

LOGIQ

B O L D



LOGIQ

F L A T



LOGIQ

P R I M E



LOGIQ

B O L D



Naglašen dizajn pronalazi mjesto u svakoj prostoriji.

The distinctive shape has a place in every room.



LOGIQ

B O L D



PW



bijela-sjaj

polar white

TI



titan

titanium

AT



antracit

anthracite

BK

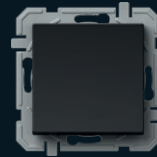

crna

black



PW **bijela-sjaj**
polar white



TI **titan**
titanium



AT **antracit**
anthracite



BK **crna**
black

LOGIQ
BOLD





LOGIQ

FLAT

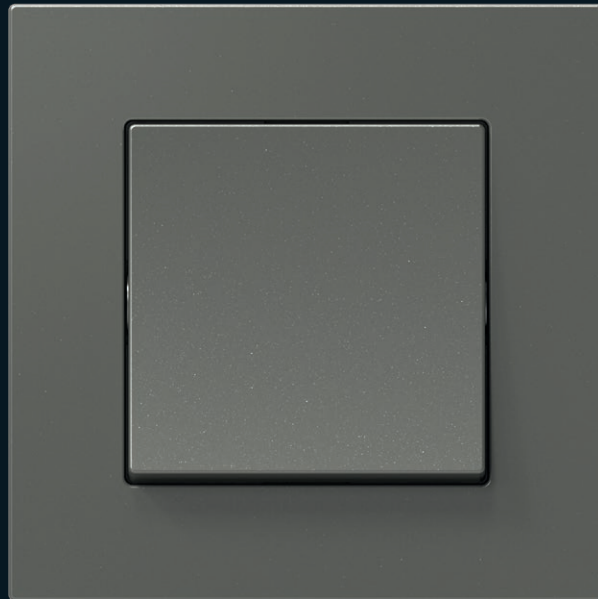

Elegantan, ravan, četvrtast.

Elegant, flat, square.

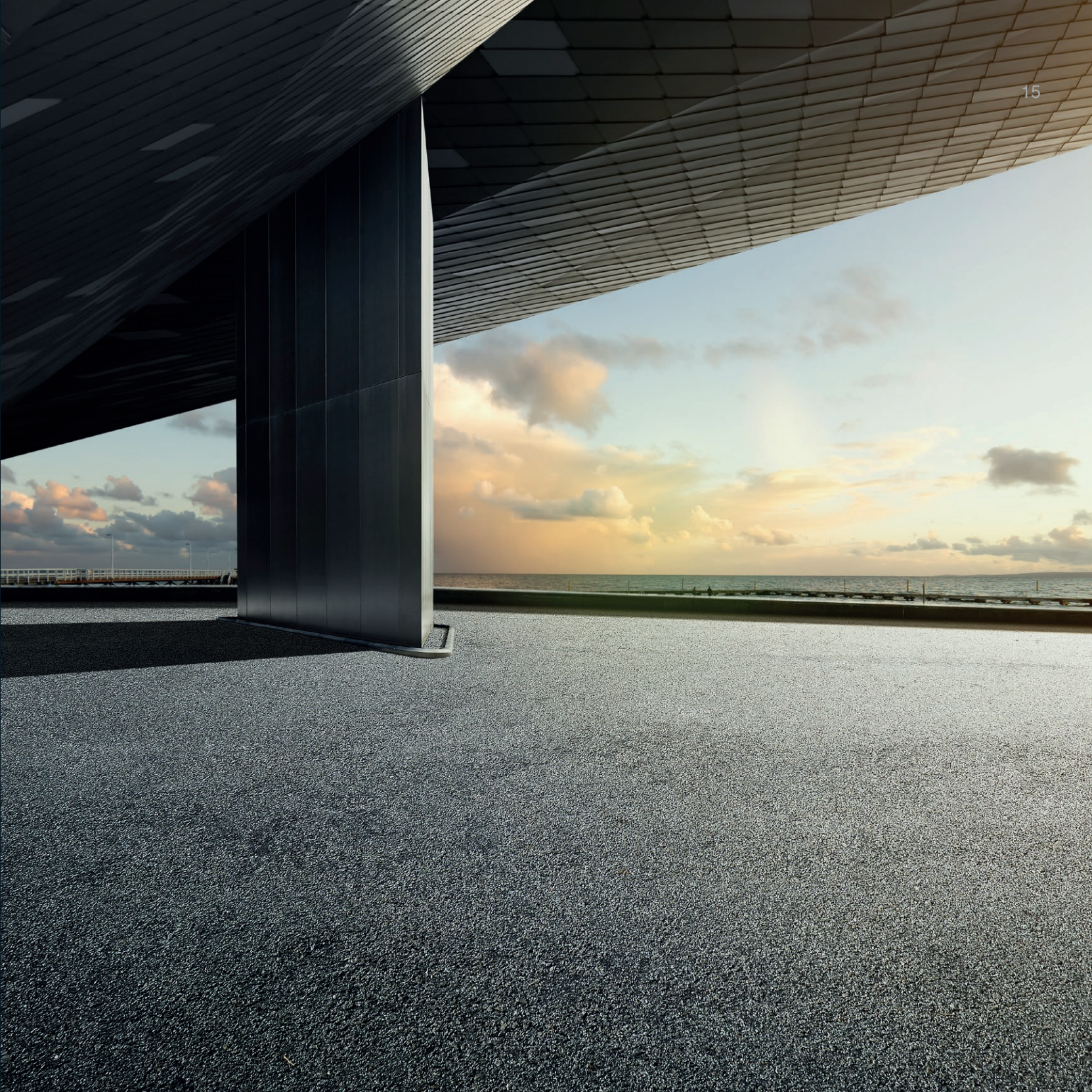

LOGIQ

FLAT



PW



bijela-sjaj

polar white

TI



titan

titanium

AT



antracit

anthracite

BK

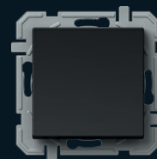

crna

black



PW **bijela-sjaj**
polar white



TI **titan**
titanium



AT **antracit**
anthracite

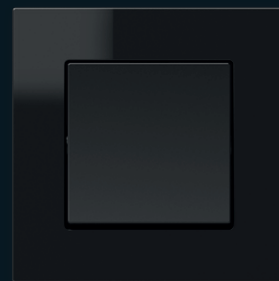

BK **crna**
black

LOGIQ
FLAT



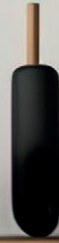

LOGIQ

PRIME



Odsjaj stakla budi osjećaj prestiža.

The reflection of the glass awakens the magnate in you.



LOGIQ

PRIME



PW



bijela-sjaj

polar white

TI



titan

titanium

AT



antracit

anthracite

BK



crna

black

staklo

glass



GL **bijela**
glass light



GD **crna**
glass dark

LOGIQ

PRIME





N a p r a v l j e n o z a b i l o k o j i p r o s t o r

Univerzalne linije sklopki ostavljaju svoj pečat u modernim radnim okružjima ili u kućnim, toplijim stambenim prostorima. Za svaku vašu želju obitelj sklopki LOGIQ nudi vam jednostavno i logično rješenje.

M a d e f o r e v e r y r o o m

The switches have universal lines that make a mark in both modern work environments and cosy, comfortable living spaces. The LOGIQ family of switches offers a simple and logical solution for your every wish.



H a r m o n i j a b o j a z a b i l o k o j i p r o s t o r

Obitelj LOGIQ odlikuje se logičnim izborom provjerenih i elegantnih nijansi boja koje korisnici najviše vole. Ne prilagođavajte se vi, LOGIQ se prilagođava vama.

H a r m o n y o f c o l o u r s f o r e v e r y r o o m

The LOGIQ family prides itself on its logical range of verified and elegant hues known and loved by our users. Do not compromise, LOGIQ has you covered.

- **crna**
black
- **antracit**
anthracite
- **titan**
titanium
- **bijela-sjaj**
polar white



Neograničena mašta

Limitless imagination

Obitelj LOGIQ omogućuje vam sastavljanje proizvoljnih kombinacija. Za jednostavno kombiniranje za vas smo izradili koristan dodatak koji će vam olakšati nizanje vodoravnih i okomitih linija. Takozvani sustav 55/55 omogućuje korištenje istih univerzalnih elemenata.

The LOGIQ family allows you to create your own combinations. To make combining simple, we have created a useful system that supports the sequencing of horizontal and vertical lines. The so-called 55/55 system allows you to use the same universal elements every time.



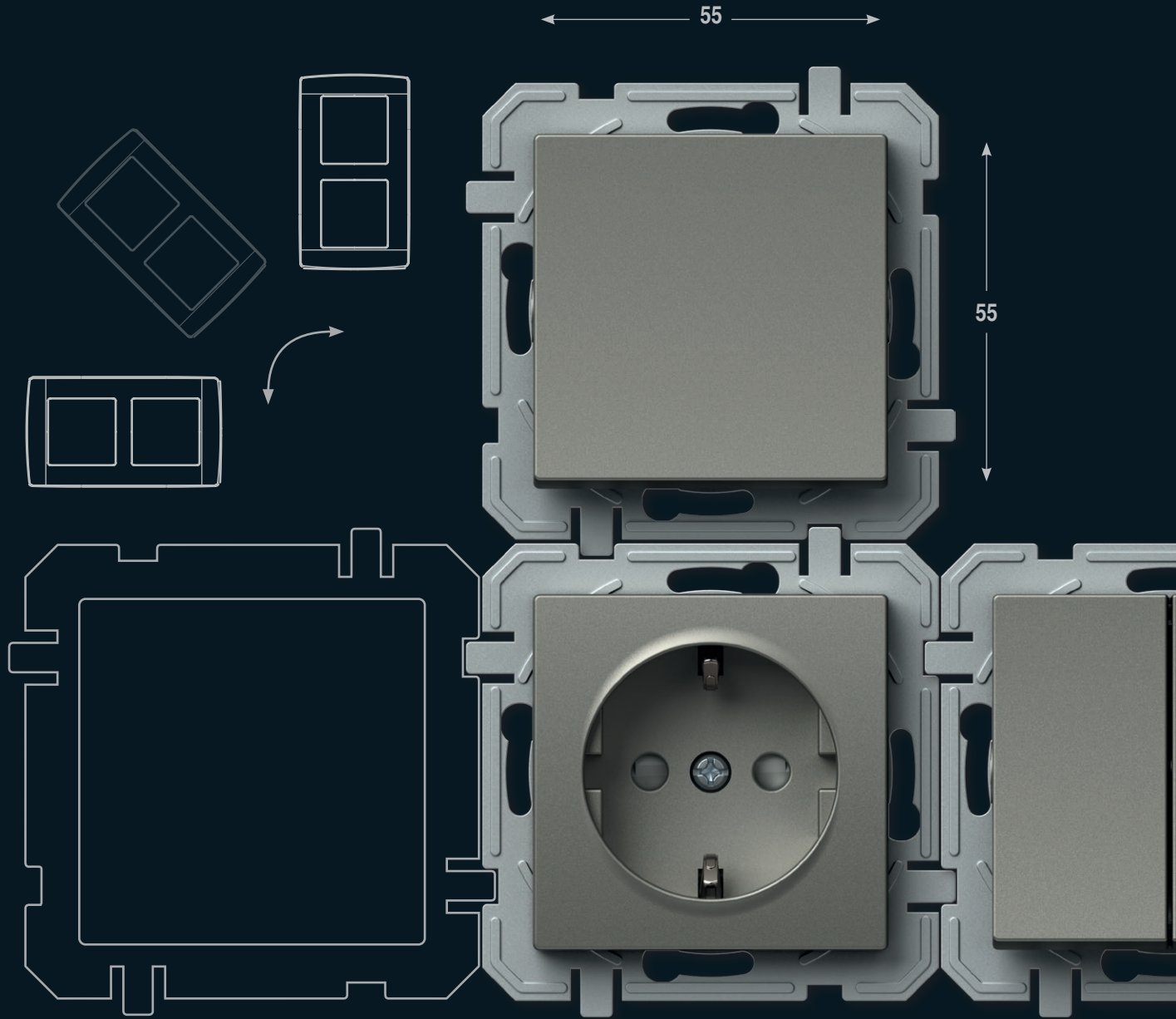

Jednostavno za najzahtjevnije

Obitelj LOGIQ nudi funkcionalne elemente za svaki prostor i namjenu. Možete ih upotrijebiti pojedinačno ili u nizu. Vodoravno ili okomito. Logično.



Univerzalno postavljanje ukrasnih okvira sve tri dizajnerske linije BOLD, FLAT i PRIME.

A universal layout of decorative cover plates in all three design lines – BOLD, FLAT and PRIME.



Simple for the most demanding

The LOGIQ family offers functional elements for every space and purpose. You can use these products individually or in a sequence, horizontally or vertically. Logically.

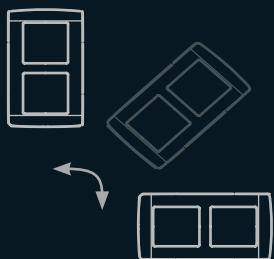

Logična ugradnja

Logical installation

LOGIQ je rješenje za sustav standardnih okruglih doza. S pomoću njega možete planirati jednostavne i zahtjevne instalacije, novogradnje i adaptacije. Sustav karakteriziraju bezvijačani kontakti koji vam štede vrijeme tijekom ugradnje elemenata.

LOGIQ is a solution for the system of standardised round installation boxes. It can be used for simple and more demanding installations, new buildings and adaptations. The system is characterised by plug-in contacts that save time during the installation of elements.

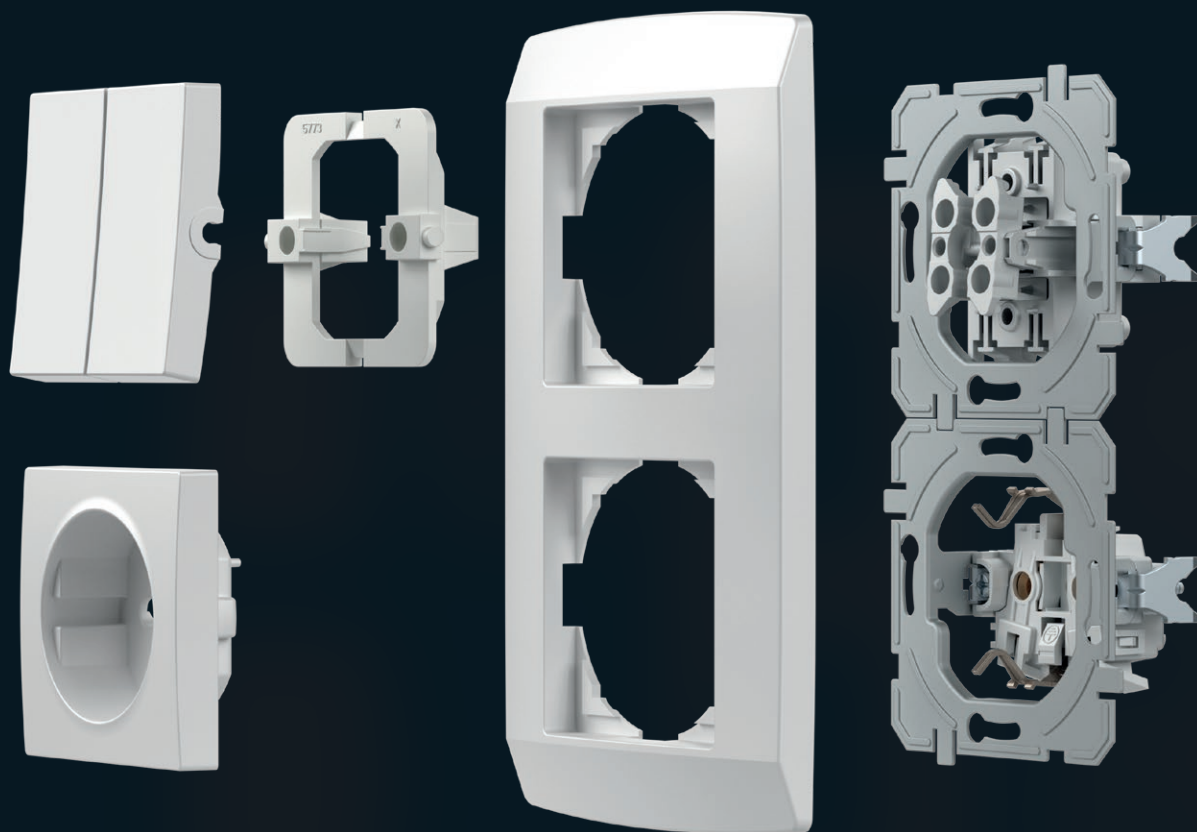

Dobro je znati

Good to know



Sve su utičnice opremljene sigurnosnim sklopovima koji osiguravaju zaštitu od kontakta s naponom.

All the sockets are equipped with a safety shutters assuring the protection to live contacts.



Dobro osmišljena konstrukcija sklopki omogućuje jednostavno dodatnu indicaciju.

The well-thought-out design of the switch enables the easy integration of the indication, including at a later time.



Pouzdanost preklopa osiguravaju kontakti izrađeni od srebrne legure.

Contacts made of silver alloy guarantee safe switching.



Bezvijčani kontakti omogućuju brzo i pouzdano spajanje vodiča. Na isti kontakt možete pričvrstiti dva vodiča različitih promjera.

Plug-in contacts enable quick and reliable attachment of wires. Two wires of different diameters can be attached to the same contact.



Nožice omogućuju dublje pričvršćivanje (također preko keramičkih pločica itd.)

Fixing claws enable deeper fixing (also through ceramic tiles, etc.)



Sastavljive doze olakšat će vam rad. Prave udaljenosti su vam zajamčene.

Easy-fitting installation boxes will make your work easier. Proper lengths are guaranteed.

SQ11 **PW** **IN** **01** **XO**

tip type	naziv description	tehnički opis technical data	boja colour	opcijnski opis 1 optional data 1	opcijnski opis 2 optional data 2	opcijnski opis 3 optional data 3
SQ10	SKLOPKA JEDNOPOLNA SWITCH 1WAY	10AX 250V~	□ PW bijela – sjaj polar white	NT neutralna neutral	01	XO bez okvira without cover plate
SQ11	TIPKALO JEDNOPOLNO PUSH BUTTON 1WAY	10A 250V~	■ TI titan titanium	IN indikator indicator	02	
SQ22	SKLOPKA DVOPOLNA SWITCH 2POLE	16AX 250V~	■ AT antracit anthracite		03	
:	:	:	■ BK crna black			

SKLOPKA JEDNOPOLNA 10AX 250V~



- SQ10PWXO
- SQ10TIXO
- SQ10ATXO
- SQ10BKXO



- 10AX 250V~, tip SQ10
 - usklađeno s normom EN 60669-1
 - bezvijčano pričvršćivanje vodiča 1.5-2.5mm²
- SWITCH 1WAY 10AX 250V~*
- 10AX 250V~, type SQ10
 - in accordance with EN 60669-1
 - plug-in contacts 1.5-2.5mm²



SKLOPKA JEDNOPOLNA 10AX 250V~ __ IN



- SQ10PWINXO
- SQ10TIINXO
- SQ10ATINXO
- SQ10BKINXO

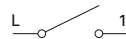

- IN indikator, bez neonske tinjalice
 - 10AX 250V~, tip SQ10
 - usklađeno s normom EN 60669-1
 - bezvijčano pričvršćivanje vodiča 1.5-2.5mm²
- SWITCH 1WAY 10AX 250V~ __ IN*
- IN indicator, without neon lamp
 - 10AX 250V~, type SQ10
 - in accordance with EN 60669-1
 - plug-in contacts 1.5-2.5mm²





- SQ11PWXO
- SQ11TIXO
- SQ11ATXO
- SQ11BKXO

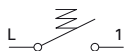

TIPKALO JEDNOPOLNO 10A 250V~

- 10A 250V~, tip SQ11
- usklađeno s normom EN 60669-1
- bezvijačno pričvršćivanje vodiča 1.5-2.5mm²

PUSH BUTTON 1WAY 10A 250V~

- 10A 250V~, type SQ11
- in accordance with EN 60669-1
- plug-in contacts 1.5-2.5mm²



- SQ11PWIN01XO
- SQ11TIIN01XO
- SQ11ATIN01XO
- SQ11BKIN01XO

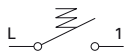

TIPKALO JEDNOPOLNO 10A 250V~ __ IN 01

- IN 01 indikator zvona, bez neonske tinjalice
- 10A 250V~, tip SQ11
- usklađeno s normom EN 60669-1
- bezvijačno pričvršćivanje vodiča 1.5-2.5mm²

PUSH BUTTON 1WAY 10A 250V~ __ IN 01

- IN 01 indicator bell, without neon lamp
- 10A 250V~, type SQ11
- in accordance with EN 60669-1
- plug-in contacts 1.5-2.5mm²



- SQ11PWIN02XO
- SQ11TIIN02XO
- SQ11ATIN02XO
- SQ11BKIN02XO

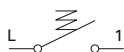

TIPKALO JEDNOPOLNO 10A 250V~ __ IN 02

- IN 02 indikator svjetla, bez neonske tinjalice
- 10A 250V~, tip SQ11
- usklađeno s normom EN 60669-1
- vijčano pričvršćivanje vodiča 1.5-2.5mm²

PUSH BUTTON 1WAY 10A 250V~ __ IN 02

- IN 02 indicator light, without neon lamp
- 10A 250V~, type SQ11
- in accordance with EN 60669-1
- plug-in contacts 1.5-2.5mm²



- SQ22PWIN03XO
- SQ22TIIN03XO
- SQ22ATIN03XO
- SQ22BKIN03XO

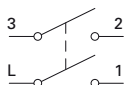

SKLOPKA DVOPOLNA 16AX 250V~ __ IN 03

- IN 03 neutralna 0-1, bez neonske tinjalice
- 16AX 250V~, tip SQ22
- usklađeno s normom EN 60669-1
- vijčano pričvršćivanje vodiča 1.5-2.5mm²

SWITCH 2POLE 16AX 250V~ __ IN 03

- IN 03 neutral 0-1, without neon lamp
- 16AX 250V~, type SQ22
- in accordance with EN 60669-1
- screw contacts 1.5-2.5mm²



- SQ50PWXO
- SQ50TIXO
- SQ50ATXO
- SQ50BKXO

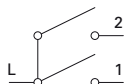

SKLOPKA SERIJSKA 10AX 250V~

- 10AX 250V~, tip SQ50
- usklađeno s normom EN 60669-1
- bezvijačno pričvršćivanje vodiča 1.5-2.5mm²

SWITCH 2GANG-1WAY 10AX 250V~

- 10AX 250V~, type SQ50
- in accordance with EN 60669-1
- plug-in contacts 1.5-2.5mm²

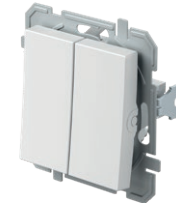

TIPKALO SERIJSKO 10A 250V~



- SQ51PWXO
- SQ51TIXO
- SQ51ATXO
- SQ51BKXO

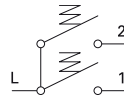

- 10A 250V~, tip SQ51
- usklađeno s normom EN 60669-1
- bezvijčano pričvršćivanje vodiča 1.5-2.5mm²

PUSH BUTTON 2GANG-1WAY 10A 250V~

- 10A 250V~, type SQ51
- in accordance with EN 60669-1
- plug-in contacts 1.5-2.5mm²



SKLOPKA ŽALUZIJSKA 10AX 250V~ __ NT 09



- SQ52PWNT09XO
- SQ52TINT09XO
- SQ52ATNT09XO
- SQ52BKNT09XO

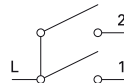

- NT 09 neutralna gore-dolje
- 10AX 250V~, tip SQ52
- usklađeno s normom EN 60669-1
- bezvijčano pričvršćivanje vodiča 1.5-2.5mm²
- s mehaničkim blokiranjem istodobnog uključivanja

SWITCH SHUTTERS 10AX 250V~ __ NT 09

- NT 09 neutral up-down
- 10AX 250V~, type SQ52
- in accordance with EN 60669-1
- plug-in contacts 1.5-2.5mm²
- with mechanical interblock



TIPKALO ŽALUZIJSKO 10A 250V~ __ NT 09



- SQ53PWNT09XO
- SQ53TINT09XO
- SQ53ATNT09XO
- SQ53BKNT09XO

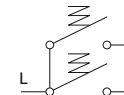

- NT 09 neutralna gore-dolje
- 10A 250V~, tip SQ53
- usklađeno s normom EN 60669-1
- bezvijčano pričvršćivanje vodiča 1.5-2.5mm²
- s mehaničkim blokiranjem istodobnog uključivanja

PUSH BUTTON SHUTTERS 10A 250V~ __ NT 09

- NT 09 neutral up-down
- 10A 250V~, type SQ53
- in accordance with EN 60669-1
- plug-in contacts 1.5-2.5mm²
- with mechanical interblock



SKLOPKA IZMJENIČNA 10AX 250V~

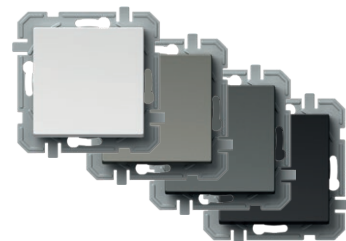

- SQ60PWXO
- SQ60TIXO
- SQ60ATXO
- SQ60BKXO

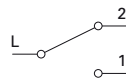

- 10AX 250V~, tip SQ60
- usklađeno s normom EN 60669-1
- bezvijčano pričvršćivanje vodiča 1.5-2.5mm²

SWITCH 2WAY 10AX 250V~

- 10AX 250V~, type SQ60
- in accordance with EN 60669-1
- plug-in contacts 1.5-2.5mm²



SKLOPKA IZMJENIČNA DVOSTRUKA 10AX 250V~



- SQ63PWXO
- SQ63TIXO
- SQ63ATXO
- SQ63BKXO



- 10AX 250V~, tip SQ63
- usklađeno s normom EN 60669-1
- bezvijčano pričvršćivanje vodiča 1.5-2.5mm²

SWITCH DOUBLE 2WAY 10AX 250V~

- 10AX 250V~, type SQ63
- in accordance with EN 60669-1
- plug-in contacts 1.5-2.5mm²





- SQ70PWXO
- SQ70TIXO
- SQ70ATXO
- SQ70BKXO



SKLOPKA KRIŽNA 10AX 250V~

- 10AX 250V~, tip SQ70
- usklađeno s normom EN 60669-1
- bezvijčano pričvršćivanje vodiča 1.5-2.5mm²

SWITCH INTERMEDIATE 10AX 250V~

- 10AX 250V~, type SQ70
- in accordance with EN 60669-1
- plug-in contacts 1.5-2.5mm²



SQ10
SQ11

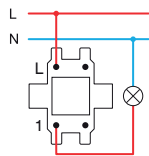

SQ22

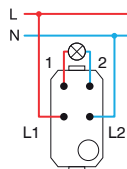

SQ50
SQ51

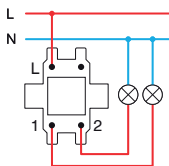

SQ52
SQ53

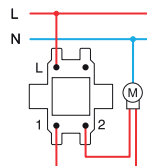

SQ60+SQ60

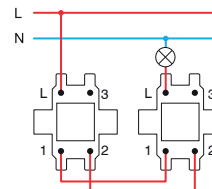

SQ63+SQ63

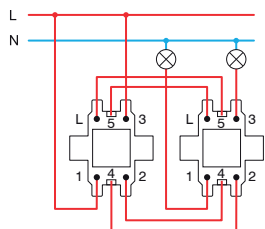

SQ60+SQ70+SQ60

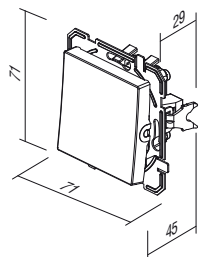
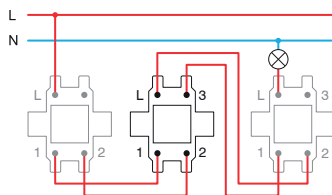

S I G N A L I Z A C I J A I A

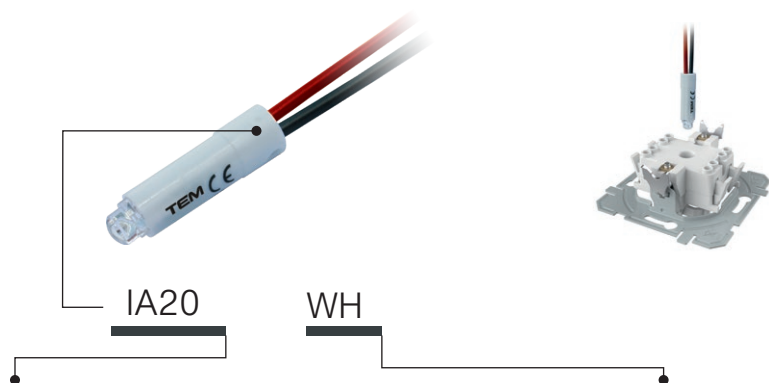

tip type	naziv description	tehnički opis technical data	boja colour
IA10	NEONSKA TINJALICA NEON LAMP	230V~ 0,34W	<input type="checkbox"/> WH bijela white
IA20	LED SIGNALIZACIJA LED SIGNALLING UNIT	230V~ 0,40W	<input checked="" type="checkbox"/> BL plava blue
IA21	LED SIGNALIZACIJA LED SIGNALLING UNIT	24V AC/DC 0,20W	<input checked="" type="checkbox"/> RD crvena red
.	.	.	<input checked="" type="checkbox"/> GR zelena green
.	.	.	<input checked="" type="checkbox"/> OR narančasta orange

NEONSKA TINJALICA 230V~ 0,34W



IA10OR

- za indicaciju, osvjetljenje ili stalno osvjetljenje sklopke
- u kombinaciji s tipkom s indikatorom

NEON LAMP 230V~ 0,34W

- for indication, illumination or constant illumination of switch
- in combination with button with indicator

LED SIGNALIZACIJA 230V AC/DC 0,40W

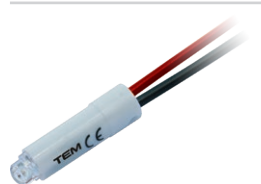

IA20WH
 IA20GR
 IA20RD
 IA20BL

- za indicaciju, signalizaciju ili stalnu signalizaciju
- u kombinaciji s tipkom s indikatorom

LED SIGNALLING UNIT 230V AC/DC 0,40W

- for indication, signalling or permanent signalling
- in combination with a button featuring an indicator

LED SIGNALIZACIJA 24V AC/DC 0,20W



IA21WH
 IA21RD

- za indicaciju, signalizaciju ili stalnu signalizaciju
- u kombinaciji s tipkom s indikatorom

LED SIGNALLING UNIT 24V AC/DC 0,20W

- for indication, signalling or permanent signalling
- in combination with a button featuring an indicator

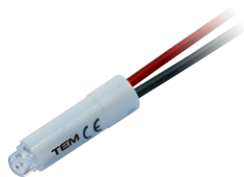

- IA22WH
- IA22RD

LED SIGNALIZACIJA 12V AC/DC 0,10W

- za indicaciju, signalizaciju ili stalnu signalizaciju
- u kombinaciji s tipkom s indikatorom

LED SIGNALLING UNIT 12V AC/DC 0,10W

- for indication, signalling or permanent signalling
- in combination with a button featuring an indicator

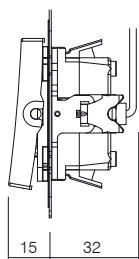

S I G N A L I Z A C I J A I A

* Indikacija /
Indication

Signalizacija /
Signalization

* Stalna signalizacija
Permanent signalling

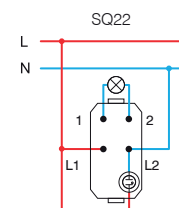
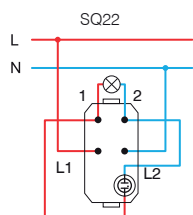
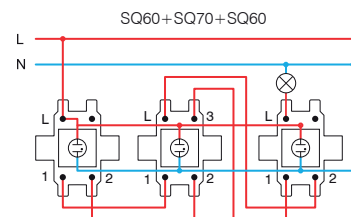
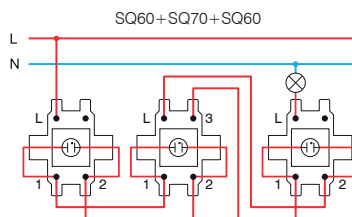
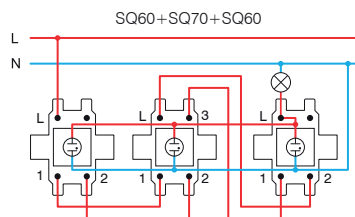
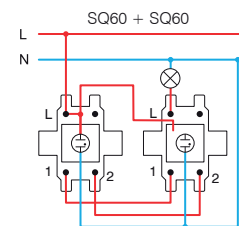
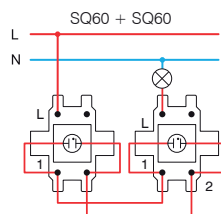
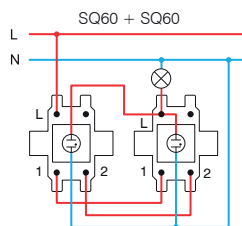
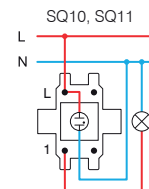
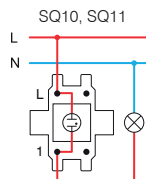
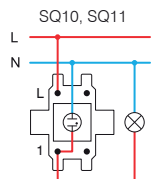

* spajanje prikladno za štedljive (CFL, LED) tinjalice /
wiring scheme for energy saving lamps (CFL, LED)

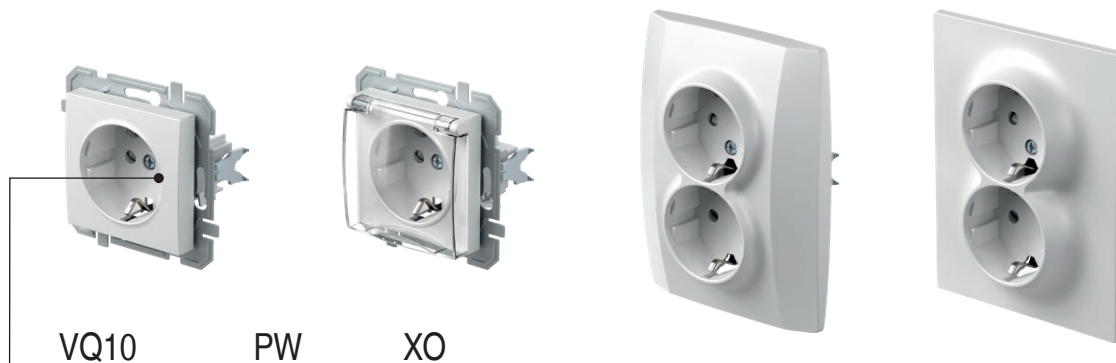

tip type	naziv description	tehnički opis technical data	opcijski podatci 1 optional data 1
VQ10	UTIČNICA ŠUKO SOCKET SCHUKO	2P+E 16A 250V~	XO bez okvira without cover plate
VQ11	UTIČNICA ŠUKO+POKLOPAC SOCKET SCHUKO+COVER	2P+E 16A 250V~	
VQ12	UTIČNICA ŠUKO SOCKET SCHUKO	2P+E 16A 250V~ BV	
:	:	:	
:	:	:	

boja
colour

<input type="checkbox"/> PW	bijela – sjaj polar white	<input type="checkbox"/> PT	bijela+prozirna white+transparent	<input type="checkbox"/> PP	bijela+bijela white+white
<input type="checkbox"/> TI	titan titanium	<input type="checkbox"/> TT	titan+prozirna titanium+transparent	<input type="checkbox"/> TI	titan+titan titanium+titanium
<input type="checkbox"/> AT	antracit anthracite	<input type="checkbox"/> AT	antracit+prozirna anthracite+transparent	<input type="checkbox"/> AA	antracit+antracit anthracite+anthracite
<input type="checkbox"/> BK	crna black	<input type="checkbox"/> BT	crna+prozirna black+transparent	<input type="checkbox"/> BB	crna+ crna black+black
<input type="checkbox"/> RD	crvena red	<input type="checkbox"/> RT	crvena+prozirna red+transparent	<input type="checkbox"/> RR	crvena+crvena red+red
<input type="checkbox"/> GR	zelena green	<input type="checkbox"/> GT	zelena+prozirna green+transparent	<input type="checkbox"/> GG	zelena+zelena green+green
<input type="checkbox"/> OR	narančasta orange	<input type="checkbox"/> OT	narančasta+prozirna orange+transparent	<input type="checkbox"/> OO	narančasta+narančasta orange+orange



šuko – usklađen s normom EN 60884-1, CEE7 (lista standarda III)

schuko - in accordance with EN 60884-1, CEE7 (standard sheet III)

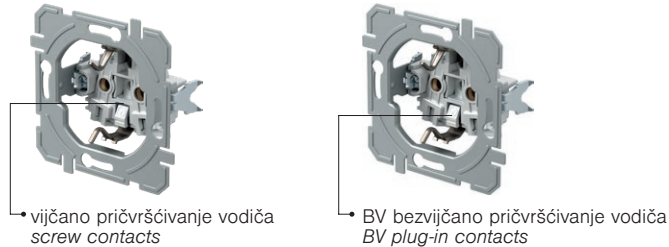

UTIČNICA ŠUKO 2P+E 16A 250V~ __ XO

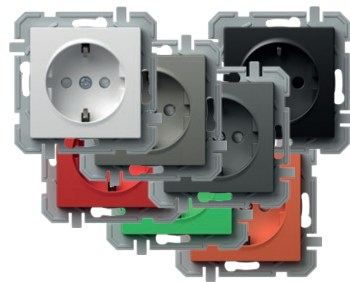

- VQ10PWXO
- VQ10TIXO
- VQ10ATXO
- VQ10BKXO

- VQ10RDXO
- VQ10GRXO
- VQ10ORXO

- vijčano pričvršćivanje vodiča 1.5-2.5mm²
- XO bez okvira
- 2P+E šuko
- 16A 250V~, tip VQ10
- zaštita od dodira kontakta

SOCKET SCHUKO 2P+E 16A 250V~ __ XO

- screw contacts 1.5-2.5mm²
- XO without surround
- 2P+E schuko
- 16A 250V~, type VQ10
- shuttered live contacts



UTIČNICA ŠUKO+POKLOPAC 2P+E 16A 250V~ __ XO

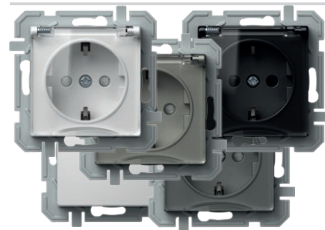

- VQ11PTXO
- VQ11TTXO
- VQ11ATXO
- VQ11BTXO

- VQ11PPXO
- VQ11TIXO
- VQ11AAXO
- VQ11BBXO

- vijčano pričvršćivanje vodiča 1.5-2.5mm²
- XO bez okvira
- 2P+E šuko+poklopac
- 16A 250V~, tip VQ11
- zaštita od dodira kontakta

SOCKET SCHUKO+COVER 2P+E 16A 250V~ __ XO

- screw contacts 1.5-2.5mm²
- XO without surround
- 2P+E schuko+cover
- 16A 250V~, type VQ11
- shuttered live contacts



UTIČNICA ŠUKO 2P+E 16A 250V~ BV __ XO

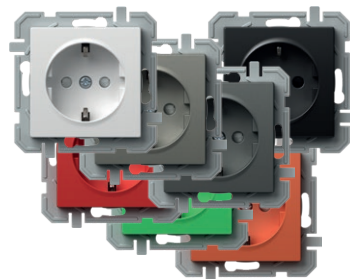

- VQ12PWXO
- VQ12TIXO
- VQ12ATXO
- VQ12BKXO

- VQ12RDXO
- VQ12GRXO
- VQ12ORXO

- BV bezvijčano pričvršćivanje vodiča 1.5-2.5mm²
- XO bez okvira
- 2P+E šuko
- 16A 250V~, tip VQ12
- zaštita od dodira kontakta

SOCKET SCHUKO 2P+E 16A 250V~ BV __ XO

- BV plug-in contacts 1.5-2.5mm²
- XO without surround
- 2P+E schuko
- 16A 250V~, type VQ12
- shuttered live contacts





- VQ13PTXO
- VQ13TTXO
- VQ13ATXO
- VQ13BTXO

- VQ13PPXO
- VQ13TIXO
- VQ13AAXO
- VQ13BBXO

UTIČNICA ŠUKO+POKLOPAC 2P+E 16A 250V~ BV __ XO

- BV bezvijačno pričvršćivanje vodiča 1.5-2.5mm²
- XO bez okvira
- 2P+E šuko+poklopac
- 16A 250V~, tip VQ13
- zaštita od dodira kontakta

SOCKET SCHUKO+COVER 2P+E 16A 250V~ BV __ XO

- BV plug-in contacts 1.5-2.5mm²
- XO without surround
- 2P+E schuko+cover
- 16A 250V~, type VQ13
- shuttered live contacts



- VQ16PW
- VQ16TI
- VQ16AT
- VQ16BK

UTIČNICA ŠUKO DVOSTRUKA 2P+E 16A 250V~

- 2P+E šuko dvostruka
- 16A 250V~, tip VQ16
- usklađeno s normom IEC 60884-1, CEE7
- vijčano pričvršćivanje vodiča 1.5-2.5mm²
- zaštita od dodira kontakta

SOCKET SCHUKO DOUBLE 2P+E 16A 250V~

- 2P+E schuko double
- 16A 250V~, type VQ16
- in accordance with IEC 60884-1, CEE7
- screw contacts 1.5-2.5 mm²
- shuttered live contacts



- VQ16PWF
- VQ16TIF
- VQ16ATF
- VQ16BKF

UTIČNICA ŠUKO DVOSTRUKA 2P+E 16A 250V~

- 2P+E šuko dvostruka
- 16A 250V~, tip VQ16
- usklađeno s normom IEC 60884-1, CEE7
- vijčano pričvršćivanje vodiča 1.5-2.5mm²
- zaštita od dodira kontakta

SOCKET SCHUKO DOUBLE 2P+E 16A 250V~

- 2P+E schuko double
- 16A 250V~, type VQ16
- in accordance with IEC 60884-1, CEE7
- screw contacts 1.5-2.5 mm²
- shuttered live contacts

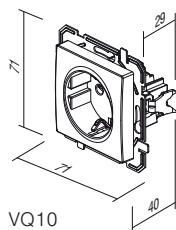

VQ10

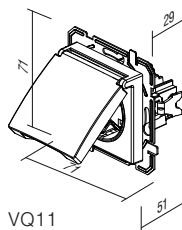

VQ11

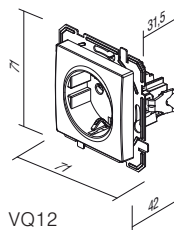

VQ12

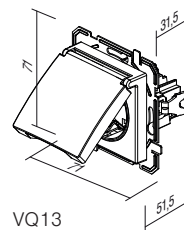

VQ13

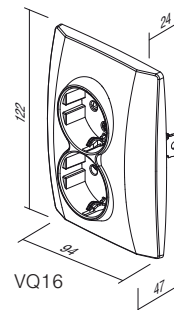

VQ16

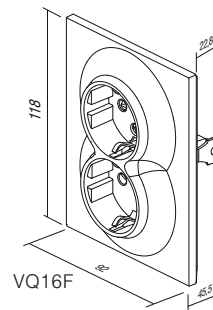

VQ16F

UTIČNICA FRANCUSKA 2P + E 16A 250V ~

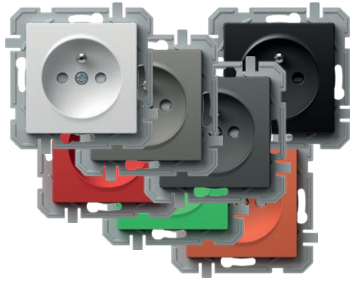

- VQ40PWXO
- VQ40TIXO
- VQ40ATXO
- VQ40BKXO

- VQ40RDXO
- VQ40GRXO
- VQ40ORXO

- vijčano pričvršćivanje vodiča presjeka 1.5-2.5mm²
- 2P+E francuska
- 16A 250V~, tip VQ40
- utičnica s integriranom zaštitom



SOCKET FRENCH 2P+E 16A 250V~ __ XO

- screw contacts 1.5-2.5mm²
- XO without surround
- 2P+E French
- 16A 250V~, type VQ40
- shuttered live contacts

UTIČNICA FRANCUSKA + POKLOPAC 2P + E 16A 250V~ __ XO



- VQ41PTXO
- VQ41TTXO
- VQ41ATXO
- VQ41BKXO

- VQ41PPXO
- VQ41TIXO
- VQ41AAXO
- VQ41BBXO

- vijčano pričvršćivanje vodiča presjeka 1,5-2,5mm²
- XO bez okvira
- 2P+E francuska+poklopac
- 16A 250V~, tip VQ41
- utičnica s integriranom zaštitom



SOCKET FRENCH+COVER 2P+E 16A 250V~ __ XO

- screw contacts 1.5-2.5mm²
- XO without surround
- 2P+E French+cover
- 16A 250V~, type VQ41
- shuttered live contacts

UTIČNICA FRANCUSKA 2P + E 16A 250V~ BV __ XO

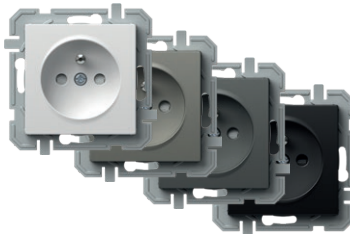

- VQ42PWXO
- VQ42TIXO
- VQ42ATXO
- VQ42BKXO

- BV bezvijčani kontakti 1,5-2,5mm²
- XO bez okvira
- utičnica s integriranom zaštitom
- 16A 250V~, tip VQ42



SOCKET FRENCH 2P+E 16A 250V~ BV __ XO

- BV plug-in contacts 1.5-2.5mm²
- XO without surround
- 2P+E French
- 16A 250V~, type VQ42
- shuttered live contacts

UTIČNICA FRANCUSKA + POKLOPAC 2P + E 16A 250V~ BV __ XO



- VQ43PTXO
- VQ43TTXO
- VQ43ATXO
- VQ43BKXO

- VQ43PPXO
- VQ43TIXO
- VQ43AAXO
- VQ43BBXO

- BV bezvijčani kontakti 1,5-2,5mm²
- XO bez okvira
- 2P+E francuska+poklopac
- 16A 250V~, tip VQ43
- utičnica s integriranom zaštitom



SOCKET FRENCH+COVER 2P+E 16A 250V~ BV __ XO

- BV plug-in contacts 1.5-2.5mm²
- XO without surround
- 2P+E French+cover
- 16A 250V~, type VQ43
- shuttered live contacts



- VQ46PW
- VQ46TI
- VQ46AT
- VQ46BK

UTIČNICA FRANCUSKA DVOSTRUKA 2P + E 16A 250V~

- 2P + E francuska dvostruka
- 16A 250V~, tip VQ46
- sukladno normama IEC 60884-1, CEE7; NF C 61-314, ČSN 33 2318; PN-E 93201
- vijčano pričvršćivanje vodiča presjeka 1,5-2,5 mm²
- utičnica s integriranom zaštitom

SOCKET FRENCH DOUBLE 2P+E 16A 250V~

- 2P+E French double
- 16A 250V~, type VQ46
- in accordance with IEC 60884-1, CEE7; NF C 61-314, ČSN 33 2318; PN-E 93201
- screw contacts 1,5-2,5 mm²
- shuttered live contacts



- VQ46PWF
- VQ46TIF
- VQ46ATF
- VQ46BKF

UTIČNICA FRANCUSKA DVOSTRUKA 2P + E 16A 250V~

- 2P + E francuska dvostruka
- 16A 250V~, tip VQ46
- sukladno normama IEC 60884-1, CEE7; NF C 61-314, ČSN 33 2318; PN-E 93201
- vijčano pričvršćivanje vodiča presjeka 1,5-2,5 mm²
- utičnica s integriranom zaštitom

SOCKET FRENCH DOUBLE 2P+E 16A 250V~

- 2P+E French double
- 16A 250V~, type VQ46
- in accordance with IEC 60884-1, CEE7; NF C 61-314, ČSN 33 2318; PN-E 93201
- screw contacts 1,5-2,5 mm²
- shuttered live contacts

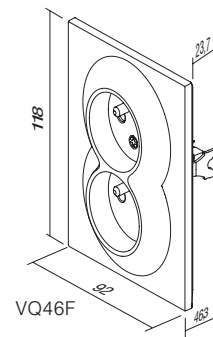
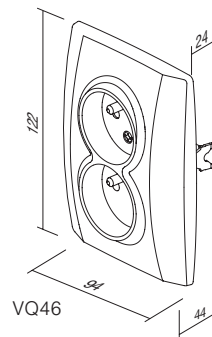
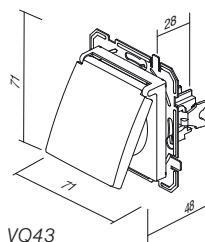
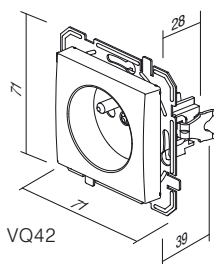
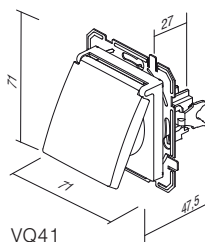
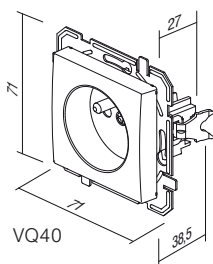



tip type	naziv description	tehnički opis technical data	boja colour	opsijski opis 1 optional data 1
KQ11	UTIČNICA TV-R ZAVRŠNA SOCKET TV-R END-LINE	1dB	<input type="checkbox"/> PW bijela – sjaj polar white	XO bez okvira without cover plate
KQ12	UTIČNICA TV-R PROLAZNA SOCKET TV-R THROUGHPASS	10dB	<input type="checkbox"/> TI titan titanium	
KQ16	UTIČNICA SAT-TV-R ZAVRŠNA SOCKET SAT-TV-R END-LINE	3dB	<input type="checkbox"/> AT antracit anthracite	
.	.	.	<input type="checkbox"/> BK crna black	



- KQ10PWXO
- KQ10TIXO
- KQ10ATXO
- KQ10BKXO

UTIČNICA TV OSNOVNA 0dB

- TV osnovna
- prigušenje 0dB
- stražnji konektor – F standard

SOCKET TV BASIC 0dB

- TV basic
- reduction 0dB
- back connector – F standard



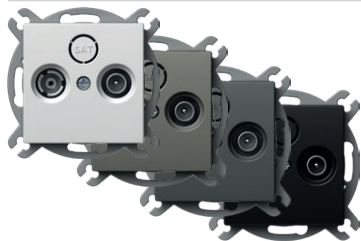

- KQ11PWXO
- KQ11TIXO
- KQ11ATXO
- KQ11BKXO

UTIČNICA TV-R ZAVRŠNA 1dB

- TV-R završna
- frekvenčni raspon 5÷862 MHz
- prigušenje: R-1.5dB, TV-1dB
- usklađeno s normom EN 50083-1
- vijčano priključenje

SOCKET TV-R END-LINE 1dB

- TV-R end-line
- frequency range 5÷862 MHz
- reduction: R-1.5dB, TV-1dB
- in accordance with EN 50083-1
- screw contact

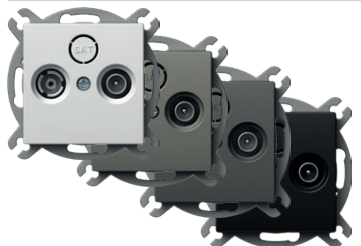

- KQ12PWXO
- KQ12TIXO
- KQ12ATXO
- KQ12BKXO

UTIČNICA TV-R PROLAZNA 10dB

- TV-R prolazna
- frekvenčni raspon 5÷862 MHz
- prigušenje: R-10dB, TV-10dB, prolaznost-2dB
- usklađeno s normom EN 50083-1
- vijčano priključenje

SOCKET TV-R TROUGHPASS 10dB

- TV-R troughpass
- frequency range 5÷862 MHz
- reduction: R-10dB, TV-10dB, trough-2dB
- in accordance with EN 50083-1
- screw contacts

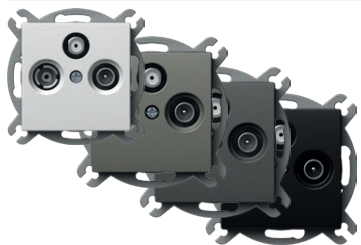

- KQ16PWXO
- KQ16TIXO
- KQ16ATXO
- KQ16BKXO

UTIČNICA SAT-TV-R ZAVRŠNA 3dB

- SAT-TV-R završna
- frekvenčni raspon 5÷2400 MHz
- prigušenje: R-1dB, TV-1.5dB, SAT-3dB
- usklađeno s normom EN 50083-1
- vijčano pričvršćivanje

SOCKET SAT-TV-R END-LINE 3dB

- SAT-TV-R end-line
- frequency range 5÷2400 MHz
- reduction: R-1dB, TV-1.5dB, SAT-3dB
- in accordance with EN 50083-1
- screw contacts



UTIČNICA AUDIO 2xRCA



- KQ22PWXO
- KQ22TIXO
- KQ22ATXO
- KQ22BKXO

- audio 2xRCA
- pričvršćivanje vodiča lemljenjem

SOCKET AUDIO 2xRCA

- audio 2xRCA
- soldering connection of cable



UTIČNICA AUDIO ZA ZVUČNIKE



- KQ23PWXO
- KQ23TIXO
- KQ23ATXO
- KQ23BKXO

- audio 2x Ø4mm
- za pričvršćivanje vodiča za zvučnike, utikača Ø4mm ili viljuškaste kableske stopice
- pričvršćivanje vodiča lemljenjem sa stražnje strane

SOCKET AUDIO LOUDSPEAKERS

- audio 2x Ø4mm
- to accommodate speaker wire, banana plug Ø4mm or spades
- soldering connection of cable at the back side



UTIČNICA TEL KS RJ11 6/4



- KQ36PWXO
- KQ36TIXO
- KQ36ATXO
- KQ36BKXO

- KS keystone standard pričvršćivanja
- RJ11 6/4
- usklađeno s normom IEC 60603-7

SOCKET TEL KS RJ11 6/4

- KS keystone fixing standard
- RJ11 6/4
- in accordance with IEC 60603-7



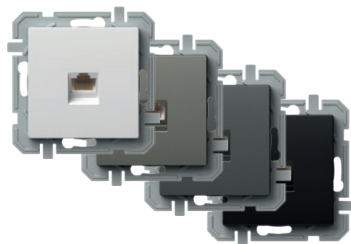

- KQ37PWXO
- KQ37TIXO
- KQ37ATXO
- KQ37BKXO

UTIČNICA CAT5e KS RJ45 8/8

- KS keystone standard pričvrščivanja
- CAT5e, RJ45 8/8
- usklađeno s normom IEC 60603-7

SOCKET CAT5e KS RJ45 8/8

- KS keystone fixing standard
- CAT5e, RJ45 8/8
- in accordance with IEC 60603-7



- KQ38PWXO
- KQ38TIXO
- KQ38ATXO
- KQ38BKXO

UTIČNICA TEL KS DVOSTRUKA 2x RJ11 6/4

- KS keystone standard pričvrščivanja
- 2x RJ11, 6/4
- usklađeno s normom IEC 60603-7

SOCKET TEL KS DOUBLE 2x RJ11 6/4

- KS keystone fixing standard
- 2x RJ11, 6/4
- in accordance with IEC 60603-7

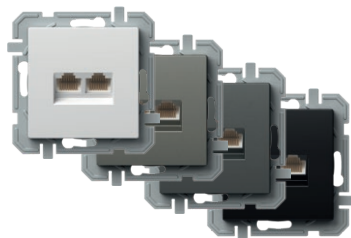

- KQ39PWXO
- KQ39TIXO
- KQ39ATXO
- KQ39BKXO

UTIČNICA CAT5e KS DVOSTRUKA 2x RJ45 8/8

- KS keystone standard pričvrščivanja
- 2x CAT5e, RJ45 8/8
- usklađeno s normom IEC 60603-7

SOCKET CAT5e KS DOUBLE 2x RJ45 8/8

- KS keystone fixing standard
- 2x CAT5e, RJ45 8/8
- in accordance with IEC 60603-7



UTIČNICA TEL LT RJ11 6/4



- KQ35PWXO
- KQ35TIXO
- KQ35ATXO
- KQ35BKXO

- TEL LT vijak
- vijčano pričvršćivanje vodiča
- RJ11 6/4
- usklađeno s normom IEC 60603-7

SOCKET TEL LT RJ11 6/4

- TEL LT screw
- screw contacts
- RJ11 6/4
- in accordance with IEC 60603-7



UTIČNICA CAT6 KS RJ45 8/8



- KQ40PWXO
- KQ40TIXO
- KQ40ATXO
- KQ40BKXO

- KS keystone standard pričvršćivanja
- CAT6, RJ45 8/8
- usklađeno s normom IEC 60603-7

SOCKET CAT6 KS RJ45 8/8

- KS keystone fixing standard
- CAT6, RJ45 8/8
- in accordance with IEC 60603-7



UTIČNICA CAT6 KS DVOSTRUKA 2x RJ45 8/8



- KQ41PWXO
- KQ41TIXO
- KQ41ATXO
- KQ41BKXO

- KS keystone standard pričvršćivanja
- 2x CAT6, RJ45 8/8
- usklađeno s normom IEC 60603-7

SOCKET CAT6 KS DOUBLE 2x RJ45 8/8

- KS keystone fixing standard
- 2x CAT6, RJ45 8/8
- in accordance with IEC 60603-7

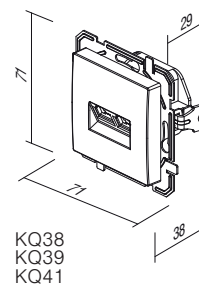
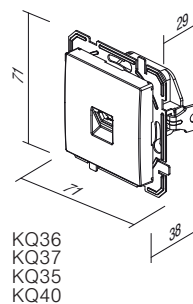
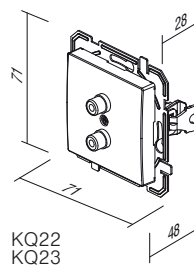
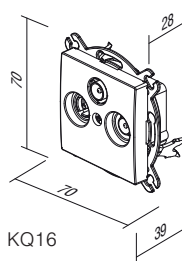
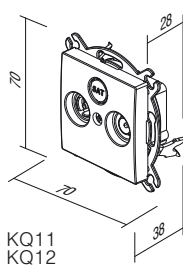
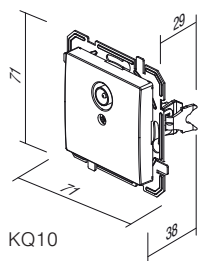



EQ15 PW XO

tip type	naziv description	tehnički podatci technical data	boja colour	opcijski opis 1 optional data 1
EQ15	ZATAMNJIVAČ ROTACIJSKI IZMJEN DIMMER ROTATIVE 2WAY	RL 400W	<input type="checkbox"/> PW bijela – sjaj polar white	XO bez okvira without cover plate
EQ16	ZATAMNJIVAČ ROTACIJSKI IZMJEN DIMMER ROTATIVE 2WAY	RLC 400W	<input type="checkbox"/> TI titan titanium	
EQ19	ZATAMNJIVAČ ROTACIJSKI IZMJEN DIMMER ROTATIVE 2WAY	LED 100W	<input type="checkbox"/> AT antracit anthracite	
·	·	·	<input type="checkbox"/> BK crna black	
·	·	·		



- EQ15PWXO
- EQ15TIXO
- EQ15ATXO
- EQ15BKXO

ZATAMNJIVAČ ROTACIJSKI IZMJEN RL 400W

- rotacijski s izmjeničnom sklopkom
- opterećenje RL, 40W – 400W
- mogućnost povezivanja s izmjeničnom sklopkom
- nije dopušteno povezivanje više zatamnivača
- usklađeno s normama EN 60669-1 i EN 60669-2-1
- bezvijačno pričvršćivanje vodiča 1.5-2.5mm²
- napajanje 230 V~ 50 Hz
- priložen zamjenjivi osigurač

DIMMER ROTATIVE 2WAY RL 400W

- rotation control with 2-way switch
- load RL, 40W - 400W
- 2-way switch combination is possible
- more dimmers combination is not allowed
- in accordance with EN 60669-1 and EN 60669-2-1
- plug-in contacts 1.5mm²
- supply 230V~ 50Hz
- replaceable fuse included



ZATAMNJIVAČ ROTACIJSKI IZMJEN RLC 400W

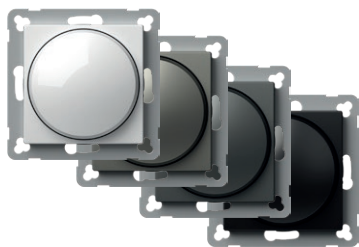

- EQ16PWXO
- EQ16TIXO
- EQ16ATXO
- EQ16BKXO

- rotacijski s izmjeničnom sklopkom
- opterećenje RLC, 20W – 400W
- mogućnost povezivanja s izmjeničnom sklopkom
- nije dopušteno povezivanje više zatamnivača
- usklađen s normama EN 60669-1 i EN 60669-2-1
- bezvijačno pričvršćivanje vodiča 1.5mm²
- napajanje 230V~ 50 Hz
- elektronski osigurač



DIMMER ROTATIVE 2WAY RLC 400W

- rotation control with 2-way switch
- load RLC, 20W - 400W
- 2-way switch combination is possible
- more dimmers combination is not allowed
- in accordance with EN 60669-1 and EN 60669-2-1
- plug-in contacts 1.5mm²
- supply 230V~ 50Hz
- electronic fuse

ZATAMNJIVAČ ROTACIJSKI IZMJEN LED 100W



- EQ19PWXO
- EQ19TIXO
- EQ19ATXO
- EQ19BKXO

- rotacijski s izmjeničnom sklopkom
- opterećenje: LED, 0-100W (max. 10 LED tinjalica)
GLS, 10-250W
- mogućnost povezivanja s izmjeničnom sklopkom
- nije dopušteno povezivanje više zatamnivača
- usklađeno s normama EN 60669-1 i EN 60669-2-1
- bezvijačno pričvršćivanje vodiča 1.5-2.5mm²
- napajanje 230V~ 50 Hz
- priložen zamjenjivi osigurač



DIMMER ROTATIVE 2WAY LED 100W

- rotation control with 2-way switch
- load: LED, 0-100W (max. 10 LEDs)
GLS, 10-250W
- 2-way switch combination is possible
- more dimmers combination is not allowed
- in accordance with EN 60669-1 and EN 60669-2-1
- plug-in contacts 1.5mm²
- supply 230V~ 50Hz
- replaceable fuse included

EQ15, EQ16, EQ19

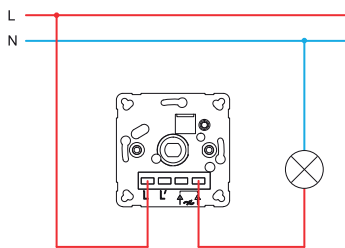

EQ15, EQ16, EQ19

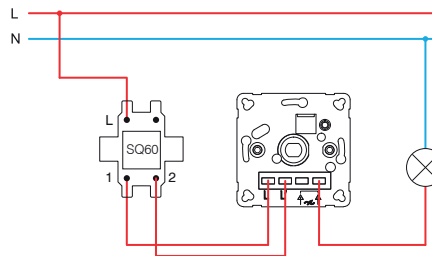

EQ15, EQ16, EQ19

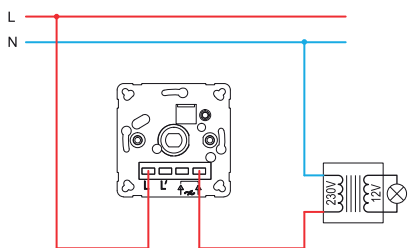

EQ15, EQ16, EQ19

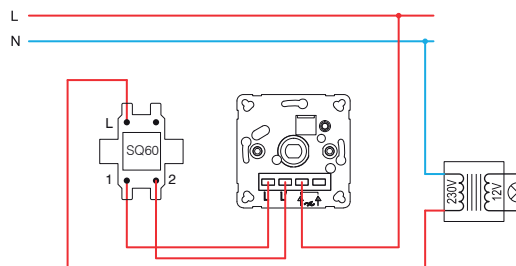

EQ16, EQ19

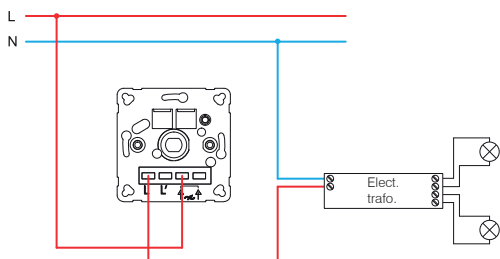

EQ16, EQ19

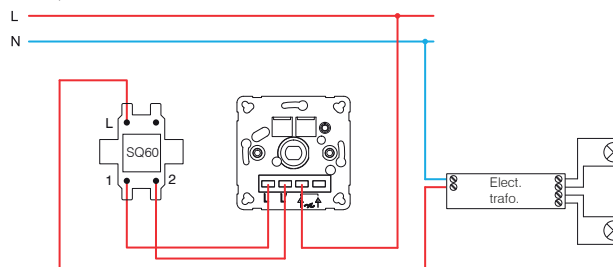

EQ15 (40÷400W)

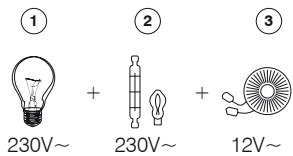

- 1 - žarulja sa žarnom niti / incandescent lamp
- 2 - halogena žarulja / halogen lamp

EQ16 (20÷400W)

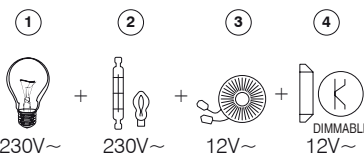

- 3 - klasični transformator / classical transformer
- 4 - elektronički transformator s mogućnošću prigušivanja / dimmable electronic transformer

EQ19 (GLS 10÷250W ; LED 0÷100W)

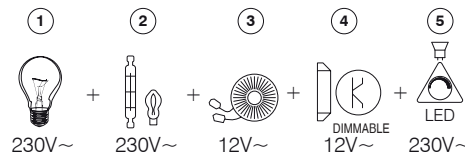

- 5 - LED tinjalica s regulacijom osvjettjenja / dimmable LED lamp



- EQ32PWXO
- EQ32TIXO
- EQ32ATXO
- EQ32BKXO

IR SKLOPKA 5A 230V~

- IR infracrvena sklopka
- napajanje: 230V~ ±10 % 50Hz
- Rele :5A/250V~ (zero crossing)
- razina zaštite: IP40
- presjek žica na kontaktnom terminalu: 0,75 – 2,5 mm²
- kut prepoznavanja: do 110° pri 20°C
- raspon prepoznavanja: približno 8 m pri 20°C
- prilagodljivost vremenskog trajanja: od približno 5 s do 12 min
- prilagodljivost osvjetljenja: od približno 5 do 200 LUX
- radna temperatura: od 0°C do +40°C
- nije prikladan za ugradnju u doze duboke 45 mm
- samo za unutrašnju uporabu

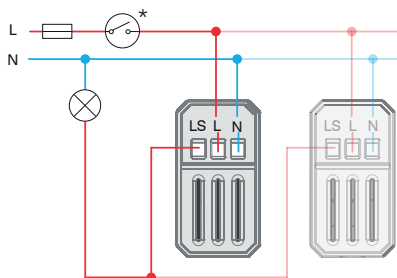

IR SWITCH 5A 230V~

- IR infrared switch
- supply voltage: 230V~ ±10 % 50Hz
- Relay :5A/250V~ (zero crossing)
- protection rating: IP40
- cross-section of wires at the contact terminal: 0.75 - 2.5 mm²
- detection angle: up to 110° at 20°C
- detection area: approx. 8 m at 20°C
- adjustability of duration: from approx. 5 s to 12 min
- adjustability of brightness: from approx. 5 to 200 LUX
- operating temperature: from 0°C to +40°C
- not suitable for installation in 45 mm deep boxes
- only for indoor usage

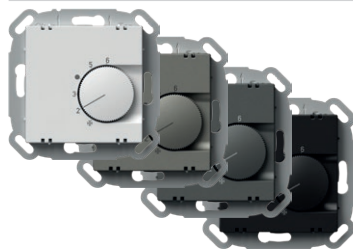

- EQ35PWXO
- EQ35TIXO
- EQ35ATXO
- EQ35BKXO

TERMOSTAT GRIJANJE 10A 230V~

- načina rada: grijanje
- napajanje: 230 V~, 50 Hz
- izlaz: 4 A (max. 10 A), 230 V~, 50 Hz
- izlazni priključak: NC (max. 10 aktuatora)
- raspon regulacije: od +5 °C do +30 °C
- histereza: 0,5 K
- zaštita: IP30
- vrsta senzora: bimetal
- vrsta električnog priključka: opružni kontakti
- vrsta vodiča:
0,75 – 1,5mm² (meka žica) ali
1,0 – 2,5 mm²(tvrda žica)

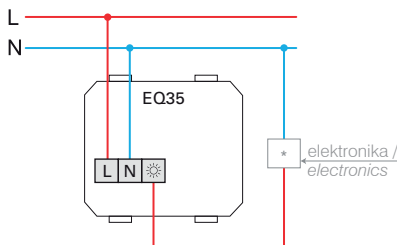

THERMOSTAT HEATING 10A 230V~

- operation mode: heating
- power supply: 230 V~, 50 Hz
- output: 4 A (max. 10 A), 230 V~, 50 Hz
- switching contact: NC (max. 10 actuators)
- regulation range: +5 °C to +30 °C
- hysteresis: 0,5 K
- protection: IP30
- sensor type: bimetal
- type of electrical connection: spring-loaded contacts
- type of conductors:
0,75 – 1,5mm² (flexible-stranded core) or
1,0 – 2,5 mm² (solid core)

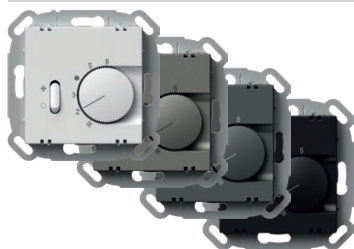

- EQ36PWXO
- EQ36TIXO
- EQ36ATXO
- EQ36BKXO

TERMOSTAT GRIJANJE / HLAĐENJE 5A 230V~

- načina rada: grijanje / hlađenje
- napajanje: 230 V~, 50 Hz
- izlaz: 2 A (max. 5 A), 230 V~, 50 Hz
- izlazni priključak: preklopna sklopka (max. 5 aktuatora)
- raspon regulacije: od +5 °C do +30 °C
- histereza: 0,5 K
- zaštita: IP30
- vrsta senzora: bimetal
- vrsta električnog priključka: opružni kontakti
- vrsta vodiča: 0,75 – 1,5 mm² (meka žica) ili 1,0 – 2,5 mm² (tvrda žica)

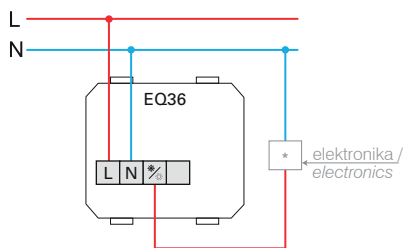

THERMOSTAT HEATING / COOLING 5A 230V~

- operation mode: heating / cooling
- power supply: 230 V~, 50 Hz
- output: 2 A (max. 5 A), 230 V~, 50 Hz
- switching contact: changeover switch (toggler, max. 5 actuators)
- regulation range: +5 °C to +30 °C
- hysteresis: 0,5 K
- protection: IP30
- sensor type: bimetal
- type of electrical connection: spring-loaded contacts
- type of conductors: 0,75 – 1,5mm² (flexible-stranded core) or 1,0 – 2,5 mm² (solid core)

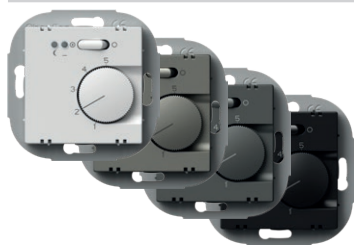

- EQ37PWXO
- EQ37TIXO
- EQ37ATXO
- EQ37BKXO

TERMOSTAT PODNO GRIJANJE 16A 230V~

- način rada: podno grijanje
- napajanje: 230 V~, 50 Hz
- izlaz: 2 A (max. 16 A), 230 V~, 50 Hz
- raspon regulacije: od +10 °C do +50 °C
- histereza: 1 K
- zaštita: IP30
- vrsta senzora: NTC u skladu s DIN EN 60730-2-1
- indikatori: crvena LED za grijanje i zelena LED za noćni način sa smanjenom funkcionalnošću
- vrsta električnog priključka: vijčani kontakti
- vrsta vodiča: 0,5 – 2,5 mm²

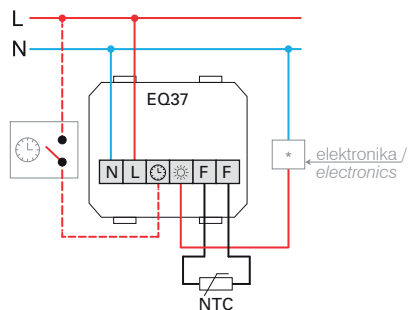

THERMOSTAT FLOOR HEATING 16A 230V~

- operation mode: floor heating
- power supply: 230 V~, 50 Hz
- output: 2 A (max. 16 A), 230 V~, 50 Hz
- regulation range: +10 °C to +50 °C
- hysteresis: 1 K
- protection: IP30
- sensor type: NTC in compliance with DIN EN 60730-2-1
- indicators: Red LED for heating and green LED for night decrease mode
- type of electrical connection: Screw contacts
- type of conductors: 0,5 – 2,5mm²

TERMOSTAT GRIJANJE / HLAĐENJE 5A 230~



- EQ68PWXO
- EQ68TIXO
- EQ68ATXO
- EQ68BKXO

- načina rada: grijanje / hlađenje
- napajanje: 230 V~, 50 Hz
- izlaz: 2 A (max. 5 A), 230 V~, 50 Hz
- izlazni priključak: preklopna sklopka (max. 5 aktuatora)
- raspon regulacije: od +5°C do +30°C
- histereza: 0,5 K
- zaštita: IP30
- vrsta senzora: bimetal
- vrsta električnog priključka: opružni kontakti
- vrsta vodiča: 0,75 – 1,5 mm²(meka žica) ili 1,0 – 2,5 mm²(tvrda žica)

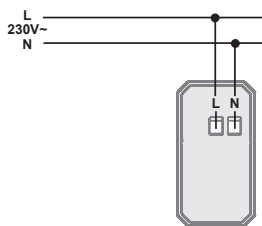

elektronika /
electronics

USB POWER SUPPLY UNIT 5V 3.0A

- for charging electronic devices via a standard USB port (also compatible with Apple devices)
- power supply: 100-230V~ 50/60Hz
- power consumption: 300mA at 100V~/150mA at 230V~
- standby power consumption: 30mW at 230V~
- nominal output voltage: 5 VCD (± 5%) SELV
- output ripple voltage: 150mV
- nominal output current: 3.0 A (±10%)
- connector type: USB A / USB C
- efficiency: maximum of 77%
- operating temperature: 0°C/+45°C (indoor use)
- IP protection class: IP20, indoor use only
- class device II
- overvoltage category (EN 62109): Class III
- screw contacts: max. 2.5 mm²
- device with a contact gap of at least 3mm
- in accordance with the EN 60950-1 and LVD & EMC directives

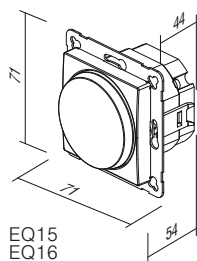

EQ15
EQ16
EQ19

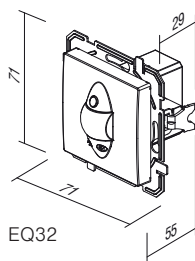

EQ32

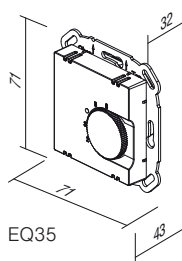

EQ35

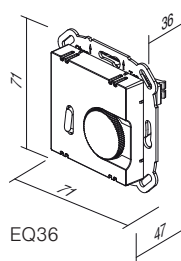

EQ36

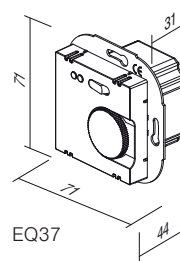

EQ37

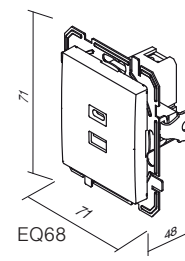

EQ68

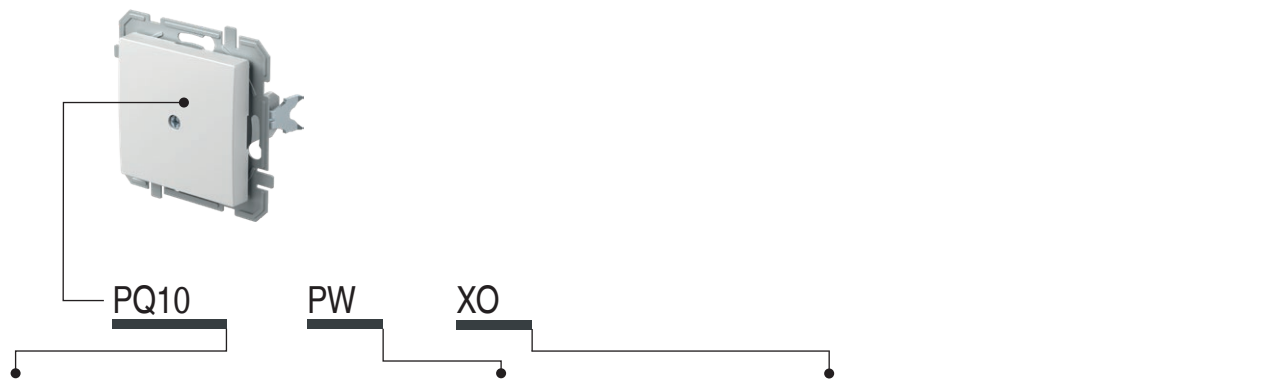

tip type	naziv description	boja colour	opcijski opis 1 optional data 1
PQ10	PUNILO BLANK	<input type="checkbox"/> PW bijela – sjaj polar white	XO bez okvira without cover plate
PQ30	POKLOPAC TAE/TDO COVER TAE/TDO	<input type="checkbox"/> TI titan titanium <input type="checkbox"/> AT antracit anthracite <input type="checkbox"/> BK crna black	

PUNILO



- PQ10PWXO
- PQ10TIXO
- PQ10ATXO
- PQ10BKXO

- za pokrivanje praznih otvora
BLANK
- for filling up empty spaces



POKLOPAC TAE/TDO

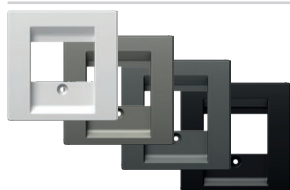

- PQ30PW
- PQ30TI
- PQ30AT
- PQ30BK

- TAE ili TDO poklopac s vijkom
COVER TAE/TDO
- TAE or TDO cover with screw

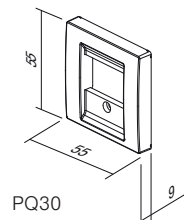
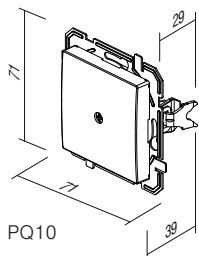

OKVIRI BOLD OQ

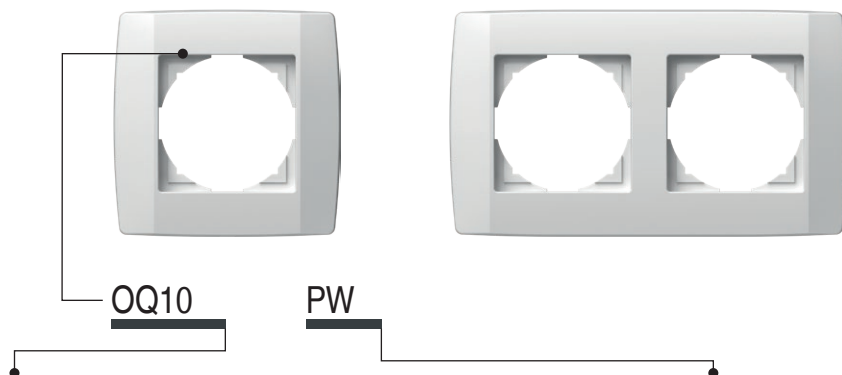

tip type	naziv description	boja colour
OQ10	OKVIR BOLD 1 COVER PLATE BOLD 1	PW bijela – sjaj polar white
OQ20	OKVIR BOLD 2 COVER PLATE BOLD 2	TI titan titanium
OQ30	OKVIR BOLD 3 COVER PLATE BOLD 3	AT antracit anthracite
:	:	BK black
:	:	



	OQ10PW
	OQ10TI
	OQ10AT
	OQ10BK

OKVIR BOLD 1

- dekorativni pojedinačni okvir
- usklađeno s normom EN 60669-1

COVER PLATE BOLD 1

- decorative cover plate 1-gang
- in accordance with EN 60669-1

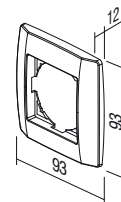

	OQ20PW
	OQ20TI
	OQ20AT
	OQ20BK

OKVIR BOLD 2

- dekorativni dvostruki okvir
- u skladu s EN 60669-1

COVER PLATE BOLD 2

- decorative cover plate 2-gang
- in accordance with EN 60669-1

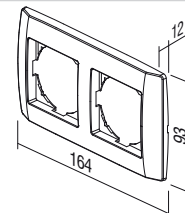



- QQ30PW
- QQ30TI
- QQ30AT
- QQ30BK

OKVIR BOLD 3

- dekorativni trostruki okvir
- u skladu s EN 60669-1

COVER PLATE BOLD 3

- decorative cover plate 3-gang
- in accordance with EN 60669-1

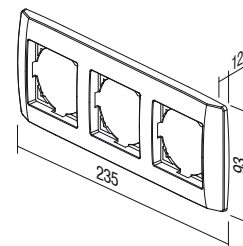

- QQ40PW
- QQ40TI
- QQ40AT
- QQ40BK

OKVIR BOLD 4

- dekorativni četverostruki okvir
- u skladu s EN 60669-1

COVER PLATE BOLD 4

- decorative cover plate 4-gang
- in accordance with EN 60669-1

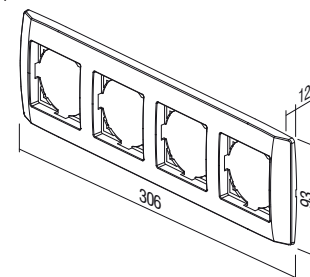

- QQ50PW
- QQ50TI
- QQ50AT
- QQ50BK

OKVIR BOLD 5

- dekorativni peterostruki okvir
- u skladu s EN 60669-1

COVER PLATE BOLD 5

- decorative cover plate 5-gang
- in accordance with EN 60669-1

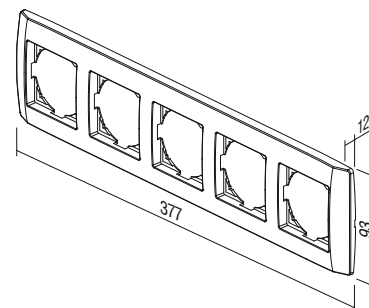



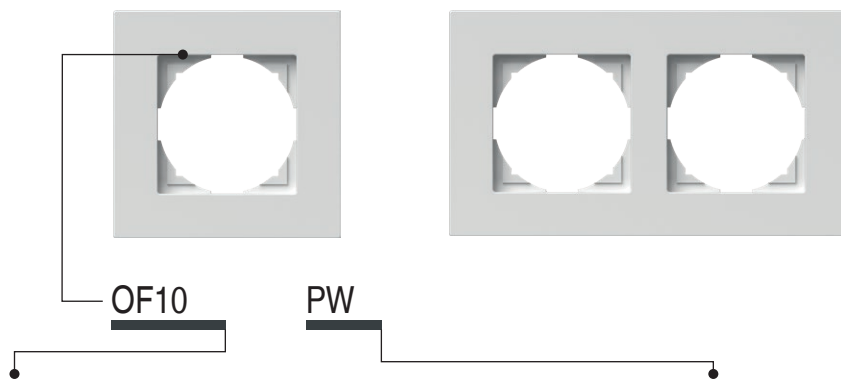

O K V I R I F L A T O F



tip type	naziv description	boja colour
OF10	OKVIR FLAT 1 COVER PLATE FLAT 1	 PW bijela – sjaj polar white
OF20	OKVIR FLAT 2 COVER PLATE FLAT 2	 TI titan titanium
OF30	OKVIR FLAT 3 COVER PLATE FLAT 3	 AT antracit anthracite
·	·	 BK crna black
·	·	



	OF10PW
	OF10TI
	OF10AT
	OF10BK





OKVIR FLAT 1

- dekorativni pojedinačni okvir
- usklađeno s normom EN 60669-1

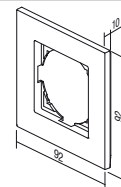
COVER PLATE FLAT 1

- decorative cover plate 1-gang
- in accordance with EN 60669-1



	OF20PW
	OF20TI
	OF20AT
	OF20BK

OKVIR FLAT 2

- dekorativni dvostruki okvir
- u skladu s EN 60669-1

COVER PLATE FLAT 2

- decorative cover plate 2-gang
- in accordance with EN 60669-1

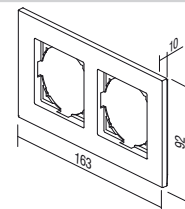

OKVIR FLAT 3



- OF30PW
- OF30TI
- OF30AT
- OF30BK

- dekorativni trostruki okvir
- u skladu s EN 60669-1

COVER PLATE FLAT 3

- decorative cover plate 3-gang
- in accordance with EN 60669-1

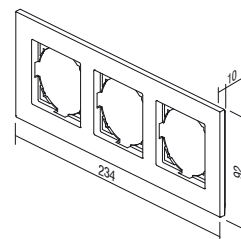

OKVIR FLAT 4



- OF40PW
- OF40TI
- OF40AT
- OF40BK

- dekorativni četverostruki okvir
- u skladu s EN 60669-1

COVER PLATE FLAT 4

- decorative cover plate 4-gang
- in accordance with EN 60669-1

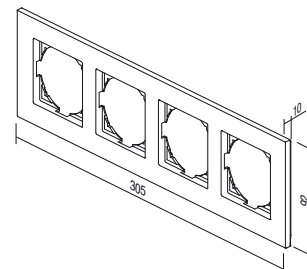

OKVIR FLAT 5



- OF50PW
- OF50TI
- OF50AT
- OF50BK

- dekorativni peterostruki okvir
- u skladu s EN 60669-1

COVER PLATE FLAT 5

- decorative cover plate 5-gang
- in accordance with EN 60669-1

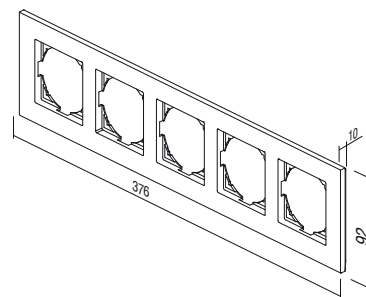

O K V I R I P R I M E O R

tip type	naziv description	boja colour
OR10	OKVIR PRIME 1 COVER PLATE PRIME 1	GL bijela glass light
OR20	OKVIR PRIME 2 COVER PLATE PRIME 2	GD crna glass dark
OR30	OKVIR PRIME 3 COVER PLATE PRIME 3	
⋮	⋮	
⋮	⋮	

OKVIR PRIME 1

OR10GL
 OR10GD

- dekorativni pojedinačni okvir
- usklađeno s normom EN 60669-1

COVER PLATE PRIME 1

- decorative cover plate 1-gang
- in accordance with EN 60669-1

OKVIR PRIME 2

OR20GL
 OR20GD

- dekorativni dvostruki okvir
- u skladu s EN 60669-1

COVER PLATE PRIME 2

- decorative cover plate 2-gang
- in accordance with EN 60669-1

OKVIR PRIME 3



OR30GL
OR30GD

- dekorativni trostruki okvir
- u skladu s EN 60669-1

COVER PLATE PRIME 3

- decorative cover plate 3-gang
- in accordance with EN 60669-1

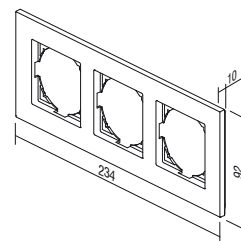

OKVIR PRIME 4



OR40GL
OR40GD

- dekorativni četverostruki okvir
- u skladu s EN 60669-1

COVER PLATE PRIME 4

- decorative cover plate 4-gang
- in accordance with EN 60669-1

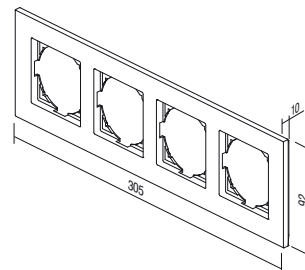

TEM
WWW.TEM.SI
JVE 2024

TEM Čatež d.o.o.
Čatež 13, 8212 Velika Loka
Slovenija
e: info@tem.si
w: www.tem.si
t: +386 (0)7 348 99 00

